

INFORMATION TO USERS

This manuscript has been reproduced from the microfilm master. UMI films the text directly from the original or copy submitted. Thus, some thesis and dissertation copies are in typewriter face, while others may be from any type of computer printer.

The quality of this reproduction is dependent upon the quality of the copy submitted. Broken or indistinct print, colored or poor quality illustrations and photographs, print bleedthrough, substandard margins, and improper alignment can adversely affect reproduction.

In the unlikely event that the author did not send UMI a complete manuscript and there are missing pages, these will be noted. Also, if unauthorized copyright material had to be removed, a note will indicate the deletion.

Oversize materials (e.g., maps, drawings, charts) are reproduced by sectioning the original, beginning at the upper left-hand corner and continuing from left to right in equal sections with small overlaps. Each original is also photographed in one exposure and is included in reduced form at the back of the book.

Photographs included in the original manuscript have been reproduced xerographically in this copy. Higher quality 6" x 9" black and white photographic prints are available for any photographs or illustrations appearing in this copy for an additional charge. Contact UMI directly to order.

UMI

**A Bell & Howell Information Company
300 North Zeeb Road, Ann Arbor MI 48106-1346 USA
313/761-4700 800/521-0600**

THE SYNTAX AND PROCESSING OF SCRAMBLING CONSTRUCTIONS
IN RUSSIAN

by

IRINA A. SEKERINA

A dissertation submitted to the Graduate Faculty in Linguistics
in partial fulfillment of the requirements for the degree of
Doctor of Philosophy, The City University of New York.

1997

UMI Number: 9807998

**Copyright 1997 by
Sekerina, Irina A.**

All rights reserved.

**UMI Microform 9807998
Copyright 1997, by UMI Company. All rights reserved.**

**This microform edition is protected against unauthorized
copying under Title 17, United States Code.**

UMI
300 North Zeeb Road
Ann Arbor, MI 48103

© 1997

IRINA A. SEKERINA

All Rights Reserved

This manuscript has been read and accepted for the Graduate Faculty in Linguistics in satisfaction of the dissertation requirement for the degree of Doctor of Philosophy.

Sept 22 1997
Date

Janet Sedov
Chair of Examining Committee

September 16, 1997
Date

Charles E. Cairns
Executive Officer

Dianne Bradley

Robert Fiengo 

Lyn Frazier

THE CITY UNIVERSITY OF NEW YORK

ABSTRACT
THE SYNTAX AND PROCESSING OF SCRAMBLING CONSTRUCTIONS IN
RUSSIAN

by

Irina A. Sekerina

Adviser: Professor Janet Dean Fodor

The dissertation examines word order variation in Russian due to Scrambling, which I take to be an instance of overt syntactic movement. I investigate two major types of Scrambling in Russian, clause-internal XP-Scrambling and Split Scrambling, from the point of view of syntactic structure, focus structure as related to discourse, and sentence processing.

Applying standard syntactic tests I identify grammatical characteristics of XP-Scrambling in Russian and argue that it is a mixed A'/A-movement phenomenon as observed in other scrambling languages. Two language-specific parameter values are proposed: In Russian, both VP- and IP-adjunctions serve as landing sites, and Scrambling can proceed both leftward and rightward. Split Scrambling produces discontinuous DPs (and PPs), i.e., phrases in which an adjective is not string-adjacent to the head noun it modifies. Split Scrambling in Russian obeys three additional constraints, the Periphery Constraint, the One-Split-per-Clause Constraint, and the Preposition-First Constraint. If these are

syntactic constraints, they motivate a Double-Movement analysis according to which first a DP (PP) is XP-scrambled into SPEC, F(ocus)P, and then N' (or A') is extracted out of it and is right-adjoined to FP. Two additional parameter values are proposed: the remnant does not stay *in situ*, and the extracted element can be of the category Y'. I propose that both types of Scrambling in Russian are obligatory in the sense that they are driven by Focus requirements, which are reflected also in stress assignment.

In four experiments reported here, I examine the applicability of two proposed universals of the Garden-Path model of sentence processing, the Minimal Chain Principle and the Minimal Revisions Principle, to processing of Russian scrambling constructions, and also test the Scrambling Complexity Hypothesis. The experimental findings provide evidence for the complexity of standard XP-Scrambling relative to canonical SVO word order, and even greater complexity of Split Scrambling compared to XP-Scrambling, as reflected in increased reading times for split-scrambled sentences in self-paced reading. These results are consistent with the principles of the Garden-Path theory and support the Scrambling Complexity Hypothesis. The possibility of processing origin for the One-Split-per-Clause Constraint and the Periphery Constraint is considered. For the former it is plausible; for the latter the experimental data tell against it.

ACKNOWLEDGMENTS

First and foremost, I would like to thank my dissertation committee without whom this dissertation would have been impossible: Professors Janet Dean Fodor, Lyn Frazier, Robert Fiengo, and Dianne Bradley.

I owe it to Janet Fodor that I became fascinated with psycholinguistics and syntactic sentence processing. My doubts about what linguistic field to pursue ended with the first introductory class in sentence processing I took with her. I am indebtedly grateful to Janet for her constant positive encouragement from my first crude term papers to complex dissertation experiments, for endless hours spent in linguistic discussions, for reading numerous versions of this dissertation, and providing important insights at crucial points. Last but not least I thank Janet for being there for me not only as a mentor, but also as a friend.

It has been great learning experience to work with Lyn Frazier. I am grateful to her for agreeing to be on my committee in the first place. On many occasions when I came to discuss my dissertation with Lyn at Amherst, it was her brainstorming sessions that produced so many of the ideas in this thesis. She has been always available when I needed her help, despite the physical distance and her extremely busy schedule. Lyn inspired me with her seemingly boundless capacity for work and comprehensive knowledge of linguistics. She made sure that I went over every relevant detail. Many hours spent in linguistic

and personal discussions in Lyn's hospitable home helped me get through the most strenuous times in my work.

I am obligated to Robert Fiengo for most of what I know about syntax. Ever since my first syntactic class with him when I was a first-year graduate student, we have had interesting discussions concerning different aspects of Russian syntax. I gratefully acknowledge his intellectual and moral support throughout all the years at the Graduate Center.

I am indebted to Dianne Bradley for the psycholinguistic part of this dissertation. She joined my committee after I had already started the dissertation. I did not realize until that moment that I would have never finished it without her. Di generously spent long hours discussing every aspect of the experimental design of my sentence processing experiments and painstakingly went through every number in the statistical analysis. She taught me everything I know about statistics, a rocky process, and managed to salvage over email across oceans from Australia my most hopeless experimental problems, while I was desperate in Moscow.

I would also like to thank other linguists who expressed interest in my work and helped me with their comments and suggestions. Tracy H. King was invaluable because of her unique knowledge of both the Russian language and Government-Binding theory. I gratefully acknowledge her thorough comments on Part II of this dissertation and advice on relevant readings in other Slavic

languages. The late R. M. R. Hall provided me with the important data from Indo-European languages. Janina Radó, Steven Franks, Sergey Avrutin, Ingeborg Lasser and Uwe Junghanns shared with me their unpublished manuscripts and constituted an audience for discussing different portions of this dissertation throughout its evolution.

In writing the syntactic chapters of this dissertation, I was influenced by the work of a fellow Russian linguist and a dear friend Natalia Kondrashova. Our long email messages and even longer discussions in person helped me better understand many important phenomena of Russian syntax. Natasha also provided an inspiring example in terms of successfully combining a busy linguistic career with taking care of a family.

My very special thanks go to Nora Aion, my colleague and personal friend throughout all the years at the Graduate School and University Center. Nora and her family have become my American family, providing me with years of moral support and help on many, many occasions. Most of all, Nora took time to painstakingly proof-read and comment on most of my work, beginning with the first term papers and ending with this dissertation. All this is deeply appreciated.

Experimental data used in this dissertation were collected among my personal friends and numerous students in Moscow. I thank them all: Irina Dmitrievna Krylova, her family and her students, Irina and Andrej Krylovs,

Svetlana Gavrilova, Natalia and Sergey Orekhovs, Tat'jana Morschakova and Vladimir Vingradov, Elena Smarzhevskaja and Andrej Davydov, Marina Gagarina and Alexey Lobov, Angelina Kadatskaja, Natalia and Galina Pjatnitskaja, and Svetlana L'vova.

Finally, my deepest gratitude goes to my husband and friend Dr. Paul R. Migliore. I owe it to him that I came to this country and managed to successfully apply to a graduate program. It was he who provided moral and financial support through my years of studies, who encouraged and applauded me at every step on the way and who consoled and helped at the most difficult times. Ultimately, Paul can take much credit for the fact that this dissertation has been written.

The research and writing of this dissertation were partially supported by the Distinguished Scholar Fellowship awarded by the CUNY Graduate School and University Center.

TABLE OF CONTENTS		<u>Page</u>
ABSTRACT		iii
LIST OF TABLES		xii
CHAPTER 1: INTRODUCTION		1
1.1	Overview of Dissertation	1
1.2	Outline of Following Chapters	21
PART I:	XP-SCRAMBLING: SYNTAX AND PROCESSING	24
CHAPTER 2:	SYNTACTIC PROPERTIES OF XP-SCRAMBLING	24
2.1	Introduction	25
2.2	Structure of the Russian Clause	27
	2.2.1 VSO (King, 1993)	29
	2.2.2 SVO (Bailyn, 1995)	30
2.3	Syntactic Movement in Russian	34
	2.3.1 Wh-Movement	34
	2.3.2 Topicalization, Cleft Construction with <i>èto</i> , and Left-Dislocation	37
	2.3.3 Right Extraposition	40
2.4	Syntactic Properties of XP-Scrambling in Russian	46
	2.4.1 Descriptive Characteristics of Surface Word Order Variation	46
	2.4.2 Syntactic Properties of Clause-Internal XP-Scrambling in Russian	51
	2.4.2.1 Anaphor Binding	52
	2.4.2.2 WCO	54
	2.4.2.3 Anaphor Preposing	57
	2.4.2.4 Condition C Reconstruction Effects (Strong Crossover)	58
	2.4.2.5 Parasitic Gaps	60
	2.4.2.6 Summary	61
2.5	Syntactic Properties of XP-Scrambling Cross-Linguistically	63
	2.5.1 XP-Scrambling as A'-Movement	64
	2.5.2 XP-Scrambling as A-Movement	67
	2.5.3 XP-Scrambling as Non-Uniform Movement	72
	2.5.4 Summary	75
2.6	Summary of Chapter 2	77
CHAPTER 3:	DISCOURSE PROPERTIES OF XP-SCRAMBLING	79
3.1	Introduction	80
3.2	XP-Scrambling and Focus (Reinhart, 1995)	81
3.3	Functional Analyses of XP-Scrambling	86
	3.3.1 Introduction	86
	3.3.2 XP-Scrambling as Discourse-Driven S-Structure Movement (King, 1993)	87
	3.3.3 Extraposition, IP- and VP-Adjunction and the Functional Form Hypothesis (Bailyn, 1995)	91
	3.3.4 F-Scrambling and N-Scrambling, and the I-Structure Hypothesis (Kondrashova, 1996)	97

3.3.5	Information-Structure (Junghanns and Zybatow, 1995)	102
3.3.6	Summary	105
3.4	XP-Scrambling in Russian and the Syntax-Phonology Interface	108
3.5	Summary of Chapter 3	118
CHAPTER 4: PROCESSING OF XP-SCRAMBLING		121
4.1	Introduction	122
4.2	Garden-Path Model of Sentence Processing.	124
4.2.1	Overview.	124
4.2.2	Processing of Scrambling Constructions in German (Bader, 1994)	130
4.2.3	Processing of Scrambling Constructions in Japanese (Yamashita, 1996)	132
4.3	Analysis of Russian Experimental Sentences with XP-Scrambling	133
4.3.1	The NOM/ACC Ambiguity	133
4.3.2	The INSTR Ambiguity.	137
4.3.3	The DAT Ambiguity	142
4.3.4	Summary	148
4.4	Experiment 1: Meaning Accessibility Judgments.	149
4.5	Experiment 2: Overall Sentence Reading	164
4.6	Summary of Chapter 4	179
PART II: SPLIT SCRAMBLING: SYNTAX AND PROCESSING		181
CHAPTER 5: SYNTACTIC PROPERTIES OF SPLIT SCRAMBLING		181
5.1	Introduction	182
5.2	Descriptive Properties of Split Scrambling in Russian.	185
5.2.1	Restrictions on Discontinuous DPs and PPs.	185
5.3	Syntactic Properties of Split Scrambling Cross-Linguistically	189
5.3.1	Historical Overview	190
5.3.2	PP and NP Breakup in Latin (Ostafin, 1986)	193
5.3.2.1	PP Breakup.	194
5.3.2.2	NP Breakup.	196
5.3.3	VP-Remnant Topicalization in German (Den Besten and Webelhuth, 1990)	198
5.3.4	PP-Remnant Topicalization in Serbo-Croatian (Franks and Progovac, 1994)	199
5.3.5	Split DP Focus Constructions in Modern Greek (Androutsopoulou, 1997)	205
5.4	Syntactic Accounts of Split Scrambling in Russian.	207
5.4.1	DP-Hypothesis and the <i>Barriers</i> Framework (Yearley, 1993)	208
5.4.2	Scrambling of Pieces of Phrases (Franks, 1993)	211
5.4.3	DP-Hypothesis, Left Branch Constraint and Subjacency (Bailyn, 1995)	213
5.4.4	Copy and Deletion (Junghanns and Zybatow, 1995)	214
5.4.5	Summary	216
5.5	The Double-Movement Analysis of Split Scrambling in Russian	217
5.6	Summary of Chapter 5	224
CHAPTER 6: DISCOURSE PROPERTIES OF SPLIT SCRAMBLING		226
6.1	Introduction	227
6.2	Functional Analyses of Discourse Properties of Word Order Variation in the	228

Russian DP	228
6.2.1 Production Data: Sirotinina (1965)	228
6.2.2 Discourse Functions of Discontinuous DPs: Lapteva (1976)	234
6.3 Functional Analysis of Split Scrambling in Polish (Siewierska, 1984)	238
6.4 Split Scrambling in Russian and the Syntax-Phonology Interface	243
6.4.1 Split Scrambling and Focus	243
6.4.2 The Periphery Constraint and the One-Split-per-Clause Constraint	248
6.5 Summary of Chapter 6	251
 CHAPTER 7: PROCESSING OF SPLIT SCRAMBLING	 253
7.1 Introduction	254
7.2 Syntax and Processing of Russian Experimental Sentences with Split Scrambling ..	255
7.2.1 General Remarks	255
7.2.2 Analysis of Experimental Sentences	258
7.3 Experiment 3: Chunk-by-Chunk Self-Paced Reading	267
7.4 Experiment 4: Sentence Completion Study	280
7.5 Informants' Comments	294
7.6 Summary of Chapter 7	296
 APPENDICES	 298
APPENDIX 1: Experimental materials for Experiment 1	298
APPENDIX 2: Experimental materials for Experiment 2	302
APPENDIX 3: Experimental materials for Experiment 3	307
APPENDIX 4: Experimental materials for Experiment 4	314
 REFERENCES	 323

LIST OF TABLES

CHAPTER 2

TABLE 1.	Tests for Syntactic Characteristics of Landing Site for XP-Scrambling in Japanese (Takahashi, 1995)	52
TABLE 2.	Syntactic Properties of XP-Scrambling in Russian with Respect to the Landing Site	61
TABLE 3.	Properties of S-, M- and L-Scrambling in Japanese	75

CHAPTER 3

TABLE 4.	Comparison of the Four Approaches to Discourse-Relevant Status of Constituents.	104
TABLE 5.	Comparison of the Four Functional Approaches to Word Order Variations in Russian	106

CHAPTER 4

TABLE 6.	NOM/ACC Ambiguity: Mean Rated Accessibility, as a Function of Reading and Word Order	155
TABLE 7.	INSTR Ambiguity: Mean Rated Accessibility, as a Function of Reading and Word Order	157
TABLE 8.	DAT Ambiguity: Mean Rated Accessibility, as a Function of Reading and Word Order	160
TABLE 9.	NOM/ACC Ambiguity: Comprehension Responses (percent, for each type) and Sentence Reading Type (in seconds, percent timeouts in parentheses), as a Function of Word Order	173
TABLE 10.	INSTR Ambiguity: Comprehension Responses (percent, for each type) and Sentence Reading Type (in seconds, percent timeouts in parentheses), as a Function of Word Order.	175
TABLE 11.	DAT Ambiguity: Comprehension Responses (percent, for each type) and Sentence Reading Type (in seconds, percent timeouts in parentheses), as a Function of Word Order.	177

CHAPTER 5

TABLE 12.	Restrictions on Split Scrambling in Russian	188
TABLE 13.	Comparison of Theoretical Approaches to Split Scrambling Cross-Linguistically	216

CHAPTER 6.

TABLE 15.	Word Orders in Colloquial Russian DP (Sirotnina, 1965)	229
TABLE 16.	Properties of the Word Orders in the DP in Spoken Colloquial Russian. .	231
TABLE 17.	Possible Focus Structures for Split Scrambling Constructions in Russian .	247

CHAPTER 7

TABLE 18.	Percentage of Russian 3-Member Sentence Types	256
TABLE 19.	Frame 2 Data: Mean Verb Reading Time (in msec) as a Function of Scrambling Type, for DP and PP Sentences with Categorically Unambiguous Frame 1	274
TABLE 20.	Frame 4 Data: Mean Noun/ Adverb Reading Time (in msec) as a Function of Scrambling Type and Categorical Ambiguity, for DP Sentences (left panel) and PP Sentences (right panel)	276
TABLE 21.	Mean Percentage Adjective Interpretation, as a Function of Fragment Length and Ambiguity	286
TABLE 22.	Percentage Noun Location in the Medium Unambiguous Fragments	288
TABLE 23.	Mean Percentage Adjective Interpretation, as a Function of Task Instruction and Ambiguity	289

APPENDICES

TABLE A.	Rated Accessibility of Meanings for NOM/ ACC in Experiment 1	299
TABLE B.	Rated Accessibility of Meanings for INSTR in Experiment 1	300
TABLE C.	Rated Accessibility of Meanings for DAT in Experiment 1	302
TABLE D.	%Adj Interpretations of Ambiguous N/ Adj Critical Element in Experiment 4	321
TABLE E.	%Adj Interpretations of Unambiguous N/ Adj Critical Element in Experiment 4	322

LIST OF ABBREVIATIONS

ACC	Accusative
CF	Constituent Focus
CL	Clitic
CS	Constituent stress
DAT	Dative
DO	Direct object
F	Focus
FBS	Focus-Background Structure
FEM	Feminine
FF	Functional Form
GEN	Genitive
HSPM	Human Sentence Processing Mechanism
INDIC	Indicative
INSTR	Instrumental
IO	Indirect object
IS	Information Structure
LC	Late Closure
LOC	Locative
MA	Minimal Attachment
MCP	Minimal Chain Principle
NEUT	Neuter
NOM	Nominative
PERF	Perfective
PG	Parasitic gap
PL	Plural
PREP	Prepositional
Q	Question particle
QM	Question marker
REFL	Reflexive
REL	Relative
SCO	Strong Crossover
SF	Sentential Focus
SG	Singular
SS	Sentential stress
SUBJ	Subject
SUBJU	Subjunctive
T	Topic
TCS	Topic-Comment Structure
TOP	Topic
VOC	Vocative
WCO	Weak Crossover

INTRODUCTION

1.1 Overview of Dissertation

This dissertation reports an investigation of scrambling constructions in Russian from two perspectives: from the point of view of syntactic theory and from the point of view of sentence processing. Despite a seemingly unrestricted freedom of word order in Russian, the claim of this dissertation is that current syntactic theory within the framework of Government-Binding theory (Chomsky, 1986) and its latest development, the Minimalist program (Chomsky, 1993, 1995) and the Garden-Path model of sentence processing (Frazier and Fodor, 1978; De Vincenzi, 1991; Fodor and Inoue, 1995; Frazier and Clifton, 1996) adequately account for all the word order facts. A project of interest to both linguistics and psycholinguistics is to try to factor apart their respective contributions to judgments of sentence acceptability. It can be asked which domain exhibits general principles which can subsume the facts observed. Ideally, we would study every construction in a language from both points of view in order to arrive at a well-grounded analysis of whatever constraints the construction is subject to. This is of particular interest in the case of Scrambling in Russian. While some of its restrictions (for example, island constraints) are of a familiar grammatical nature, Russian also exhibits Split Scrambling which obeys three restrictions, the Periphery Constraint, the One-Split-per-Clause Constraint, and the Preposition-First Constraint, and they could possibly be attributed to processing limitations. Both potential explanations will be examined here. By the end of the dissertation I conclude that these constraints can be explained as grammatical restrictions following from the Double-Movement analysis and Focus assignment in Russian split scrambling constructions.

Slavic languages and Russian in particular provide a valuable testing ground for both the universal theory of Scrambling and the theory of sentence processing. Investigation of the syntactic properties of XP-Scrambling in Russian is interesting because Russian phrase structure

differs typologically from that of configurational languages with Scrambling such as Japanese, Korean, German, Dutch, and other Germanic languages, Hindi, and Latin, and from non-configurational languages with Scrambling such as Warlpiri and other Australian Aboriginal languages. Russian has been argued to be a configurational but not verb-final language (King, 1993; Bailyn, 1995); rather, it has a canonical SVO word order. Its discourse-oriented flexibility of surface word order is taken as evidence of Scrambling that is much less heavily restricted than in many other scrambling languages. Scrambling accounts for as much as 17% of sentences in a Russian corpus study reported in Bailyn (1995). This contrasts with Japanese, for example, in which scrambled constructions represent less than 1% of all sentences (Yamashita, 1996). There seems to be reason to believe that in Russian, Scrambling, Wh-movement, Topicalization and Right Extraposition may be indistinguishable from each other, and could all be subsumed under the general heading of Focus-driven Scrambling. This situation is different from that in other scrambling languages where Wh-movement, Topicalization, and Scrambling have distinct properties (Müller and Sternefeld, 1993). Finally, Russian is one of the subset of the scrambling languages which exhibits Split Scrambling in which XPs can be broken up and their subparts moved to different locations in the sentence.

The study of word order variation cross-linguistically should contribute to a theory of the universal principles and parameters of language variation which govern Scrambling. A universal theory of Scrambling needs to address issues such as the following. Is surface word order variation derived via movement, or are different surface word orders base-generated? If movement is involved, then what choices does the grammar offer with respect to the phrase types that can scramble, the landing sites they can move to and direction of movement? These represent the parameter values that can be elected by individual languages. What type of movement is Scrambling in terms of the nature of its landing sites: Is it A'- or A-movement or does it involve both ('non-uniform movement')? Though the issue of landing sites has been the central one in research on the universal theory of Scrambling, recently it has become increasingly

important to find a derivational motivation for Scrambling. The Minimalist program, which has developed recently out of GB theory, requires every movement to be obligatory; otherwise it would violate the principle of economy. Is it possible to show that despite the apparently optional character of Scrambling, it is in fact necessitated by specific requirements?

From the typological point of view, a universal theory of Scrambling should address the question whether the presence of Scrambling in a language correlates with any other properties of that language. Is Scrambling an invariable characteristic of configurational languages which are verb- or head-final? Or is it exclusively associated with non-configurational languages (Hale, 1983; Austin and Bresnan, 1996)? The typological characteristics of languages which exhibit Scrambling are important for establishing whether there is a fundamental parametric distinction between non-configurational and configurational languages, or whether there is a continuum from fixed word order languages which do not allow Scrambling, like English, to free word order languages which exhibit maximum Scrambling.

The most common type of Scrambling is what I refer to here as *XP-*, or *phrasal, Scrambling*. It appears that in all languages that permit Scrambling, the scrambled elements can be maximal projections of one sort or another; most commonly, they are DPs and PPs. A central point of the dissertation is that while Russian does allow XP-Scrambling, it also allows DPs and PPs to be broken up by Scrambling; this is what I call *Split Scrambling*. With regard to the scope of Scrambling, it is most common for languages to permit movement to landing sites contained within the same clause. However, the possibility of moving a scrambled phrase outside of the clause in which it was base-generated, exists in some scrambling languages and implies an additional parameter of language variation: presence or absence of Long-Distance Scrambling. Presumably this is due to language variation with respect to the barriers for movement. Russian allows Long-Distance Scrambling only marginally, and I will not discuss it in this dissertation.

A word of caution is due at this point. It cannot be clear until an investigation is concluded whether the facts addressed constitute a genuinely homogeneous phenomenon. Thus

the constructions that are standardly referred to as Scrambling constructions might ultimately turn out to be a whole set of different phenomena. Equally, it is possible that some other types of movement, for example, Wh-movement and Topicalization, may ultimately be subsumed under the general phenomenon of Scrambling. However, for the sake of organizing the research program, we need a working definition of Scrambling that will serve as a preliminary attempt to delineate the phenomenon under investigation. XP-Scrambling is temporarily defined here as an operation which moves a maximal projection from its base position to one of three possible landing sites: IP-adjoined position, VP-adjoined position, and SPEC, F(ocus)P within the same clause.¹ Split Scrambling is defined as an operation which breaks up DPs and PPs and moves one or both of their subparts into different positions in the sentence. These are working definitions which may need to be refined as the theory evolves. Uncovering the true nature and derivational origin of these constructions is the goal of the endeavor. I will argue below that Split Scrambling is an operation involving two steps: first, XP-Scrambling of a phrase to SPEC, FP and then extracting a Y' out of it to a right FP-adjoined position

Note that I am presupposing in adopting these working definitions that Scrambling is a movement phenomenon. Earlier studies of XP-Scrambling have revealed that Scrambling obeys many of the syntactic constraints which traditionally have been observed to apply to movement phenomena, leading to the conclusion that a movement approach is likely to be a more fruitful way to investigate Scrambling than a base-generation approach. Base-generation approaches will not be discussed in this dissertation; references are given in Section 2.5, Chapter 2. Within the movement approach to XP-Scrambling, the nature of the landing site has been discussed extensively in studies of Japanese (Saito, 1985; 1992; Tada, 1995; Takahashi and Boškovic, 1995)), Korean (Lee, 1993), German (Frank et al., 1992; Bayer and Kornfilt, 1994), Dutch (Neelema, 1994),

¹ In fact, the movement analysis can be recast in terms of a Copy/Spellout operation (Chomsky, 1993; 1995). Since the Copy/Spellout analysis is still a working hypothesis whose details have not yet been completely worked out, it is not entirely clear how it may differ in the empirical consequences from a more traditional movement approach.

Hindi (Mahajan, 1990; 1994), Scandinavian languages (Vikner, 1994), and Latin (Ostafin, 1986). A series of syntactic tests has been developed to investigate the nature of the landing site for scrambled phrases. These include the licensing of parasitic gaps and the interaction of the Binding Theory with movement: Weak Crossover (WCO), Strong Crossover (SCO) or Condition C Reconstruction effect, and anaphor binding. The results of these tests have not been clear-cut, however, making it difficult to convincingly classify the landing site for Scrambling as an A'- or A-position. At the present moment, the most convincing approach appears to consider the landing site an A'-position, IP- or VP-adjoined; however, with VP-adjunction, short Scrambling of objects in a double-object construction is claimed to exhibit A-movement properties or even may require a base-generation analysis (Miyagawa, 1997).

Following the arguments for establishing landing sites for XP-Scrambling in Russian presented by King (1993), Bailyn (1995), and Kondrashova (1996), one of the claims of this dissertation is that XP-Scrambling in Russian exhibits the same mixed behavior with respect to the distinction between A' vs. A-position as has been observed in other scrambling languages. Application of the syntactic tests designed to clarify the type of landing site for scrambled phrases in Russian shows that it exhibits mixed properties with respect to movement of arguments in the double-object construction. Consequently, I propose to analyze XP-Scrambling in Russian as essentially A'-movement which, however, exhibits mixed properties which are by now familiar from other scrambling languages. While the A'-movement analysis of XP-Scrambling best explains the descriptive generalizations in (1) presented in this dissertation, certain parameter settings are needed to distinguish Russian from other scrambling languages:

- (1)
- a. Any XP can scramble (potentially including IP and VP);
 - b. Multiple XPs can scramble in a clause;
 - c. Scrambling can be bidirectional;
 - d. It is discourse-oriented.

A movement analysis of XP-Scrambling in Russian presupposes that there is an underlying structure and order of the Russian clause and that phrases are scrambled from their base-generated positions into IP- or VP-adjoined positions to derive various surface word orders. The two recent proposals argued for by King (1993) and Bailyn (1995) agree on an underlying structure of Russian in which the subject is generated in the SPEC, VP position, making it an SVO language. However, the canonical, that is, discourse-neutral, surface word order of Russian is claimed to be VSO by King but still SVO by Bailyn, (derived by movements of S and V before Spellout). Since the VSO analysis of the canonical word order of Russian has not proven to be superior to the traditional SVO analysis, I will assume here a more traditional SVO canonical word order for the Russian clause, from which all other surface word orders are derived via Scrambling.

Investigation of XP-Scrambling requires a comparison with other well-established instances of A'-movement such as Wh-movement and Topicalization and also Right Extrapolation. One of the claims of this dissertation is that XP-Scrambling, Wh-movement and Topicalization may be a unified phenomenon in Russian. Evidence comes from the parallel behavior of these three instances of movement. Wh-phrases can remain *in situ* or can move to a higher position in the clause in a way that is indistinguishable from IP-adjunction. Under normal conditions, no FP is projected in either scrambling or Wh-movement constructions. As far as Topicalization is concerned, preservation of morphological Case and a landing site located at the beginning of the clause make it also compatible with an XP-Scrambling analysis, in contrast with the Left-Dislocation construction in which the left-dislocated phrase must be analyzed as base-generated in this position.

In this dissertation it is assumed that XP-scrambled constructions are derived by moving a maximal projection of any type to an IP-adjoined (medium Scrambling) or to a VP-adjoined (short Scrambling) position. Besides short object Scrambling, Right Extrapolation of subjects (postverbal subjects) also uses VP-adjunction as the landing site. Alternatively, postverbal

subjects in Russian might be derived by XP-Scrambling of all the constituents out of VP. Junghanns and Zybatow (1995) refer to the latter possibility as the VP-Evacuation hypothesis (along the lines of Kayne's (1994) Antisymmetry theory which prohibits rightward movement). More convincing arguments in favor of one approach or the other are needed. For concreteness I will make the assumption that postverbal subjects are derived via XP-Scrambling of subjects which moves them to the right of VP. Thus, XP-Scrambling in Russian is taken to be bidirectional. This means that the parameter controlling the location of the landing site for Russian must be set accordingly. The following surface structures must be posited for Russian XP-scrambled constructions:

(2) a. Left IP-Adjunction (of Object)

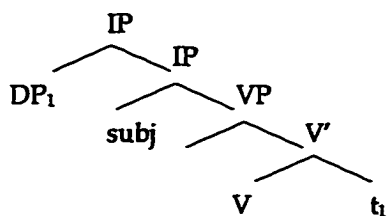

b. Right IP-Adjunction (of Object)

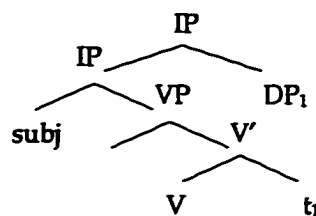

c. Left VP-Adjunction (of Object)

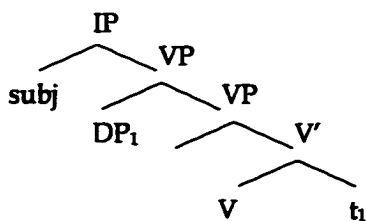

d. Right VP-Adjunction (of Subject)

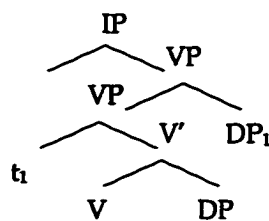

XP-Scrambling of several maximal projections will result in multiple adjunctions. The two following parameter settings are necessary for XP-Scrambling in Russian:

(3) (a) Landing Sites: VP, IP;

(b) Direction: leftward, rightward.

One of the generalizations which describes Russian XP-Scrambling (see (1) above) specifies it as discourse-oriented. Discourse conditions impose a particular Focus structure on a

sentence. Typically, a sentence can have one of two types of foci: default Sentential Focus or narrow Constituent Focus. Focusless sentences are prohibited. Focus structure of a sentence depends on its prosodic characteristics: the most deeply embedded constituent receives the main sentential stress by default, and the Focus Rule assigns sentential Focus to this constituent. According to the Focus Projection Rule, it can project up the syntactic tree resulting in a functionally ambiguous structure in which either (or both) VP and IP are in the domain of projecting Focus. Besides sentential Focus, a sentence can have a Constituent Focus which is licensed when the constituent receives a marked constituent stress different from the default sentential one.

Reinhart (1995) has suggested that XP-Scrambling and Focus interact: an object scrambles in Dutch in order to move out of the most embedded position and this allows sentential Focus to be assigned to some other constituent in the sentence, e.g., the verb. The scrambled phrase by virtue of its adjoined landing position creates a barrier for projecting Focus; thus, Dutch sentences with object Scrambling have a special Focus structure. Reinhart argued that XP-Scrambling and Focus can interact because there is an syntax-phonology interface, enriched PF, where both the full syntactic tree and relevant prosodic and segmental phonological features are present simultaneously at the same point in the derivation.

In this dissertation, it is proposed that Reinhart's Focus-driven analysis of object Scrambling in Dutch can be applied to XP-Scrambling in Russian. Discourse circumstances may require that a constituent which would receive sentential Focus by default not to be focused. There is only one way to de-focus such a constituent – move it. XP-Scrambling copies a constituent out of the domain of the sentential Focus, and this operation changes the Focus structure of the sentence. Thus, XP-Scrambling in Russian serves to split the tree for focus purposes since the IP- (or VP-)adjoined scrambled phrase cannot be included into the projecting Focus. I propose that this is triggered by a feature [-SS] (sentential stress) on the phrase which undergoes XP-Scrambling. This feature is present at enriched PF since it codes important

prosodic information which participates in building the Focus structure of the sentence. It is a strong feature; in virtue of being strong, it needs to be checked off overtly in the syntax. In this way, XP-Scrambling becomes obligatory. In addition, a different feature [+CS] (constituent stress) can be independently assigned to any constituent, allowing it to receive Constituent Focus. Since this operation is separate from XP-Scrambling, either scrambled or non-scrambled phrases can be assigned Constituent Focus.

Enriched PF provides an interface at which XP-Scrambling and prosody interact, and this obviates the necessity to postulate an additional abstract level of Functional Form. The four functional approaches to XP-Scrambling in Russian (King, 1993; Bailyn, 1995; Kondrashova, 1996; Junghanns and Zybatow, 1995) assume Functional Form (FF). The level of FF is claimed to host covert Scrambling (in addition to overt Scrambling in the syntax) in order to make all word orders in Russian obey, at that level, a general principle according to which given (Topic) should precede new information (Focus). In contrast, the proposed Focus-driven analysis of XP-Scrambling applies at the enriched PF level to account for Scrambling without postulating this additional abstract level. It also provides an explanation for the interaction between XP-Scrambling as a determinant of Focus and prosodic means of establishing Focus, and how this affects ambiguity related to Focus projection.

This dissertation is only one step in what I hope will eventually be a much more comprehensive study of surface word order variation in Russian. One goal is to provide a syntactic analysis of the two major types of scrambling constructions, XP-Scrambling and Split Scrambling, in order to establish how UG accounts for the Russian facts and to determine what the relevant parameters of cross-language variation may be. A syntactic analysis of Russian scrambling constructions is also a necessary preliminary step in providing an account of how these constructions are processed in sentence comprehension. Just as the theory of grammar has as its goal an account of Universal Grammar and parameters of language variation, the theory of sentence processing has as its goal the characterization of the universal parser, the Human

Sentence Processing Mechanism (HSPM). The theory of sentence processing has to address, among other questions, how movement constructions are processed in general, and how scrambling constructions are processed in particular. The experimental evidence reported in this dissertation concerning how scrambling constructions in Russian are processed can thus contribute to the general theory of sentence processing as well as laying down a foundation for further studies on how Russian is processed.

The Garden-Path model of sentence processing has been developed by Kimball (1973), Frazier and Fodor (1978), De Vincenzi (1991), Frazier and Clifton (1996) and many other works. It argues for incremental serial processing in which initial syntactic parsing is guided by universal principles of structure-building. Major principles of the Garden-Path theory are Minimal Attachment (MA), Late Closure (LC) (also known as Right Association), the Minimal Chain Principle (MCP), Construal (Frazier and Clifton, 1996), and Minimal Revision. These are viewed as falling out of the general architecture of HSPM which in turn is considered to be innate. It may even lack any parametric variation, though that is not fully agreed on. A Minimal Attachment analysis will be available earlier than a nonminimal one due to the fact that it requires access of a smaller number of phrase structure rules (or equivalent, in other linguistic frameworks). A Late Closure analysis permits earlier structuring of new input items, since it requires attachment of new items into the clause or phrase currently being processed if grammatically permissible. The MCP, which applies to the processing of sentences with filler-gap dependencies, states that a chain should not be postulated until it is necessary; but when necessary, postulation of a chain should not be delayed (De Vincenzi, 1991). That is, chain postulation is a last resort, and chains are terminated as soon as possible. Construal accounts for processing of phrases that do not participate in predicate – argument structure, such as adjuncts (Frazier and Clifton, 1996). The Minimal Revision principle makes revision a last resort, and when it is unavoidable the structure should be revised just sufficiently to restore well-formedness (Inoue, 1991; Frazier and Clifton, 1996; and papers in Ferreira and Fodor (in press)). Generalizing over these principles, the

Garden-Path model follows the strategy of Minimal Everything (Inoue and Fodor, 1995). That is, given two possible structures, one more complex than the other, the parser pursues the less complex one until there is evidence to the contrary. Cross-linguistic work on a variety of materials from languages as diverse as Italian, Spanish, Japanese show that MA and the MCP appear to be universal principles of structure-building.²

Scrambling constructions derived by Double-Movement constitute sentences with filler-gap dependencies of A'-type where the scrambled phrase leaves a trace in its D-Structure position. A substantial amount of sentence processing research has been carried out for sentences with Wh-movement (Fodor, 1978) and it has been found that filler-gap dependencies of the Wh-movement type can have a cost associated with processing of Wh-chains, as reflected by the MCP (Frazier, 1989; De Vincenzi, 1991; Stojanovic, 1997). However, very little is known about the processing of XP-scrambling constructions. Since scrambled surface word orders are derived from the base-generated underlying structure, it might be hypothesized that they will be processed in the same manner as familiar filler-gap dependencies of the Wh-movement type. Specifically, we ask: Is the MCP applicable to processing of XP-scrambling constructions? Is there any processing load associated with XP-Scrambling? Are Scrambling 'fillers' easy to recognize (Xie, 1997)? Are their associated 'gap' positions easy to identify on-line?

Experimental work dealing with the processing of Scrambling is still at a preliminary stage. Yamashita (1996) found no cost associated with the processing of scrambling constructions in Japanese and claimed that the parser ignores word order information and relies exclusively on overt Case markers. Bader's (1994) study of a sample of scrambling constructions in German also did not find convincing empirical evidence in favor of processing complexity of XP-Scrambling. One possible reason why these two studies may have found no complexity effect is that there are strong restrictions imposed on XP-Scrambling in both Japanese and German. Fewer restrictions

² There has been some recent debate concerning the universality of LC; see Cuetos, Mitchell, and Corley (1996) for discussion.

on XP-Scrambling may possibly contribute to a different pattern of processing of scrambling constructions in Russian.

Globally ambiguous sentences of Russian were used as experimental materials in a sentence processing study of XP-Scrambling. The goal of the study was to determine accessibility of each of the two possible meanings for these sentences, as evidence for which operations the parser finds easy and which difficult. On the basis of this, it can be established whether the Garden-Path theory of sentence processing can account for processing of Russian XP-scrambled constructions. Do proposed universal principles of structure-building, most relevantly, the MCP and Minimal Revision, apply in Russian processing? Do they suffice to account for the processing profile associated with XP-Scrambling or are other principles needed as well?

The globally ambiguous sentences that were tested were of three different types: they contained either a Nominative/Accusative (NOM/ACC) ambiguity, or a Dative (DAT) ambiguity, or an Instrumental (INSTR) ambiguity. They were selected to represent a variety of ambiguous constructions which are not found in English, in order to contribute some new facts to the many findings on syntactic ambiguity in English. The NOM/ACC ambiguity occurs in simple sentences where the Case markers on subject and object are morphologically ambiguous. This makes it possible not only to investigate the Scrambling Complexity Hypothesis, that is, whether there is a processing cost of Scrambling, but also to test an observation made for German by Bader and Meng (1996). They found that in sentences with Case ambiguity, the HSPM prefers structural Case over lexical Case; and of the structural Cases, it prefers NOM to ACC. The DAT ambiguity involves the syntactic identity of the position at which the dative phrase is attached in the tree, and crucially relies on the bidirectionality of Scrambling. Finally, the INSTR ambiguity involves an ambiguity between an argument and an adjunct, an ambiguity important for the Construal hypothesis (Frazier and Clifton, 1996).

Experiment 1 was an off-line questionnaire designed to test application of the MCP and Minimal Revision in processing of Russian XP-scrambled of these three types. Experiment 1

sought evidence of the accessibility of the two possible meanings for the globally ambiguous sentences, for each of the three ambiguity types, by asking subjects to rate how natural each possible meaning is. If it can be shown that subjects systematically favor unscrambled structures and avoid revisions, this would constitute *prima facie* evidence for the MCP and Minimal Revision.

Experiment 2 was an on-line reading study designed to investigate how ambiguous XP-scrambling constructions in Russian are processed by establishing the parser's preferred analysis in terms of answers to comprehension questions and reading times. The comprehension question data provided more information about whether the MCP and Minimal Revision are at work in processing of Russian XP-scrambling constructions. Easier accessibility of a particular meaning and a shift in patterns of accessibility as a function of word order can constitute an argument for or against these principles. The evidence from this experiment, as from Experiment 1, was positive. The reading time showed that reading times lengthened as a result of XP-Scrambling, which can be taken as evidence for a processing load associated with XP-Scrambling, that is, the Scrambling Complexity Hypothesis.

The results of the two experiments on XP-Scrambling show that Russian fits well with the Garden-Path theory; both the MCP and Minimal Revision apply in the standard way and no new principles are required. Russian also provides evidence for the processing complexity hypothesis: XP-Scrambling imposes an additional processing cost compared to unscrambled sentences, as reflected in lengthening of the reading times for scrambled sentences.

Split Scrambling which derives discontinuous DPs and PPs is found in two registers of Russian: the language of literature and folklore, and Colloquial spoken language. Discontinuous DPs and PPs in which modifiers of all kinds are separated from the N head by other constituents, are found in classical languages, such as Sanskrit, Ancient Greek, Latin, (Hall, 1995), and Old Church Slavonic, and in contemporary languages such as Modern Greek (Androutsopoulou, 1997), Polish (Siewierska, 1985), Serbo-Croatian (Franks and Progovac, 1994), and Australian

Aboriginal Languages (Austin and Bresnan, 1996). However, cross-linguistic research on Split Scrambling as an operation which produces discontinuous constituents has only just begun and is still at a preliminary stage of data description. The phenomenon is of considerable theoretical interest since it appears to violate locality requirements that are strictly observed in other languages.

Split Scrambling in Russian differs from XP-Scrambling in that it obeys a special set of restrictions. Three of these, which I call the Periphery Constraint, the One-Split-per-Clause Constraint, and the Preposition-First Constraint are the focus of Part II of this dissertation. Informally stated, the Periphery Constraint requires the subparts of the discontinuous constituent to appear on the right and left outermost edges of the clause. The One-Split-per-Clause Constraint prohibits more than one discontinuous constituent per clause. The Preposition-First Constraint prohibits any part of the prepositional complement to precede the preposition itself. Discontinuous DPs and PPs in Russian are different from discontinuous DPs and PPs in non-configurational languages like Warlpiri because overt morphological agreement between the subparts of a discontinuous constituent is always obligatory (though possibly ambiguous) in Russian but is not required in Warlpiri (Austin and Bresnan, 1996). Discontinuous DPs and PPs in Russian resemble those in Latin, Serbo-Croatian, Polish, and Modern Greek. However, there is a crucial difference: split DPs and PPs in Russian allow symmetrical patterns of split word orders; both Adj X N and N X Adj are possible. In contrast, Serbo-Croatian and Modern Greek exhibit an asymmetry: only the former pattern, Adj X N is allowed. Polish and Russian appear to have the Periphery Constraint while Latin, Modern Greek, and Serbo-Croatian do not. The One-Split-per-Clause Constraint is possibly operable in Polish but has not been discussed for other languages.

Syntactic analysis of Split Scrambling should be conducted as an indispensable part of the larger project which aims to investigate the universal theory of Scrambling. Thus, the investigation of Split Scrambling should raise the same issues as does the analysis of XP-Scrambling. Are split word orders derived via movement or are they base-generated? If the

movement analysis of Split Scrambling is adopted, as in this dissertation, which phrases can undergo Split Scrambling and what are their landing sites? Whether a particular language allows Split Scrambling may or may not be correlated with its other typological characteristics, which need to be investigated.

Existing attempts³ to provide an analysis for Split Scrambling in configurational languages like Latin, Serb-Croatian, and Modern Greek argue that Split Scrambling is a movement operation as evidenced by its sensitivity to syntactic constraints like Subjacency although parameterized (Ostafin, 1986) and strong islands (Androutsopoulou, 1997). In terms of how these discontinuous DPs and PPs are derived via movement, two approaches exist in the literature. One says simply that a discontinuous constituent is derived by XP-Scrambling which takes a phrase and extracts it out of a larger maximal projection to some landing site. The other approach proposes to derive Split Scrambling via a two-step movement in which an NP is extracted out of the DP (or PP), and the remnant with the trace inside subsequently undergoes movement (Scrambling or Topicalization). This analysis, referred to as the Double-Movement analysis, is argued for by Franks and Progovac (1994) for Serbo-Croatian and Androutsopoulou (1997) for Modern Greek.

A claim of this dissertation is that split scrambling constructions in Russian are derived via Double-Movement, but that it differs from the double-movement analysis proposed for other languages with Split Scrambling. The first step is XP-Scrambling, which moves a DP (PP) into SPEC, FP, then followed by Extraction which moves a Y' out of the scrambled phrase and right-adjoins it to FP, leaving the remnant of the DP (PP) in SPEC, FP. This contrasts with previous proposals in which a remnant is first created and then moved. The analysis proposed here is required in order to explain the descriptive characteristics of split scrambling constructions in

³ Papers in the Huck and Ojeda (1987) volume investigate the phenomenon of split constituents such as split VP in English. However, the analyses proposed by contributors to this volume for degree words and their complements, verb plus particle constructions, extraposition out of NP, PP, and relative clause, Right-Node Raising constructions, adverb placement, Stripping, comparatives, and gapping, do not seem to be relevant for the analysis of Russian discontinuous DPs and PPs.

Russian. Russian split scrambling constructions with a single adjectival modifier exhibit five properties identified in this dissertation (4):

- (4) (a) Discontinuity within the DP (and PP) involves phrases containing a head noun and just one modifying adjective (or possessive, etc.);
- (b) Long-Distance Split Scrambling is not allowed;
- (c) *The Periphery Constraint*: In the overwhelming majority of cases, when the constituents of an XP are split up into two parts, one part occurs on the left edge of the clause (sentence-initially), while the other is moved to the right edge (sentence-finally);
- (d) *The Preposition-First Constraint* (for discontinuous PPs only): Discontinuity within the PP can occur only if the prepositional object is modified by an adjective, and no part of the prepositional object may precede the preposition.
- (e) *The One-Split-per-Clause Constraint*: Only one split constituent is allowed per clause.

In addition, discontinuous PPs differ from discontinuous DPs with respect to which split word orders are permitted. Discontinuous DPs allow symmetrical split word orders, as shown in (5), while discontinuous PPs allow only two out of 6 possible word orders, as shown in (6):

- (5) a. Adj X N
b. N X Adj
- (6) a. P Adj X N
b. P N X Adj
c. *Adj X P N
d. *N X P Adj
e. *P Stranding

The Double Movement analysis argued for in this dissertation better explains the distributional facts in (5) and (6) than either the standard XP-Scrambling analysis proposed for Latin, or the Double-Movement analyses proposed for Serbo-Croatian and Modern Greek. Crucially, this analysis is needed in order to account for the Periphery Constraint and the symmetry in split DP word orders and the asymmetry for split PPs. It makes it possible to unify

symmetry in split DP word orders and the asymmetry for split PPs. It makes it possible to unify XP-Scrambling and Split Scrambling, as the former feeds the latter. This analysis specifies two parameter settings, in addition to the two parameter settings proposed for XP-Scrambling (see (2) above) necessary to account for Russian Split Scrambling (7):

- (7) (a) Remnant *in Situ*: Yes/No;
 (b) Category of Extracted Element: N', A'.

A special Constituent Focus structure required by the discourse circumstances for Split Scrambling is reflected in the presence of the functional projection F(ocus)P which is projected in the tree higher than IP. A strong feature [-SS] (-sentential stress) is. The first application of movement moves a DP (or PP) via XP-Scrambling into SPEC, FP. A weak feature [+CS] (+constituent stress) is assigned to a particular subpart of the discontinuous constituent, an adjective or a noun. In consequence of this, a N' (or A') is then extracted and adjoined to the right of FP.

It is assumed for the purposes of this dissertation that there can be only one FP per clause. I will also tentatively suggest that there is independent evidence for FP in Russian which comes from an analysis of *èto*-cleft sentences (King, 1993). In split scrambling constructions, F⁰ is empty but the SPEC position is used as the landing site for the scrambled DP (PP). The fact that this SPEC position is unique and that it is the highest in the tree makes it possible to provide a tentative grammatical explanation for the Periphery Constraint and the One-Split-per-Clause Constraint.

The interaction between movement which derives both XP- and Split Scrambling, and Focus structure reflected in prosodic characteristics of a sentence, is made possible because there is a point in the derivation where they occur simultaneously. Following Reinhart (1995), this point in derivation is taken to be enriched PF: the syntactic tree is augmented with certain segmental and prosodic features. It is the claim of this dissertation that both types of Scrambling

in Russian are driven by Focus requirements. XP-Scrambling removes a DP (or PP) from the domain of default sentential Focus, i.e., it is what I will call a tree-splitting operation, which separates a constituent from the main part of the tree to which Focus assignment applies. Split Scrambling separates the adjectival modifier and head noun from each other, making each available individually for Constituent Focus assignment at the peripheral positions of the clause.

The Double-Movement analysis of Split Scrambling driven by Focus requirements appears to provide a plausible explanation for the Periphery Constraint, the Preposition-First Constraint and possibly, for the One-Split-per-Clause Constraint. Since there can be only one FP per clause, with a unique SPEC position, only one phrase can scramble into the SPEC, FP position and feed Split Scrambling. This will explain the One-Split-per-Clause Constraint as long as SPEC, FP is the only source of X'-element moving rightward. FP is argued to be projected high in the tree, above the expanded IP. Thus, its SPEC position on the left and an adjoined position on its right will necessarily be the left and the right outermost positions in the clause, which would explain the Periphery Constraint. Thus, linguistic explanations of these constraints follow quite plausibly from reasonable assumptions.

However, it is still not inconceivable to hypothesize that these constraints, especially the One-Split-per-Clause Constraint, could instead have a processing explanation. No experimental work has been done before on the processing of Split Scrambling in any language, so it is not known to what extent the Garden-Path theory of sentence processing can account for how split scrambling constructions are processed, either in general or in Russian in particular. Assuming that movement results in a chain, it would be predicted by the Garden-Path theory that it is subject to the MCP. There are two chains to be established in split scrambling constructions, one due to XP-Scrambling and the other to the second application movement operation (i.e., X'-Extraction). It would be expected, therefore, that Split Scrambling incurs an additional processing cost relative to XP-Scrambling. It is the claim of this dissertation that, as for XP-Scrambling in Russian, the processing of Split Scrambling can be fully accounted for by the

Garden-Path model, in particular, the MCP. The extra complexity of Split Scrambling might be sufficient motivation for a limit of one split per clause, in view of the independent evidence that multiple dependencies per clause are stressful (Fodor, 1978).

Thus, we are faced with the interesting situation of two possible accounts of the same constraint, a linguistic account and a processing account. Unlike the case of multiple center embedding, it is not *necessary* to invoke a processing account. This may be a case where, under pressure from the parsing routines, a practical limitation has become 'grammaticalized'. The fact that the grammar permits only one FP projection per clause would reflect the fact that sentences with more than one such projection are unusable because they are too difficult to process. Along the same lines, it is possible to hypothesize a processing explanation for the Periphery Constraint. Processing filler-gap dependencies poses several tricky problems. First, how is the filler recognized as a filler? Second, how is a gap recognized since it is not phonologically signaled? Finally, how to assign the right fillers to the right gaps when a sentence contains more than one? The pairing of fillers and gaps is more stressful in split scrambling constructions than in XP-Scrambling, and this may interact with the work of recognizing fillers and gaps. If the grammar establishes unique (or almost unique) positions for fillers and gaps in split scrambling constructions, recognition of fillers and gaps could be greatly simplified. The Periphery Constraint achieves this. Furthermore, it singles out the two most salient positions in the sentence as the locations of the two fillers – the sentence-initial and the sentence-final positions.

Deciding whether a linguistic or a processing explanation for a phenomenon is correct is never easy. In the present case, it was anticipated that the experiments designed to test the validity of the Garden-Path model for Russian might at the same time shed some light on the origin of the constraints on Russian Scrambling, by perhaps revealing some powerful stresses in the parsing process which might indicate that the HSPM is pushed to the limits of its capacity by some aspects of Scrambling, particularly Split Scrambling. In fact, as will be shown, though Split

Scrambling did emerge as costly, the processing pressures apparently oppose the Periphery Constraint, leaving linguistic factors as the likeliest explanation in this case.

One type of split word order was chosen for the experimental materials used in Experiments 3 and 4, (P) Adj...N. There are reasons why (P) Adj...N is illuminating from a processing point of view. First, as the production study by Sirotinina (1964) shows, this is the most commonly occurring split word order in Russian. Second, when the adjective comes first and is followed by a verb, a noun is expected to occur later in the input string, so the parser can recognize the existence of the dependency on-line. By contrast, if the noun comes first, an adjective as an optional modifier does not have to occur at all, so the split scrambling dependency cannot be recognized as such until the adjective eventually appears.

A specific contrast was employed in the experimental items in order to estimate the cost of Split Scrambling relative to the cost of XP-Scrambling. Half of the items contained an initial element (following a preposition in half the cases) which is ambiguous between a noun and an adjective. These 'nominalized' adjectives are known in the traditional Russian grammar as *substantivirovannye*, i.e., 'substantivized' adjectives. An ambiguous item of this sort creates a temporary ambiguity between XP-Scrambling and Split Scrambling because on the Noun interpretation there is no evidence at that point that anything is missing from the fronted XP. The MCP implies that the parser assumes there is no split in this situation. So if an isolated adjective occurs at the end of the clause this is expected to result in a garden-path effect. Both contrasts, XP-Scrambling vs. Split Scrambling, and ambiguity vs. no ambiguity, were tested for both discontinuous DPs and discontinuous PPs.

The main prediction of the experiment was that Split Scrambling would be dispreferred: when possible, an initial adjective would be perceived as nominalized in order to avoid postulating a Split Scrambling chain. If the adjective cannot be construed as a noun, then it would be expected to be immediately followed by a noun; if this expectation is not borne out by the input string, there should be an immediate processing cost, detectable in an on-line self-paced

reading experiment as a lengthening of reading times. While the experimental results for split PPs confirmed this prediction, the outcome of the on-line study for split DPs was less clear-cut. However, when tested in an off-line questionnaire, both discontinuous DPs and PPs produced the predicted results.

The results of the experiments on Split Scrambling are consistent with the Scrambling Complexity Hypothesis: Split Scrambling is more difficult to process than XP-Scrambling, and is avoided whenever possible. The additional cost associated with the processing of Split Scrambling in the on-line experiment provides a first step in discovering processing limitations which may lie behind the One-Split-per-Clause Constraint. The off-line experiment did not produce results confirming the Periphery Constraint. Further research will be necessary to investigate more fully the psychological reality of the Periphery Constraint, but a plausible explanation for the data is offered by the MCP which opposes the Periphery Constraint and appears to be more powerful on-line.

1.2 Outline of Following Chapters

This dissertation is laid out in a parallel fashion. Part I deals with the syntactic and processing aspects of XP-Scrambling in Russian and Part II deals with the syntactic and processing characteristics of Split Scrambling in Russian.

Chapter 2 (*Syntactic Properties of XP-Scrambling*) presents a movement analysis of XP-Scrambling in Russian which creates an A'-chain by moving phrases into IP- and VP-adjoined positions on either side. It investigates the set of parameters defined by UG which control various aspects of Scrambling such as the landing sites. It follows the traditional evidence that the canonical word order in Russian is SVO. It compares the syntactic properties of Wh-movement, Topicalization, and XP-Scrambling in Russian. It argues that XP-Scrambling in

Russian possesses syntactic characteristics and obeys restrictions on movement proposed for other scrambling languages discussed in the literature.

Chapter 3 (*Discourse Properties of XP-Scrambling*) compares a Focus-driven analysis of XP-Scrambling for Dutch (Reinhart, 1995) and several discourse-function analyses of XP-Scrambling for Russian. It argues for the former one as most appropriate for Russian XP-scrambling constructions. When discourse conditions specify that a phrase should not be included in the domain of sentential Focus, a strong [-SS] feature is assigned to it. This feature triggers an overt movement operation, i.e., XP-Scrambling. Thus, the function of XP-Scrambling is to break up a syntactic tree in order to de-focus a particular phrase by removing it from the domain of default sentential Focus.

Chapter 4 (*Processing Properties of XP-Scrambling*) reports the results of two sentence processing experiments: an off-line questionnaire which gathered data on meaning accessibility of three types of globally ambiguous Russian sentences with XP-Scrambling, and an on-line reading study which gathered reading time data for whole sentences, and accuracy data for answers to comprehension questions. These experiments were designed to investigate two hypotheses. One is that Russian and specifically XP-scrambling constructions are processed according to the already known principles of the Garden-Path theory of sentence processing. The other is the Scrambling Complexity Hypothesis according to which there is a high processing load associated with XP-Scrambling. The experimental results are consistent with both hypotheses.

Chapter 5 (*Syntactic Properties of Split Scrambling*) argues for a Double Movement analysis of split scrambling constructions in Russian. This analysis, though similar in spirit to the ones proposed for Split Scrambling in other languages, is different in its implementation because it accounts for a set of specific restrictions that Split Scrambling obeys in Russian. The first step is XP-Scrambling of a DP (or PP) into SPEC, F(ocus)P, a functional projection. The second step consists of Extraction of a N' (A') out of the scrambled DP (or PP) and adjoining it to the right of FP. Uniqueness of FP and its highest position in the tree provide a plausible grammatical

explanation for the Periphery Constraint, and the One-Split-per-Clause Constraint on Split Scrambling.

Chapter 6 (*Discourse Properties of Split Scrambling*) analyzes split Scrambling constructions in Russian as having a marked Focus structure: one of the subparts of the discontinuous constituent, the Adjective or the Noun, carries a marked stress [+CS]. The first step of Double-Movement which derives Split Scrambling is triggered by a strong Focus-related feature [-SS] (as described for XP-Scrambling in Chapter 3). It makes the scrambled DP (or PP) in SPEC, FP inaccessible for default sentential Focus. A separate prosodic feature [+CS] assigns marked stress to one of the subparts of the discontinuous constituent resulting in the Constituent Focus structure characteristic of split scrambling constructions in Russian.

Chapter 7 (*Processing Properties of Split Scrambling*) reports the results of two sentence processing experiments: an on-line self-paced reading study which gathered data on reading times in a chunk-by-chunk presentation of sentences with Split Scrambling, and an off-line questionnaire which gathered data on sentence completion of fragments with Split Scrambling. The results of both experiments taken together are essentially consistent with the Garden-Path theory of sentence processing and provide evidence for the Scrambling Complexity Hypothesis. The Periphery Constraint was not confirmed in the sentence completion experiment, and it is suggested that this provides a tentative argument against a processing source for this constraint. The extra processing load which was found for split scrambling constructions compared with XP-Scrambling is compatible with the possibility that the One-Split-per-Clause Constraint is a processing constraint. Further research will be needed to distinguish between this and a purely linguistic motivation for this constraint.

PART 1: XP-SCRAMBLING: SYNTAX AND PROCESSING

Chapter 2: Syntactic Properties of XP-Scrambling

2.1	Introduction	25
2.2	Structure of the Russian Clause	27
2.2.1	VSO (King, 1993)	29
2.2.2	SVO (Bailyn, 1995)	30
2.3	Syntactic Movement in Russian	34
2.3.1	Wh-Movement	34
2.3.2	Topicalization, Cleft Construction with <i>èto</i> , and Left-Dislocation	37
2.3.3	Right Extraposition	40
2.4	Syntactic Properties of XP-Scrambling in Russian	46
2.4.1	Descriptive Characteristics of Surface Word Order Variation	46
2.4.2	Syntactic Properties of Clause-Internal XP-Scrambling in Russian	51
2.4.2.1	Anaphor Binding	52
2.4.2.2	WCO	54
2.4.2.3	Anaphor Preposing	57
2.4.2.4	Condition C Reconstruction Effects (Strong Crossover)	58
2.4.2.5	Parasitic Gaps	60
2.4.2.6	Summary	61
2.5	Syntactic Properties of XP-Scrambling Cross-Linguistically	63
2.5.1	XP-Scrambling as A'-Movement	64
2.5.2	XP-Scrambling as A-Movement	67
2.5.3	XP-Scrambling as Non-Uniform Movement	72
2.5.4	Summary	75
2.6	Summary of Chapter 2	77

2.1 Introduction

Russian is a language which exhibits a rich morphological system of case marking. Subjects in Russian usually appear in the Nominative (NOM) case and impose subject-verb agreement on the predicate. Direct objects usually appear in the Accusative (ACC) case and indirect objects in the Dative (DAT) case. Thus, grammatical relations are reflected by the case marking, and arguments can be freely ordered. In the examples (1), *mal'čik* 'the boy-NOM' is the subject, and *knigu* 'the book-ACC' is the direct object, regardless of the word order, because they are NOM and ACC, respectively:

- (1) a. Mal'čik čitaet knigu.
 boy-NOM is reading book-ACC
- b. Knigu čitaet mal'čik.
 book-ACC is reading boy-NOM
 'The boy is reading the book.'

All six combinations of the three words in the sentence are possible: SVO, SOV, OSV, OVS, VSO, VOS.

Although word order is free with respect to grammatical relations, it does reflect the organization of a sentence on a communicative level (Greenberg, 1987). The most often discussed factor in determining Russian word order is the so-called *Given/New* (or *Theme/Rheme*, or *Topic/Comment*) distinction (Yokoyama, 1982; Franks and House, 1982; Fowler, 1987). Example (1a) is a sentence about the boy (Theme), with the assertion (Rheme) that he is reading the book. (1b) is about the book (Theme), with the assertion (Rheme) that the boy is reading it. The Theme is the starting point of the utterance and is often known to the listener or can be determined from the surrounding context. The Rheme tells the listener something about the Theme, carries the main communicative load of the utterance, and contains new information. In neutral speech the Theme precedes the Rheme. The Theme/Rheme distinction plays a major role in explaining the

properties of Russian word order as a result of XP-Scrambling in recent theories of King (1993), Bailyn (1995), Kondrashova (1996), and Junghanns and Zybatow (1995) (see Section 3.3 below).

There are two main approaches to analyzing surface word order variation within the Government-Binding theory (Chomsky, 1986) and its recent developments (Chomsky, 1993; 1995). One is to assume that different surface word orders are base-generated (Bayer and Cornfilt, 1994; Haider, 1994; Neeleman, 1994; Takahashi and Bošković, 1995). The other approach generates all surface word orders in a language from a single underlying basic structure, by a movement operation referred to as *Scrambling*. I follow the latter approach and assume that there is an underlying structure of the Russian clause from which phrases are scrambled to derive the various surface word orders.¹ Presence of an underlying structure which exhibits hierarchical properties (such as subject-object asymmetries) is criterial for configurationality.

Hale (1983) was the first to propose a configurationality/non-configurationality distinction based on syntactic properties of Australian Aboriginal languages, in particular Warlpiri. Recently, Austin and Bresnan (1996) showed that Jiwarli and six other Australian languages also exhibit non-configurational properties such as “free” (pragmatically-determined) word order, syntactically discontinuous expressions, no VP constituent (for verb and NP object), split-ergative case marking, and null anaphora. Russian is traditionally thought of as another language with free word order and discontinuous DPs/PPs.² However, despite these superficial features in common with Australian non-configurational languages, it is possible to show that Russian is configurational. One purpose of this chapter is to show that if the configurational hypothesis is adopted for Russian, its canonical, that is, discourse-neutral surface word order is SVO (Section 2.2).

¹ See Bailyn (1995) for arguments which show that scrambling constructions in Russian obey general constraints on movement (such as island constraints).

² See Part II of this dissertation for a detailed discussion of discontinuous DPs/PPs in Russian.

In Section 2.3, three types of A'-Movement are examined: Wh-Movement, Topicalization, and Extraposition. It will be shown that in Russian, all these movements behave very much like XP-Scrambling, which makes it possible to hypothesize that they all can be considered under one broad heading of Scrambling. It is very important, therefore, to investigate in detail the syntactic characteristics of XP-Scrambling. I will argue that all instances of movement in Russian are, by current tests, indistinguishable from Scrambling. To establish the properties of XP-Scrambling, I apply a range of standard syntactic tests developed in the literature to identify A'- or A-properties (Saito, 1985; Frank et al., 1992; Takahashi, 1995): anaphor binding, WCO, anaphor preposing, Condition C reconstruction effects (SCO), and parasitic gaps. The outcomes of these tests, applied to XP-scrambling in Russian, are compatible with analyzing Scrambling in Russian as having predominantly A'-type landing sites.

XP-Scrambling in Russian will be shown to exhibit the following descriptive properties: any XP can undergo Scrambling; it can be bidirectional and multiple, and is discourse-oriented. These descriptive characteristics of XP-Scrambling can be as parameter settings within a universal theory of Scrambling. Russian-specific parameter settings include IP- and VP-adjunction (and also as will be shown in Chapter 5, substitution into SPEC, FP) as the landing sites for scrambled phrases, and both left and right direction for movement.

2.2 Structure of the Russian Clause

King (1993) and Bailyn (1995) present syntactic evidence in favor of the configurational properties of Russian. The arguments are based on the following facts: 1) coordination, 2) Genitive of negation, 3) distribution of negative markers, 4) head-to-head movement in yes-no *li* questions, and 5) subject-object and direct/indirect object asymmetries.

Coordination facts show that Russian has both IP (2a) and VP (2b) constituents:

- (2) a. Nekotorye deti [_r čitali_i [_{VP} t_i knigi] i [_r smotreli_i [_{VP} t_i fil'm].
 some children read books and watched movie
 'Some children were reading the books and watching the film.'

- b. Ja budu [v_{VP} pisať pis'ma] i [v_{VP} čitať knigi] ves' den'.
 I will write letters and read books all day
 'I will write letters and read books all day.' (King 1993: (4) and (6))

The direct object in Russian usually appears in ACC. But when it is in the scope of verbal negation, it may be marked with GEN, as shown in (3a); this is referred to as *the GEN of negation*. King shows that the domain of the GEN of negation is structural, and is the sister to V⁰. Subjects, as in (3b), in contrast, never undergo the GEN of negation indicating that they are structurally higher than the object, namely, in SPEC, VP:

- (3) a. Mal'čik ne vidit knigi.
 boy-NOM not see book-GEN
 'The boy does not see the book.'
- b. *Mal'čika ne vidit knigu.
 boy-GEN not see book-ACC
 'The boy does not see the book.' (King 1993: (11))

Finally, subject-object asymmetries found in Russian prove the existence of an independent VP constituent that includes objects of the verb but excludes the subject. These asymmetries are illustrated by binding and extraction (Bailyn, 1995).

The distinction between (4a) and (4b) shows that a subject can be the antecedent of an anaphor which is embedded within the object position but not vice versa:

- (4) a. Ivan_i ljubit svoju_i daču.
 Ivan-NOM likes self's country house-ACC
 'Ivan_i likes his_i country house.'
- b. *Svoji dom volnuet Ivana_i.
 self's house-NOM worries Ivan-ACC
 '*His_i house worries Ivan_i.'

There is a contrast in acceptability between extracting subjects (5a) and extracting objects (5b) of embedded clauses:

- (5) a. ?čto_i tebe xotelos' by, čtoby Ivan kupil t_i?
 what-ACC you-DAT want SUBJU that Ivan-NOM bought
 'What would you want Ivan to buy?'

- b. *kto_i tebe xotelos' by, čtoby t_i ušel?
 who-NOM you-DAT want SUBJU that left
 * 'Who would you want that left?'

(Bailyn 1995: (38))

Based on the syntactic properties illustrated in examples (1-5), we can consider the configurational nature of the Russian clause established with a separate configurational VP constituent and a subject that asymmetrically c-commands a VP-internal object.³

2.2.1 VSO (King, 1993)

King (1993) and Bailyn (1995), while agreeing on configurationality of Russian, propose different discourse-neutral structures. Contrary to common assumptions, King argues that Russian is a VSO language, not an SVO one. According to her theory, all movement out of the VP in Russian results in either topic or focus interpretation. In presentational sentences, where there are no discourse-motivated movements of the arguments, the verb precedes both the subject and the object, as shown in (6a). In the derivation of this example, schematically represented in (6b), the verb raises to Σ^0 , a functional projection higher than VP, thus resulting in the discourse-neutral position for the subject, which is after, and not before the verb:

- (6) a. Postroila koza izbušku v lesu.
 built goat-NOM hut-ACC in woods-PREP
 'The goat built a hut in the woods.'

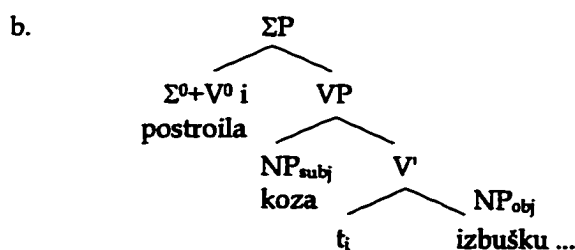

³ King and Bailyn disagree, however, on details of VP-internal structure. While King takes the standard approach that the direct object is a sister to V⁰, Bailyn argues on the basis of VP-internal asymmetries that it is the indirect object that is a sister to V⁰ while the direct object is in SPEC, VP. I will follow King's analysis.

Although the subject is base-generated in SPEC, VP resulting in the initial SVO word order, this D-Structure order does not occur in the surface in presentational sentences because the finite verb obligatorily raises to Σ^0 .

King argues that SPEC, ΣP is not a subject position in Russian but is reserved for contrastive focus, so the subject does not have a SPEC position available for it to raise to. That is why preverbal subjects are always interpreted as topics, since topicalization in Russian is analyzed by King as adjunction to ΣP . In (6) the entire sentence (or VP) is focused, and the subject follows the verb.

King's proposal that Russian discourse-neutral word order is VSO goes against the traditional view, which is based on the fact that in the overwhelming majority of utterances the subject precedes the verb. King claims that in those sentences, discourse conditions force the subject to be interpreted as Topic, requiring it to raise above the moved verb and to adjoin to ΣP resulting in the superficial SVO word order.

2.2.2 SVO (Bailyn, 1995)

Bailyn observes that King's (1993) theory of the VSO nature of Russian depends crucially on the obligatory raising of V^0 to I^0 . He argues against obligatory $V^0 \rightarrow I^0$ in Russian and proposes an alternative analysis of Short Verb Movement, which, in its turn, confirms the traditional view of the Russian clause as SVO.

If Russian were a VSO language, it should have syntactic properties similar to other well-studied VSO languages, such as Welsh. However, typologically Russian significantly differs from Welsh. First, question particles whose position in the clause is fixed do not occur in a standard VSO language. In contrast, the Russian clitic *li* occurs in second position in embedded clauses, as shown in (7):

- (7) Ja xoču uznať, na rabote li Ivan.
 I-NOM want to know at work Q Ivan-NOM
 'I want to know whether Ivan is at work.'

Second, Russian does not have any sentence-initial question particles, a feature common to VSO languages. Third, VSO languages usually have post-nominal adjectives while in Russian the neutral position for adjectives is pre-nominal. Moreover, Bailyn shows that Russian word order does not correspond to Welsh word order. In basic transitive sentences, sentences with the double-object construction, and with auxiliaries, Welsh word order is different from Russian. All these arguments suggest that Russian typologically does not pattern together with VSO languages.

On the other hand, it does not pattern with SVO languages of the French type where there is obligatory verb raising to I^0 . Instead, Bailyn argues for the Short Verb Movement (SVM) hypothesis according to which the verb in Russian only raises to a functional projection which is beneath the IP and immediately dominates the VP. Bailyn refers to this projection as Pred(icate)P, as shown in (8). He claims that the SVM provides a better explanation for across-the-board extraction, θ -role assignment in double-object constructions, adverb placement, coordination and negation, and pronoun fronting in Russian.⁴

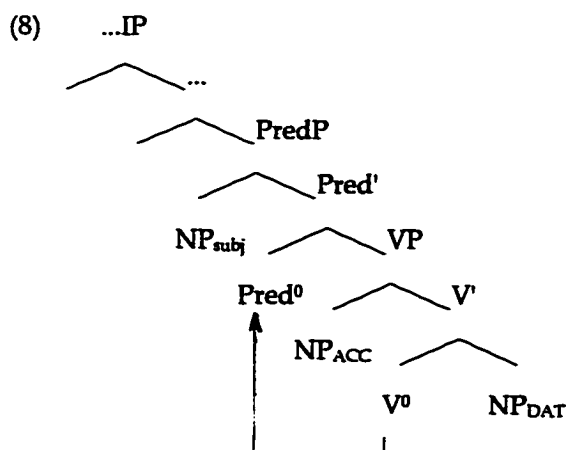

⁴ See Bailyn's (1995) Chapter 2 for detailed argumentation for the Short Verb Movement Hypothesis and justification of PredP as well as arguments against $V^0 \rightarrow I^0$ raising.

In (8), the subject originates in SPEC, PredP while the direct object is in SPEC, VP resulting in the initial D-Structure SOV word order. The verb obligatorily raises to Pred⁰ creating the discourse-neutral SVO order.

Consider how the two proposals about the discourse-neutral structure of the Russian clause, VSO (King, 1993) versus SVO (Bailyn, 1995), account for the derivation of simple transitive sentences like (1) *Mal'čik čitaet knigu* 'The boy is reading the book':

(9) a. King (1993)

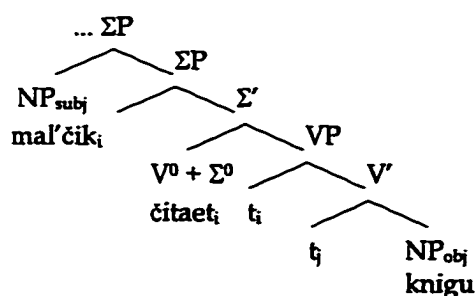

b. Bailyn (1995)

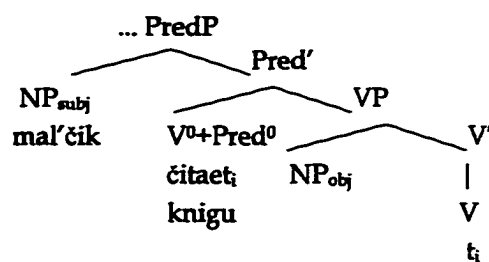

boy-NOM is reading book-ACC
'The boy is reading the book.'

Bailyn supplements his syntactic arguments for the discourse-neutral SVO analysis of Russian with experimental evidence⁵, including two acquisition studies and one sentence processing experiment. In his acquisition experiments, Russian children ages 3.8 – 5.5 exhibited sensitivity to the distinction between discourse-neutral word order (SVO) and discourse sensitive non-SVO word orders, which the children had greater difficulty with. In a repetition task, children correctly repeated only 40% of discourse-marked sentences. In 60% of the cases, they repeated them differently: either they reverted to the SVO word order or they provided appropriate discourse continuation for such sentences. In contrast, 83% of the SVO sentences were repeated correctly. Finally, Bailyn reports an experiment for adult speakers conducted by Holden and Krupp (1987), where the informants were presented with a questionnaire which

⁵ Bailyn also offers some frequency counts and sample statistical research on word order variation in Russian.

included all six possible orders in basic transitive SVO sentences. Sentences were presented in a neutral and six discourse-marked contexts. The subjects were asked to rank these sentences when read with neutral intonation. The results show that SVO was the preferred word order in all sentences with lexically filled subjects and objects, in both neutral and marked contexts. In Chapter 4 of this dissertation, I present the results of two different sentence processing experiments, also conducted with Russian adult speakers. The experiments were designed in such a way as to answer some basic questions about the parsing strategies that native Russian speakers employ while processing scrambled constructions. I argue that the results of these experiments are compatible with SVO as the discourse-neutral word order of the Russian clause.

For the remainder of this dissertation I will assume the canonical SVO hypothesis. However, I do not need to adhere to any particular structure of the IP projection.⁶ It is enough for our purposes to assume an expanded IP projection, which allows for several functional projections between the IP and VP. The underlying structure of the Russian clause assumed in the rest of this dissertation is represented in (10), where X^0 heads Tense projection and Y^0 Focus projection:

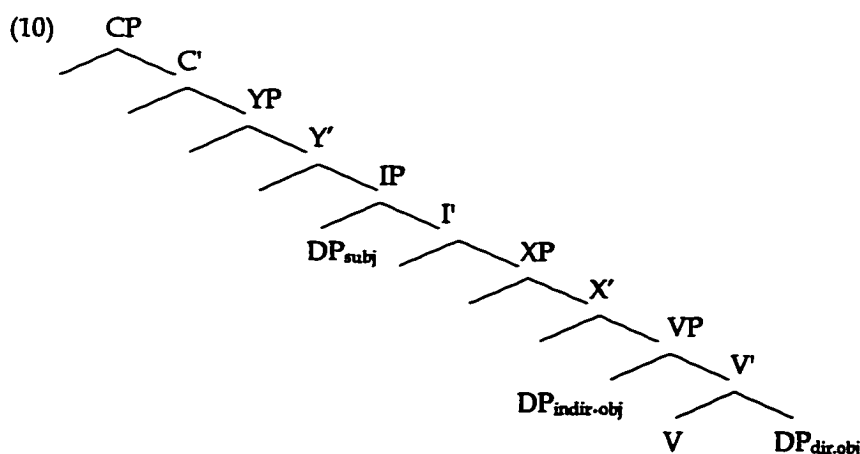

⁶ Bailyn's theory is quite recent and has not been subject yet to thorough linguistic scrutiny from other linguists working in Russian syntax. For example, it is not clear how Bailyn's theory is compatible with the standard Agro/Agrs structure.

2.3 Syntactic Movement in Russian

Having decided on a fixed hierarchical underlying structure of the Russian clause (10), and its canonical surface realization, we now have to explain the numerous possible surface word orders, generating them via XP-Scrambling. It is important to look at the various word orders which result from XP-Scrambling in the context of a more general theory of Russian syntactic constructions. In what follows I will compare properties of Wh-Movement, Topicalization, Extraposition, and XP-Scrambling and show that at S-Structure they behave very much alike and that a more detailed analysis would allow all of them to be subsumed under the heading of XP-Scrambling.

2.3.1 Wh-Movement

Simple matrix clause Wh-movement in Russian is illustrated in paradigm (11):

- (11) a. Wh-phrase in situ:
 Ivan uvidel kogo?
 Ivan-NOM saw who-ACC
 'Who did Ivan see?'
- b. Standard Wh-phrase raising:
 Kogo_i uvidel Ivan t_i?
 Who-ACC saw Ivan-NOM
 'Who did Ivan see?'
- c. Multiple Wh-phrase fronting:⁷
 Kogda_j kogo_i Ivan videl t_i t_j?
 When who-ACC Ivan-NOM saw
 'Who did Ivan see when?'
- d. Wh-phrase in scrambled positions:
 Ivan kogo_i videl t_i?
 Ivan-NOM who-ACC saw
 'Who did Ivan see?'

⁷ It is not clear whether multiple Wh-fronting in Russian exhibits Superiority effects (see King, 1993 for discussion.)

- d. *Kogo_i ty думаеś', čto Ivan ljubit t_i?
 who-ACC you think that-INDIC Ivan-NOM loves
 'Who_i do you think that Ivan loves t_i?'

However, Long Distance extraction in Russian is possible out of *čtoby*-argument clauses (in contrast to *čto*, *čtoby* is an overt subjunctive complementizer), though only for object extraction because of the *that*-trace effect (13a) vs. (13b), out of infinitival clauses, as in (13c), and out of finite clauses without overt complementizers (13d (cf. 12d)):

- (13) a. ?Kogo_i ty xočeś', čtoby Ivan poljubil t_i?
 who-ACC you want that-SUBJU Ivan-NOM loved
 'Who_i do you want Ivan to love t_i?'
 b. *Kto_i ty xočeś', čtoby t_i poljubil Ivana?
 who-NOM you want that-SUBJU loved Ivan-ACC
 'Who do you want to love Ivan?'
 c. Komu_i ty xočeś' pomogať t_i?
 who-DAT you want to help
 'Who do you want to help?'
 d. Kogo_i ty думаеś', Ivan ljubit t_i?
 who-ACC you think Ivan-NOM loves
 'Who_i do you think Ivan loves t_i?'

It will be shown in Section 2.4. that XP-Scrambling in Russian obeys the same restrictions in exactly the same manner: a phrase cannot be extracted out of NP-islands, out of adjunct clauses, out of Wh-islands, or out of an embedded clause introduced by the overt indicative complementizer *čto*. In parallel to examples (13), a phrase can be scrambled out of *čtoby*-argument clauses, out of infinitival clauses, and out of finite clauses without complementizers.

To summarize, Wh-words in Russian can be *in situ*, in scrambled IP- and VP-adjoined positions, and in SPEC, CP at S-Structure. Long-Distance Wh-movement obeys all the standard syntactic constraints on movement. It creates an operator-variable relation at LF. It is (at least superficially) optional, and it can be multiple. Given that a Wh-phrase is typically a focus, and that Russian has (superficially) optional focus movement to adjoin to VP or IP (see below) or into the Spec of a functional projection above IP, it seems quite possible that when Wh-phrase moves in Russian it does so *qua focus*. To further support this identification, it would be necessary to

compare the evidence for a hypothesized CP landing site for Wh-movement with the evidence for a FP landing site for focus movement, but I will not undertake it here.

2.3.2 Topicalization, Cleft Construction with *eto*, and Left-Dislocation

It is not clear whether Russian has a syntactic rule of Topicalization in the standard sense of the word. Russian does not have a special topic marker or particle as do Korean and Japanese.¹⁰ Also, Russian constructions which might be thought of as counterparts to Topicalization examples in Germanic languages, exhibit properties different from those in Germanic languages.

Müller and Sternefeld (1993) argued that Topicalization in Germanic languages has the following properties (14):

- (14)
- (a) it can take place only once in a clause;
 - (b) it induces the V2 phenomenon;
 - (c) it is not clause-bounded;
 - (d) it blocks clause-bounded Wh-movement;
 - (e) in embedded clauses, it is possible only in special contexts;
 - (f) VP- and DP-subparts cannot be topicalized.

Based on this set of properties, Müller and Sternefeld conclude that Topicalization in Germanic languages, although an A'-movement, differs from Wh-movement. They suggest that it is neither movement to SPEC, CP (like Wh-movement) nor IP-adjunction (like XP-Scrambling). Topics move into the SPEC position of a special functional projection T(topic)P, and thus the Germanic clause structure includes the following segment - [_{CP} SPEC C [_{TOP}P SPEC Top ...]].

Russian constructions with movement that can be argued to be counterparts of Topicalization in Germanic languages are not restricted the way Germanic ones are. There can be

¹⁰ See Lee (1993) for discussion of Topicalization and Left-Dislocation in Korean; and Saito (1985) for discussion of Topicalization in Japanese.

more than one moved phrase in a clause, as shown in (15a), this movement does not block Wh-Movement, as in (15b), and it freely occurs in embedded clauses (15c):

- (15) a. Maše₁ sobaku₂ Ivan podaril t₁ t₂.
 Masha-DAT dog-ACC Ivan-NOM gave as a present
 'It was to Masha that Ivan gave a dog.'
- b. Sobaku₂ komu₁ Ivan podaril t₁ t₂?
 dog-ACC who-DAT Ivan-NOM gave as a present
 'To whom did Ivan give a dog?'
- c. Ja znaju, što Maše₁ sobaku₂ Ivan podaril t₁ t₂.
 I know that Masha-DAT dog-ACC Ivan-NOM gave as a present
 'I know that to Masha Ivan gave a dog.'

As far as the other restrictions on Topicalization in Germanic are concerned: Russian is not a V2 language; clause-boundedness of different instances of movement is imposed by a constraint related to the type of complementizer; and Russian exhibits robust Split Scrambling which produces discontinuous DPs and PPs.

The examples in (15) are quite different from two other constructions found in Russian, the cleft construction with *èto* (16a) and a left-dislocation construction (16b):

- (16) a. èto školu_i ja ljublju t_i.
 this-NEUT school- ACC I-NOM like
 'It is the school that I like.'
- b. škola_i kakoj ty ee_i pomniš'?
 school-NOM which-INSTR you-NOM it-ACC recall
 'The school, what do you recall of it?'

The most striking difference between (16a) and (16b) is the Case marking discrepancy. The noun that immediately follows *èto* in (16a) is always in the Case which is dependent on the verb in the clause. In (16b) the word *škola* 'school-NOM' is in NOM and is obligatorily supported by the resumptive pronoun *ee* 'it-ACC'. Neither of these two constructions can be iterative. The Left-Dislocation construction is strictly a matrix clause phenomenon, while the cleft construction is possible in both matrix and embedded clauses. King (1993)¹¹ and Bailyn (1995) argue that for the Left-Dislocation construction, there is no movement involved, it is base-generated.

¹¹ King (1993) refers to the Left-Dislocation construction in (16b) as the *external topic* construction.

King (1993) refers to (16a) as the *èto*-Cleft construction in Russian. The purpose of this construction is to focus the clefted element. An entire set of different constituents can appear in the position immediately following the word *èto*, any [+N] argument or adjunct can move to this position including modified DPs, conjoined phrases, and negated constituents. The Russian *èto*-Cleft construction differs from English clefts in the following properties: 1) relative pronouns never appear in this construction; 2) there is no copular verb after the word *èto*, even in the tenses where the copula is normally obligatory, and 3) it can appear in *Wh*-questions. On the basis of these differences and Case-marking properties King argues for a monoclausal analysis of the Russian *èto* Cleft construction, in contrast to the biclausal analysis of English clefts. King assumes the structure in (17):

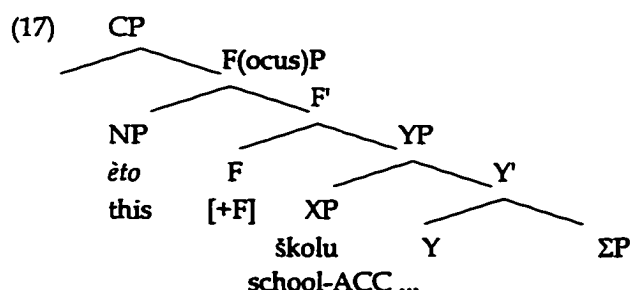

The cleft pronoun *èto* is in the SPEC of a functional projection F(ocus)P. The head of this projection is null and only hosts a focus feature [+F]. The focused constituent *školu* 'school-ACC' in (16a) is moved into SPEC, YP whose head is also null. The YP projection takes a Σ P (Σ P equals IP in the standard notation) complement to which topics adjoin.¹²

It is obvious from the discussion of the properties of the examples in (16) that they are quite different from those of (15). However, nothing distinguishes the examples in (15) from cases of standard XP-Scrambling. If we call instances of movement in (16) Topicalization in the standard sense, then the only difference between *Wh*-movement and Topicalization in Russian is the fact that the former creates an operator-variable relation and its landing site can be the SPEC

¹²King observes that the two null heads are never filled in any other constructions and leaves the precise analysis of these monoclausal *èto* clefts in Russian for future research.

position of CP while the latter results in IP-adjunction. Note that these are the same characteristics that distinguish Wh-movement from XP-Scrambling. Topicalization as it is defined for Germanic languages with its special properties as in (14), including the restrictions of being single and clause-bounded, inducing the V2 phenomenon and blocking Wh-movement, is not found in Russian. The most natural conclusion is that Russian does not have a separate syntactic rule of Topicalization, but both Topicalization and Wh-movement in Russian are arguably instances of broadly defined XP-Scrambling.

2.3.3. Right Extraposition

There is one more phenomenon in Russian grammar which hypothetically can be considered a special type of movement. Broadly, it is subsumed under the standard notion of Right Extraposition, although in the case of Russian, it is exemplified primarily by postverbal subjects. King (1993), Bailyn (1995), Junghanns and Zybatow (1995) all argue in favor of a Right Extraposition analysis of postverbal subjects in Russian. Kondrashova (1996) follows an analysis in the spirit of Kayne's (1994) antisymmetry thesis according to which the subject does not get extraposed but everything else in the clause moves to the left of it.

Whether there is rightward movement in the syntax on a par with leftward movement, has been a long-standing debate in GB theory. Thus, sentences like (18) (from Kayne (1994))

(18) Something t_i just happened [that you should know about]_i.

have traditionally been analyzed in terms of rightward movement of the relative clause, i.e., Extraposition. However, Kayne in his *Antisymmetry of Syntax* (1994) proposes a highly restrictive universal theory of a uniform underlying clause structure according to which all right-adjunctions are prohibited. This is a direct consequence of the central tenet of his proposal, the Linear Correspondence Axiom. Therefore, he argues that a rightward movement analysis of relative clause "extraposition" is not correct. Instead he reanalyzes the "extraposed" relative clause as "stranded" by leftward movement of the head of the relative clause:

(18') Something_i just happened [_{t_i} that you should know about].

Kayne argues that the Stranding analysis can account not only for relative clause extraposition, but for all other kinds of movements previously considered rightward movements, such as Heavy NP-Shift, PP-extraposition, right dislocations, comparative constructions and others.

Ordoñez (1994) following Kayne's proposal argues for a comparable analysis of postverbal subjects in Spanish:

- (19) a. Ayer resolvió_i [_{VP} Juan [_{VP} _{t_i} el problema]].
 yesterday solved John the problem
- b. Ayer resolvió_i el problema_j [_{VP} Juan [_{VP} _{t_i} _{t_j}]].
 yesterday solved the problem John
 'John solved the problem yesterday.'

The VSO order in (19a) is derived by leftward movement of the verb *resolvió* 'solved' past the subject that remains in its base-generated position, the SPEC of VP. The VOS order in (19b) is derived by moving the complement *el problema* 'the problem' past the subject, but after the verb. The landing site for the verb is a head of a functional projection higher than the VP, but lower than the CP. The landing site for the complement is the SPEC position of yet another functional projection, which immediately precedes the VP. Ordoñez refers to this analysis as *the Complement-Preposing hypothesis* which he contrasts to the *Free Inversion hypothesis* (Cinque, 1982) (19'b):

- (19') b. Ayer resolvió_i pro_k [_{VP} [_{VP} _{t_i} el problema] Juan_k].

In the Free Inversion hypothesis, the right-adjoined subject *Juan* 'John' c-commands the complement in both (19a-b). In Ordoñez's Complement-Preposing hypothesis, in (19b), it is the complement that c-commands the subject, while in the underlying structure (19a) the subject c-commands the complement. Only the Complement-Preposing hypothesis predicts syntactic asymmetries between the subject and the complement. Such asymmetries are indeed found in Spanish with respect to pronominal binding, quantifier scope, superiority effects, DAT clitic doubling, as well as focus assignment to the subject in (19b) but not in (19a).

Which of the two competing analyses for postverbal subjects better explains the Russian data: Right Extraposition argued for by King (1993), Bailyn (1995), Junghanns and Zybatow (1995), or Complement-Preposing along the lines of Kayne (1994) and Ordoñez (1994)? I will now show that the subject-complement asymmetries in Russian sentences with postverbal subjects are not as clear cut as they are in Spanish, and do not distinguish between the two possibilities. In the following chapters, I will adopt the Right Extraposition analysis of postverbal subjects in Russian and assume that Right Extraposition is a subcase of XP-Scrambling which proceeds to the right. The XP-Scrambling analysis of postverbal subjects better explains empirical facts (see Junghanns and Zybatow, 1995 for details) and is supported by experimental results found in sentence processing studies of XP-Scrambling in Russian (see Chapter 4).

First, pronominal binding is not allowed in either the V S Compl order, as in (20a), or the V Compl S order, as in (20b):

- (20) a. *Pokazal každogo gostja_i ego_i sosed Ivanu.
 showed each guest-ACC his neighbor-NOM Ivan-DAT
- b. *Pokazal ego_i sosed každogo gostja_i Ivanu.
 showed his neighbor-NOM each guest-ACC Ivan-DAT
 'His neighbor showed Ivan each guest.'

Russian does not exhibit Superiority effects for two Wh-words *in situ*, as shown in (21) :

- (21) a. Čto prines kto komu?
 what-ACC brought who-NOM who-DAT
- b. Čto prines komu kto?
 what-ACC brought who-DAT who-NOM
 'Who brought what to whom?'

With respect to scope ambiguity, in contrast to Spanish, Russian sentences with a combination of universal and existential quantifiers appear only to allow a single interpretation in both the V S Compl and V Compl S orders, as illustrated in (22), with quantifier order at LF matching the surface order:

- (22) a. Izučajut dva studenta každyj jazyk
 study two students-NOM each language-ACC (∃y∀x)

- b. Izučajut každyj jazyk dva studenta
 study each language-ACC two students-NOM ($\forall x\exists y$)
 'Two students are studying each language.'

Finally, the Focus interpretation of sentences with postverbal subjects appears to be ambiguous between default sentential focus and narrow focus, because the right-edge position in the Russian clause allows both, depending on the prosody (23) (see Chapter 3 for discussion). (The focused phrase is underlined, the syllable that carries sentential stress [+SS] is capitalized, the syllable that carries stress associated with Constituent Focus [+CS] is in bold):

- (23) a. Segodnja prigotovit zavtrak [MArio]
 today will prepare breakfast Mario[+SS]
 'Mario will prepare breakfast today.'
- b. Segodnja prigotovit zavtrak [MArio]
 today will prepare breakfast Mario[+CS]
 'It is Mario who will prepare breakfast today.'

We can conclude from the different properties exhibited by Spanish and Russian postverbal subjects that while Spanish postverbal subjects must be derived by moving the verb and the complement across them, this analysis is not necessarily the right one for Russian.

Junghanns and Zybatow (1995) offer an additional theoretical argument against the Verb-Complement-Preposing hypothesis which they refer to as *the VP-Evacuation hypothesis*. When the sentence contains more lexical material than just subject, verb, and object, as is the case with a VP-modifying adverbial, some unconventional movement will have to be assumed. The adverb *otoropjax* 'hurriedly' in (24) will have to move out of the VP as well, in order to derive the surface word order, which will force an analysis in which the verb raises all the way to C⁰, a process usually not found in Russian declarative clauses:

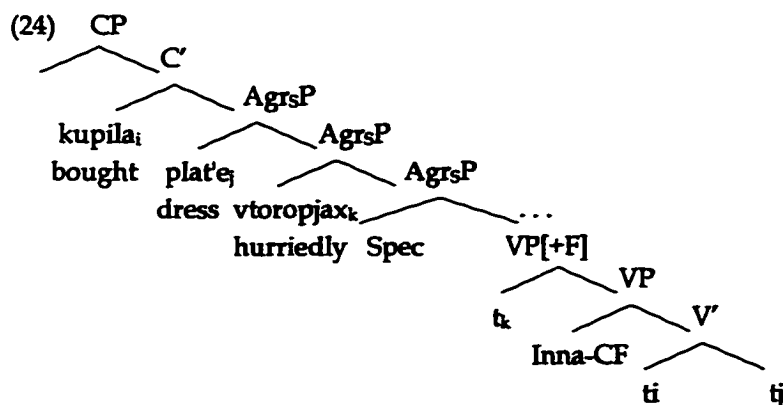

'It was Inna who hurriedly bought the dress.'

I now present an argument in favor of the Right Extraposition analysis and against VP-Evacuation. From the focus point of view, sentences like (24) may be ambiguous. They may be pronounced with the neutral default intonation which gradually falls until it reaches the stressed syllable of the last word in a sentence. This is the case in (23a). Alternatively, they may be pronounced with the intonation rising until the last word but one, then there is a pause, and the intonation falls sharply on the last word. This is the case in (23b) in which the final NP is interpreted as a Constituent Focus, and in this case, contrastive as well. Reinhart (1995) in her adaptation of Cinque's theory of focus argues that certain types of movement are motivated by PF considerations which are defined by their interaction with the focus structure of the sentence. If Russian sentences like (23) can be ambiguous between the two focus structures, we may hypothesize that it has two different possible representations. One has sentential focus, is derived by keeping the subject *in situ* and moving everything else out of the VP. This would correspond to (23a). The other one, associated with the Constituent Focus interpretation, as in (23b), has the subject right-adjoined to VP. The Right Extraposition structure for (23) will look as (23')¹³:

¹³ King assumes that the verb raises to the head of the functional projection ΣP in her version of (25). Bailyn argues that the verb only undergoes Short Verb Movement to the head of PredP, and Junghanns and Zybatow assume that the verb stays *in situ* in (25).

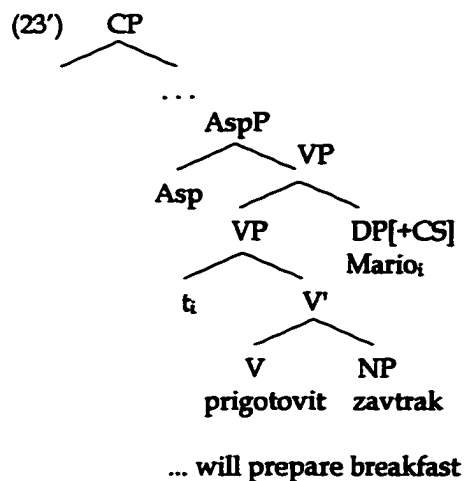

The alternative structure derived via the VP-Evacuation analysis is shown in (25):

(25) VP-Evacuation analysis for (23)

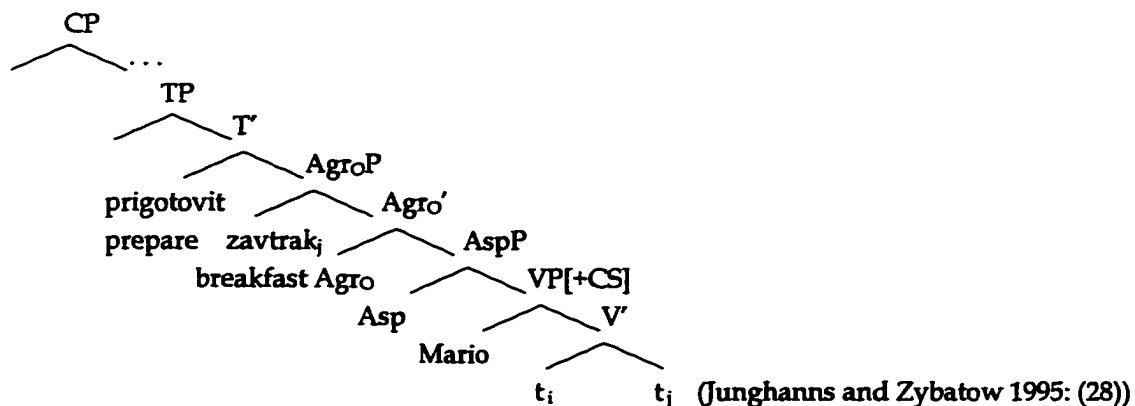

I will return to the issue of Focus assignment in Chapter 3.

In summary: it has been shown in this section that Topicalization, Wh-movement, Right Extraposition, and XP-Scrambling, which constitute different movement processes in Germanic languages, behave alike in Russian. Although such processes involve XPs with different featural properties, e.g., Wh-phrases for Wh-movement, and subject for Right Extraposition, they share the same general syntactic profile. Therefore, all these processes in Russian can tentatively be subsumed under one heading of XP-Scrambling, broadly understood.

2.4 Syntactic Properties of XP-Scrambling in Russian

2.4.1 Descriptive Characteristics of Surface Word Order Variation

On the descriptive level, it appears that Russian allows for unrestricted clause-internal XP-Scrambling. Any constituent type can be scrambled: CP (26a), IP (26b), DP (see (15) above), PP (26c), AdvP (26d), DP subject (26e), small clause (26f):

- (26) a. [_{CP} Čto_i on provalilsja na ekzamene]_i, Ivan uznal t_i sliskom pozdno.
 that he flunked at the exam Ivan found out too late
 'That he flunked the exam Ivan found out too late.'
- b. Mne [_{IP} pis'ma_i napisat' t_i]_i ne predstavilos' slučaja t_i.
 I-DAT letter-GEN to write not presented occasion-GEN
 'There was not an occasion for me to write a letter.'
- c. [_{PP} Na ekzamine]_i Ivan provalilsja t_i.
 On exam-PREP Ivan-NOM flunked
 'Ivan flunked the exam.'
- d. Včera_i Ivan provalilsja na ekzamine t_i.
 yesterday Ivan-NOM flunked on exam-PREP
 'Ivan flunked the exam yesterday.'
- e. [_{IP} t_i sdal ekzamen]_i Ivan_i uspešno.
 passed exam-ACC Ivan-NOM successfully
 'Ivan passed the exam successfully.'
- f. [_{SC} P'janym]_j my Ivana_i nikogda ne videli t_i t_j.
 drunk we-NOM Ivan-ACC never not saw
 'We have never seen Ivan drunk.'

The examples in (26) show only a sample of possible word orders in such sentences. In fact, there is much more variety. For example, in (26e-f) the adverb can scramble together with the VP, or the subject can be extraposed beyond the AdvP.

Compared to clause-internal XP-Scrambling in other languages, clause-internal XP-Scrambling in Russian exhibits more freedom. First, Russian allows XP-Scrambling of constituents not allowed in other scrambling languages. In German, VP, V-plus-particles, resultative predicates, idioms and their subparts cannot be scrambled. In Dutch, non-verbal predicates cannot be scrambled. In Japanese, VPs and subjects are immune to XP-Scrambling.

None of these restrictions hold for Russian since secondary predicates (including resultative and non-verbal ones) (26f), subjects (26e) and idioms (27a) and their subparts (27b) can scramble freely:

- (27) a. Ivan [_{NP} pritčej vo jazycex]_i stal t_i so svoim skandal'nym povedeniem.
Ivan talk-INSTR among tongues became with his scandalous behavior
- b. Pritčeji Ivan stal [_{NP} t_i vo jazycex] so svoim skandal'nym povedeniem.
talk-INSTR Ivan-NOM became among tongues with his scandalous behavior
'Ivan has become the talk of the town because of his scandalous behavior.'

Second, as Haider (1994) claims, German does not allow rightward XP-Scrambling. Rightward XP-Scrambling in Korean is so heavily restricted that Lee (1993) does not include it at all in her analysis. In contrast, I argued in Section 2.3.3 that in Russian, Right Extraposition of postverbal subjects is indistinguishable from XP-Scrambling and thus, the directionality of XP-Scrambling (26e) does not seem to be restricted in this respect.

Third, in German, Wh-words and focused elements cannot be scrambled. As has been shown above (Section 2.3.1), Russian Wh-movement is indistinguishable from XP-Scrambling in the sense since it appears that any XP-Scrambling landing site can serve as a landing site for Wh-words (see (11) above). XP-Scrambling of focused constituents is also allowed in Russian; though they lose their status as sententially focused elements, as shown in (28a), they become narrow focused ones, as in (28b) (sometimes but not necessarily contrastive):

- (28) a. Ivan provalilsja [na ekZAmine] včera.
Ivan-NOM flunked on exam-SF yesterday
'Ivan flunked the exam yesterday.'
- b. [_{FP} Na ekZAmine]_i Ivan provalilsja t_i včera.
On exam-NF Ivan-NOM flunked yesterday
'It was the exam that Ivan flunked yesterday.'

As in all known scrambling languages, more than one XP can be scrambled in Russian clause-internally. The order of scrambled constituents does not seem to affect acceptability.

The tempting conclusion is that clause-internal XP-Scrambling in Russian is unrestricted. However, when presented with different surface word orders for the same underlying sentence,

even in a zero context, native Russian speakers prefer some orders over others. This means that preferences with respect to XP-Scrambling do exist. We can distinguish three possible situations: (a) A particular word order is always possible, even when the context is zero, as in (29a); (b) a particular word order is impossible irrespective of the context, as in (29b), and (c) a particular word order is possible in a certain context only, as in (29c):

- (29) a. Nevnimatel'noe otnošenie administracii k rabočim poroždaet.
 inattentive attitude-NOM administration-GEN to workers causes
 tekučest' kadrov.
 instability-ACC manpower-GEN.
- b. *[K rabočim]₁ [tekučest' kadrov]₂ t₃ poroždaet
 to workers instability-ACC manpower-GEN causes
 [nevnimatel'noe otnošenie t₁ administracii]₃ t₂.
 inattentive attitude-NOM administration-GEN
 'Inattentive attitude of the administration to the workers causes instability of
 manpower.'
- c. A: - Na ètom zavode skoro nikogo ne ostanetsja – vse uxodjat!
 At this factory soon no one NEG will stay everybody is leaving
 'Soon there will be nobody left at this factory, everybody is leaving.'
- B: - [Tekučest' kadrov]₂ t₃ poroždaet t₂ [k raBOčim]₁
 instability-ACC manpower-GEN causes to workers-F
 [nevnimatel'noe otnošenie t₁ administracii]₃.
 inattentive attitude-NOM administration-GEN
 'It is inattentive attitude of the administration to the workers
 that causes instability of manpower.'

It is plausible that the difference between a fully acceptable word order (29a) and an unacceptable word order (29b) could be described by means of grammatical constraints. For instance, (29b) may be ruled out as extraction out of a complex DP. However, the difference between (29a), and one acceptable only under certain circumstances (29c), cannot be strictly ascribed to grammatical constraints. (Note: I am taking the relation between sentences and discourse context to lie outside of the grammar per se.)

In traditional prescriptive Russian grammar (Gol'cova and Jankelevič, 1974; *Praktičeskaja stilistika russkogo literaturnogo jazyka* 'Practical Stylistics of Literary Russian', 1970), word order variations, (i.e., XP-Scrambling) are deemed acceptable as long as they do not change the

grammatical relations, and therefore do not affect the semantic content of a sentence. What this amounts to is that stylistic rules do not allow XP-Scrambling to produce a word order that is the underlying order for a sentence with a different meaning. Five such cases in which XP-Scrambling would create unacceptable ambiguity are distinguished by Goľcova and Jankeleviĉ, as shown (30)-(34)¹⁴:

(30) Both the subject and the direct object have the same superficial case markings, that is, the NOM case morphologically coincides with the ACC:

- a. Avtobus obognal trolleybus.
 bus-NOM/ACC passed trolleybus-NOM/ACC
- b. Trolleybus obognal avtobus
 trolleybus-NOM/ACC passed bus-NOM/ACC
 'The bus passed the trolleybus.' or 'The trolleybus passed the bus.'

(31) A combination of a noun and a prenominal modifying adjective which agrees with it

(31a) is an NP, but a noun plus adjective is a sentence when the adjective is postnominal

(31b):

- a. Tixaja noĉ'
 quiet night
 'a quiet night'
- b. Noĉ' tixaja.
 night quiet
 'The night is quiet.'

(32) Two NPs form a sentence, the second NP being a predicate nominal. With the NPs in the opposite order, their grammatical roles are reversed:

- a. Moj brat – xokkeist.
 my brother hockey player
 'My brother is a hockey player.'
- b. Xokkeist – moj brat.
 hockey player my brother
 'The hockey player is my brother.'

¹⁴ There is an additional case where Scrambling affects interpretability. It occurs when the GEN case of a noun morphologically coincides with its ACC case (i), and looks like movement of the NP complement outside its complex DP:

- (i) a. On vstretil druga₁ otca [t_i]
 he-NOM met friend-ACC/GEN father-ACC/GEN
 'He met his father's friend.'
- b. On vstretil otca₁ druga [t_i]
 he-NOM met father-ACC/GEN friend-ACC
 'He met his friend's father.'

(33) A combination of a noun and a quantitative quantifier: a quantifier plus a noun means a precise amount (33a) while a noun plus quantifier means an approximate amount (33b):

- | | | | |
|----|---|----|---|
| a. | pjať karandašej
five pencils-GEN
'five pencils' | b. | karandašej pjať
pencils-GEN five
'about five pencils' |
|----|---|----|---|

(34) A modifying adjective separated from the head noun by a predicate that allows secondary predication becomes an adjunct predicate:

- | | | | |
|----|--|----|--|
| a. | Boľ'noj otec vernulsja.
sick father came home
'The sick father came home.' | b. | Otec vernulsja boľ'noj.
father came home sick
'The father came home sick.' |
|----|--|----|--|

Native speakers can interpret (30)¹⁵ in both ways (though they have a preference) but they do not judge the (a) examples in (31)-(34) as having the (b) reading too. This ambiguity is testament to the fact that XP-Scrambling is permitted here. Both SVO and OVS are allowed in Russian (despite prescriptivist recommendations), even when morphological case-marking is neutralized so that it results in ambiguity.¹⁶ Thus, there is no need for the syntax to limit Scrambling wherever a plausible stylistic constraint such as Ambiguity Avoidance would rule it out. The syntax is not responsible for limiting Scrambling in cases which are unacceptable only in some discourse context. The conclusion is that XP-Scrambling is very free in Russian, subject only to fundamental constraints on movement such as, for example, Subjacency.

The facts about descriptive properties of XP-Scrambling as movement, which is responsible for creating different surface word orders in Russian, can be summarized in the following set of generalizations (35):

¹⁵ Sentences like (30) constitute the first type of the three types of globally ambiguous Russian sentences that I used for the sentence processing study described in Chapter 4. I will return to these facts later, in Chapter 4.

¹⁶ Konieczny, Scheepers, & Hemforth (1994) discuss a similar NOM/ACC ambiguity in German and show that in sentences like (i), there is a strong preference to interpret an ambiguous NP in the *vorfeld*-position as the NOM subject:

(i)	Die hungrige Füchsin the hungry she-fox-NOM/ACC	bemerkte die fette Henne. noticed the fat chicken-NOM/ACC
-----	--	--

(35) **Generalization 1: Any XP can scramble in Russian.**

Generalization 2: XP-Scrambling can be multiple.

Generalization 3: XP-Scrambling is bidirectional.

Generalization 4: XP-Scrambling is discourse-oriented.

Generalization 1 states that clause-internal XP-Scrambling in Russian is much freer than in other scrambling languages with respect to what constituents can be affected by XP-Scrambling (cf. (26) above). Generalization 2 is illustrated in (15) above; however, general questions about the status of multiple XP-scrambling constructions in terms of acceptability and about the relative order in which the scrambled phrases appear on the surface require a separate investigation. XP-Scrambling although mostly leftward can be rightward, as is the case with postverbal subjects (cf. (26e) above). Finally, surface scrambled word orders are licensed under different discourse conditions (cf. (29) above). These descriptive generalizations serve as a basis for discussing the formal syntactic properties of XP-Scrambling in Russian, which represent consequences of the language-specific parameter settings within the universal theory of Scrambling.

We now turn to the syntactic tests which formally characterize XP-Scrambling in Russian. To the best of my knowledge, these tests have not been applied to Russian before this.

2.4.2 Syntactic Properties of Clause-Internal XP-Scrambling in Russian

In this section, I apply the criteria developed by Takahashi (lecture notes, CUNY 1995) following Saito (1985, 1992) and others (see references in Section 2.5) to identify the landing site of Scrambling in Russian as either an A- or an A'-position. This set of syntactic tests includes the following: anaphor binding, Weak Crossover, anaphor preposing, and the Binding Theory Condition C reconstruction effect. The results of these tests adapted for Japanese by Takahashi are summarized in Table 1. The mutual inconsistency of the Binding Theory Condition C reconstruction effect with anaphor binding and WCO remedy forced Takahashi to reject the

movement analysis of XP-Scrambling in Japanese and propose a base-generation theory (see Takahashi and Bošković, 1995).

Table 1. Tests for Syntactic Characteristics of Landing Site for XP-Scrambling in Japanese (Takahashi, 1995)

TYPE OF SCRAMBLING	ANAPHOR BINDING	WCO REMEDY	ANAPHOR BINDING WITH PREPOSING	CONDITION C RECONSTRUCTION
CLAUSE-INTERNAL	can be A-Movement	can be A-Movement	can be A'-Movement	cannot be A-Movement
LONG DISTANCE	cannot be A-Movement	cannot be A-Movement	can be A'-Movement	cannot be A-Movement

In the following sections I will apply these tests to Russian materials and will include an extra test to see if XP-Scrambling in Russian licenses parasitic gaps. This kind of organization of facts is just what linguistic theory should aim for. Unfortunately, the data for Russian presented below (as well as for Korean, German and other scrambling languages, see Section 2.5) are not as tidy as in analysis of Japanese (see Bošković and Takahashi, 1995) and require more detailed investigation than the one undertaken in this dissertation.

2.4.2.1 Anaphor Binding

Anaphor binding facts are used to show A-properties of XP-Scrambling. Mahajan (1990) and Saito (1985) have shown for Hindi and Japanese, respectively, that XP-Scrambling can rescue Condition A violations, such as (36a), by providing antecedents for anaphors, as in (36b). This is a property associated with A-movement.

- (36) a. *[otagai_i-no sensei] -ga [John to Mary]_i-o sikatta.
 each other teachers-NOM John and Mary -ACC scolded
- b. [John to Mary]_i-o [otagai-no sensei] -ga t_i sikatta.
 John and Mary -ACC each other teachers-NOM scolded
 'Each other's teachers scolded John and Mary.'

Note that in English, anaphor binding facts do not distinguish between A'- and A-Movement, as shown in (37):

- (37) a. [those pictures of himself_i]_j seem to John_i [t_j to be nice].
 b. [which pictures of himself_i]_j does John_i like t_j?
 (cf. Which pictures of John does he like?)

Example (37a) is an instance of A-movement and the anaphor embedded within the moved phrase can be bound. On the other hand, (37b) is Wh-movement, and again binding takes place. In both examples, the moved complex DP_j behaves as if it were put back into its D-structure position where the anaphor is properly bound by its antecedent. We can see that A-Movement and A'-Movement behave the same with respect to anaphor binding in English.

In Russian, anaphors are ungrammatical in subject position and examples directly parallel to sentences like (36) are impossible. However, we can test anaphor binding with indirect and direct objects in sentences with Short Scrambling. In (38), the indirect object *Petrovym* 'the Petrovs-DAT' binds the anaphoric direct object *drug drugu* 'each other-ACC', and in (39), the objects are reversed:

- (38) a. */?Ivan predstavil Petrovym₁ drug drugu₁. UNSCRAMBLED
 Ivan introduced the Petrovs-DAT each other-ACC
 b. *Ivan predstavil [drug drugu]₁ Petrovym₁ t₁. SCRAMBLED
 Ivan introduced each other-ACC the Petrovs-DAT
 'Ivan introduced each other to the Petrovs.'
- (39) a. Ivan predstavil drug drugu₁ Petrovyx₁. UNSCRAMBLED
 Ivan introduced each other-DAT the Petrovs-ACC
 b. Ivan predstavil [Petrovyx]₁ drug drugu₁ t₁. SCRAMBLED
 Ivan introduced the Petrovs-ACC each other-DAT
 'Ivan introduced the Petrovs to each other.'

It is standardly assumed that in the underlying structure for other scrambling languages, the indirect object precedes the direct object. If the same underlying order is assumed for Russian, then (38a) and (39a) are unscrambled D-structures. The ungrammatical (39b) is not rescued by XP-Scrambling. Its ungrammaticality can be attributed independently to felicity reasons as well

as the Principle A violation: the antecedent *Petrovym* ‘the Petrovs-DAT’ does not c-command the reciprocal *drug druga* ‘each other-ACC’. Example (39a) is grammatical (and stays that way after XP-Scrambling has applied to it, as in (39b)) so the rescue test cannot be applied here. We can conclude that the anaphor binding data in Russian are compatible with either an A’- or an A-type analysis for Short Scrambling.

2.4.2.2. Weak Crossover

The paradigm for WCO in English is used to distinguish between A-Movement which remedies WCO violations (40a, b) and A’-Movement which preserves WCO violations (41a, b):

- (40) a. *It seems to his_i mother that every boy_i is intelligent.
 b. Every boy_i seems to his_i mother [t_i to be intelligent].
- (41) a. *His_i mother likes every boy_i.
 b. *Which boy_i does his_i mother like t_i?

King (1993) argues that there is no WCO phenomenon in Russian comparable to that in English. She gives (42), with a reflexive, as a translation of (41b):

- (42) *Kakogo_i mal’čika ljubit svoja_i mama t_i?
 which boy-ACC loves self’s mother-NOM
 *‘Which boy_i does his_i mother like?’

In English, (43a) without a quantifier – variable relation contrasts with (41a), but (43b) is no better than (42) in Russian:

- (43) a. His_i mother loves Ivan_i.
 b. *Svoja_i mama ljubit Ivana_i.
 Self’s mother-NOM loves Ivan-ACC
 ‘His_i mother loves Ivan_i.’

The use of reflexives like *voj* ‘self’ is allowed in subjects only with arbitrary reference. Since (43b) is ruled out for independent reasons, its variable – binding versions such as (42) or the Russian equivalent (41a) cannot be used as a test of WCO.

In order to render the same interpretation as the English example (43a), it is necessary to use a possessive pronoun *ego* ‘his’ since possessive pronouns in Russian can have reflexive and

non-reflexive interpretation. If the possessive pronoun is used, the contrast between the English examples (40) and (41) holds for Russian, as shown in (44) and (45):

- (44) a. *Ego_i mama predstavila gostjam každygo mal'čika_i.
 his mother-NOM introduced guests-DAT every boy-ACC
 *'His_i mother introduced to the guests every boy_i.'
- b. [Každyj mal'čik]_i byl predstavlen gostjam t_i ego_i mamoj.
 Every boy-NOM was introduced guests-DAT his mother-INSTR
 'Every boy_i was introduced to the guests by his_i mother.'
- (45) a. *Ego_i mama ljubit každygo mal'čika_i.
 his mother loves every boy
 *'His mother loves every boy.'
- b. *[Kakogo mal'čika]_i ljubit t_i ego_i mama?
 which boy loves his mother
 *'Which boy does his mother love?'

In (45a), the quantified expression in the direct object position serves as a binder, while the possessive pronoun embedded in the subject is the bindee. When the quantified expression moves past the pronoun in (45b), the standard configuration for WCO is obtained, and the sentence is ruled out in contrast to (44b).

Let us consider how WCO effects interact with XP-Scrambling. Frank et al. (1992) analyzed the whole range of possibilities with respect to the way binding facts interact with XP-Scrambling in double-object constructions in German and Korean. When the paradigm of binding possibilities with the double-object construction suggested by Frank et al. is applied to Russian it produces mixed results very similar to the results found for Korean and German sentences.

The interaction of binding facts (for both anaphors and bound pronouns) with XP-Scrambling shows that while some instances of clause-internal XP-Scrambling in Russian, can be of A-movement type, as illustrated by example (46), others, such as (47) are of A'-movement type. Thus, just as Takahashi suggested for Japanese (see Table 1 above), XP-Scrambling in Russian can have properties associated with A-movement. Note that this analysis is consistent with Tada's

non-uniform approach to XP-Scrambling. In (46) and (47) the object is above the subject, for which the judgments differ. XP-Scrambling of object (direct or indirect) below the subject is A-Movement, while XP-Scrambling of object (direct or indirect) above the subject but within the same clause can exhibit both A'- and A-movement properties. This distinction possibly corresponds to different landing sites for XP-Scrambling of objects: VP-adjunction for object scrambled below the subject but above the verb; IP-adjunction (and SPEC, FP; see Chapter 5 for discussion) for objects scrambled above the subject.¹⁷

(46) Quantified expression (Indirect Object) binds possessive pronoun in Subject:

- a. *Ego_i sose_d pokazal ka_zdomu gostju_i kartinu. D-STRUCTURE
his neighbor-NOM showed every guest-DAT painting-ACC
- b. *Ego_i sose_d [ka_zdomu gostju_i] pokazal t₁ kartinu. VP-ADJUNCTION
his neighbor-NOM every guest-DAT showed picture
- c. [Ka_zdomu gostju_i]₁ ego_i sose_d pokazal t₁ kartinu. IP-ADJUNCTION
every guest-DAT his neighbor-NOM showed painting-ACC
'His neighbor showed every guest the painting.'

Example (46a) is a D-Structure, with no Scrambling involved. It is ungrammatical because the bindee, the pronoun, is not c-commanded by the binder, the quantified expression. In (47b), Middle XP-Scrambling of the quantified object over the pronoun embedded in the other DP changes an otherwise ungrammatical sentence into a grammatical one, in parallel with the A-movement example (44). If reconstruction were obligatory in such sentences, they would have stayed ungrammatical even after XP-Scrambling produced a proper c-commanding configuration at S-Structure. However, this is not the case with the examples in (47). The reconstruction is not obligatory. This is a property associated with A-movement.

(47) Quantified expression (Subject) binds possessive pronoun in Indirect Object:

- a. *Ka_zdyj gost'_i pokazal ego_i sose_du kartinu. D-STRUCTURE
Every guest-NOM showed his neighbor-DAT painting-ACC
- b. *Ka_zdyj gost'_i [ego_i sose_du]₁ pokazal t₁ kartinu. VP-ADJUNCTION
Every guest-NOM his neighbor-DAT showed painting-ACC

¹⁷ Miyagawa (1997) argues that object scrambling below the subject in the double-object construction in Japanese is not a movement but a base-generation phenomenon. I will leave this issue for future research.

- c. * $[\text{Ego}_i \text{ sosedu}]_1$ $\text{každyj gost}'_i$ $\text{pokazal } t_i$ kartinu. IP-ADJUNCTION
 his neighbor-DAT every guest-NOM showed painting-ACC
 'Every guest showed the painting to his neighbor.'

The examples in (47) show properties different from those of the examples in (46). The ungrammaticality of (47b) stems from the fact that the possessive pronoun *ego* 'his-DAT' within the indirect object which is scrambled to the left VP-adjoined position can only have a non-reflexive interpretation. As a non-reflexive pronoun, it obeys Principle B and cannot be bound by the quantified expression (for coreference, an overt reflexive *svoemu* 'self-DAT' is required.) An ungrammatical D-Structure in (47a) remains ungrammatical after XP-Scrambling to either vP- or IP-adjoined position has applied, as in (47b,c) respectively, which is presumably due to obligatory reconstruction of the scrambled quantified expression into its D-Structure position, in parallel to A'-movement illustrated in (45). Note that both instances of XP-Scrambling, to a VP-adjoined position and to an IP-adjoined position, behave exactly alike with respect to their binding properties. In short, the interaction of binding facts (for both anaphors and bound pronouns) with XP-Scrambling suggests that Russian clause-internal XP-Scrambling is of mixed A'/A-type.

2.4.2.3 Anaphor Preposing

In Japanese, an anaphor can be preposed to an A'-position, as shown in (48), similar to standard topicalized constructions (cf. (49)):

- (48) a. $\text{John}_i\text{-ga}$ $\text{zibunzisin}_i\text{-o}$ hiansita.
 John -NOM himself-ACC criticized
 b. $[\text{Zibunzisin}_i\text{-o}]_1$ $\text{John}_i\text{-ga}$ t_i hiansita.
 himself-ACC John -NOM criticized
 'John criticized himself.'

In English, anaphors in topicalized constructions exhibit the same A'-properties:

- (49) a. Himself_1 , John_1 likes t_1 .
 b. * Himself_1 seems to John_1 [t_1 to be sick].

(49b) is ruled out as a Condition C violation (and as a Condition A violation at the same time), because as subject, the anaphor *himself* raises into SPEC, IP, an A-position from which it would be forced to bind *John*; the sentence is ungrammatical with or without reconstruction. In (49a), the anaphor is in an IP-adjoined position, and it does not bind *John* from there which indicates possible reconstruction.

Comparable examples are found in Russian as well:

- (50) a. Ivan₁ sebja₁ uvažajet t₁.
Ivan-NOM self-ACC respects
- b. Sebja₁ Ivan₁ uvažajet t₁.
self-ACC Ivan-NOM respects
'Ivan respects himself.'

Therefore, anaphor preposing in Russian exhibits A'-properties in constructions with clause-internal XP-Scrambling.

2.4.2.4 Condition C Reconstruction Effects (Strong Crossover)

Strong Crossover effects are standardly interpreted as violations of Principle C of the Binding Theory, which requires R-expressions to be free. An example of Principle C violation is shown in (51a):

- (51) a. *He₁ likes John₁'s mother.
b. *[John₁'s mother]₂, he₁ likes t₂.
c. *[Whose₁ mother]₂ does he₁ like t₂?
d. [John₁'s mother]₂ seems to him₁ [t₂ to be sick] .

In English, Condition C Reconstruction effects are not found with A-movement (51d), but they are found with A'-movement (51b-c). Sentences (51b-c) are derived from (51a) via Topicalization in (51b) and Wh-movement in (51c). Thus ungrammatical D-Structure representations remain ungrammatical, after Topicalization and Wh-movement, due to obligatory Reconstruction. The

R-expressions reconstruct into their D-Structure positions where they are bound by the coindexed pronoun. Therefore, (51b-c) are ruled out as Condition C violations.

Russian shows standard cases of a Condition C violation (52):

- (52) *On_i uvažajet professora Ivana_i.
 he-NOM respects professor-ACC Ivan-GEN
 'He_i respects Ivan_i's professor.'

Just as for WCO, a double-object construction illustrates the SCO paradigm of binding possibilities. This is shown in (53)–(54):

(53) Quantified expression within Direct Object binds pronoun (Indirect Object):

- a. *Ivan pokazal emu_j fotografii každogo_j mal'čika. D-STRUCTURE
 Ivan-NOM showed him-DAT pictures-ACC every boy-CEN
- b. *Ivan [fotografii každogo_j mal'čika]_i pokazal emu_j t_i. VP-ADJUNCTION
 Ivan-NOM pictures-ACC every boy-GEN showed him-DAT
- c. *[fotografii každogo_j mal'čika]_i Ivan pokazal emu_j t_i. IP-ADJUNCTION
 pictures-ACC every boy-GEN Ivan-NOM showed him-DAT
 'Ivan showed him every boy's pictures.'

(54) Quantified expression within Subject binds pronoun (Indirect Object):

- a. *[Sestra každogo_j mal'čika] pokazala emu_j fotografii. D-STRUCTURE
 sister-NOM every boy-GEN showed him-DAT pictures-ACC
- b. *[Sestra každogo_j mal'čika] emu_j pokazala t_i fotografii. VP-ADJUNCTION
 sister-NOM every boy-GEN him-DAT showed pictures-ACC
- c. *Emu_j [sestra každogo_j mal'čika]_i pokazala t_i fotografii. IP-ADJUNCTION
 him-DAT sister-NOM every boy-GEN showed pictures-ACC
 'He showed the pictures to every boy's sister.'

The sentences in (53)–(54) are less clear with respect to the interaction between binding possibilities and reconstruction than the WCO examples in (46)–(47). All the examples where the pronoun precedes and binds into the referential DP are ungrammatical due to a Condition C violation. However, XP-Scrambling of the referential DPs above the pronoun does not rescue the sentences. It is not clear whether this is due to reconstruction or to other reasons, possibly having to do with focus which depends on intonation and stress assignment. For the examples like (53),

we can only say that reconstruction is possible, while for the cases with the subject as binder (54), in parallel to WCO (see (47) above), reconstruction is obligatory. Again, as for the WCO examples (46)–(47) above, the SCO sentences (53)–(54) with VP- and IP-adjunction sites do not differ with respect to their binding properties.

Japanese (Takahashi, 1995) also shows obligatory Condition C reconstruction effects with the subject binder (55):

- (55) a. ?*Kare₂-ga [John₂-no hahaoya]-o aisiteiru.
 he -NOM John -GEN mother -ACC likes
- b. ?[John₂-no hahaoya]₁-o kare₂-ga t₁ aisiteiru.
 John -GEN mother -ACC he -NOM likes
 'John's mother, he likes.'

To conclude, the Strong Crossover facts for Russian show either possible or obligatory Condition C reconstruction effects. A-movement never exhibits such effects (see the contrast in (44) above). Under an A-movement analysis, we would expect (53b)–(54b) to become acceptable, contrary to fact. We have to conclude that XP-Scrambling in Russian (just like in German, Korean, and Japanese) cannot be A-movement only.

2.4.2.5 Parasitic Gaps

Parasitic gaps (PGs) are used as a diagnostic of A'-movement because it has been established that only A'-moved phrases can license them (Chomsky, 1986); see (56a). Russian also exhibits constructions with PGs where overt Wh-movement occurs, as in (56b):

- (56) a. [What report]_i did he file t_i without reading PG_i?
- b. [Kakuju knigu]_i ty otdal t_i ne pročítav PG_i?
 which book-ACC you-NOM returned not reading
 'Which book did you return without reading through?'

It is easy to construct a parallel example with XP-Scrambling which is just as acceptable as the example with Wh-movement:

- (57) a. [Novuju knigu]_i my otdali t_i ne pročítav PG_i.
 new book-ACC we-NOM returned not reading

- b. My *otdali novuju knigu_i ne pročítav e_i*.
 we-NOM returned new book-ACC not reading
 'We returned the new book without reading through.'

(57a) is the sentence derived by Scrambling from the unscrambled example (57b). However, the existence of the empty category in (57b), a sentence without Scrambling, seems to undermine any argument that (57a) has a PG. Russian, just like Japanese and Korean, allows for null arguments, and it is possible that the empty category in both (57a) and (57b) is some sort of object *pro*. Unfortunately, then, it is not possible to establish whether (57a) is a true parasitic gap construction (licensed by overt movement), so we cannot be sure whether XP-Scrambling in Russian can license PGs, as would be expected of A'-movement.

2.4.2.6 Summary

The results of the discussion in Sections 2.4.2.1- 2.4.2.5 can be summarized in Table 2:

Table 2. Syntactic Properties of XP-Scrambling in Russian with Respect to the Landing Site

	ANAPHOR BINDING	WCO	ANAPHOR PREPOSING	CONDITION C RECONSTRUCT.	PARASITIC GAPS
CLAUSE- INTERNAL	can be A- movement	can be A- movement	can be A'- movement	cannot be A- movement	can be A'- movement

This discussion of syntactic properties of clause-internal XP-Scrambling in Russian leaves us with mixed results. Some standard syntactic tests that establish landing sites provide evidence for its A-movement nature (anaphor binding and WCO). Others (anaphor preposing and Condition C Reconstruction), support an A'-movement analysis. Thus, Russian XP-Scrambling appears to exhibit mixed properties associated with Scrambling in other languages for which a unified theoretical explanation is still under debate.

The descriptive properties of Russian XP-Scrambling discussed above can be formalized as language-specific parameter settings for Russian, within the Universal theory of Scrambling.

XP-Scrambling is a movement operation which moves an XP into a VP-adjoined position, as in (58a), or an IP-adjoined position, as shown in (58b):

- (58) a. Mal'čik [_{DP} knigu]_i čitaet t_i.
 Boy-NOM book-ACC is reading
- b. [_{DP} knigu]_i mal'čik čitaet t_i.
 [book-ACC] boy-NOM is reading
- c. Čitaet t_i knigu [_{DP} mal'čik]_i.
 Is reading book-ACC boy-NOM
 'The boy is reading the book.'

Two most obvious cases for VP-adjunction are Scrambling of object below the subject but above the verb, as in (58b) and Scrambling of subject (Right Extraposition), as in (58c). This parameterized theory of landing sites (see Müller and Sternefeld, 1993)¹⁸ is contrasted with the IP-adjunction-only analysis (Saito, 1985, and others). According to the latter, an object scrambled below the subject has to be IP-adjoined. The subject will have to move out of its SPEC, IP position and adjoin to IP above the scrambled object in order to derive the SOV surface word order. According to the parameterized theory of landing sites for Scrambling that I adopt here, a language may permit the scrambled object to be VP-adjoined while the subject stays in SPEC, IP. Everything else being equal, this analysis should be preferred over the IP-adjunction-only analysis because it is more general one and permits simpler derivations; thus, I will adopt the parameterized theory of landing sites here. Note that independently, King (1993), Bailyn (1995), and Junghanns and Zybatow (1995) propose arguments in favor of Right Extraposition (XP-Scrambling) of subjects, and show that the postverbal subject is VP-adjoined.

XP-Scrambling of subjects represents a crucial case of bidirectionality. It is plausible that other instances of XP-Scrambling can be rightward as well, e.g., adverb placement. Formal investigation of properties of rightward XP-Scrambling and its comparison with an alternative analysis along the lines of Kayne's antisymmetry (VP-Evacuation) hypothesis goes well beyond

¹⁸ Müller and Sternefeld (1993) assume VP and IP as possible landing sites, and also propose to include CP as a possible landing site to accommodate LD-Scrambling in Russian.

the scope of this dissertation. In Chapter 5 it will be argued that rightward FP-adjunction constitutes a second step in the Double-Movement analysis of Split Scrambling; therefore, rightward movement is needed independently from XP-Scrambling of subject. Thus, the landing sites parameter for XP-Scrambling has the values IP, VP (and FP) in Russian, while the direction of movement parameter is set as both left- and rightward.

2.5 Syntactic Properties of XP-Scrambling Cross-Linguistically

In Section 2.4, in order to establish the properties of XP-Scrambling in Russian, I applied a range of standard syntactic tests developed in the literature to identify A'- or A- properties of movement (Saito, 1985; Frank et al., 1992; Takahashi, 1995). These tests were shaped up in the debate on the nature of Scrambling in a variety of languages. The present section briefly summarizes the data, arguments and conclusions that have been presented in the literature. The discussion of Russian is resumed in Chapter 3.

Saito (1985) showed that the properties that Scrambling exhibits in Japanese require it to be analyzed as movement. Since Scrambling interacts with such phenomena as pronominal coreference, Crossover effects, and Quantifier Floating, Saito concluded that it had to be an overt S-Structure movement and not a stylistic rule applicable at PF.

Since Scrambling obviously affects maximal projections, it could not be an instance of Head Movement, but must be XP movement. Only two options (or a combination) were left to be tested – whether XP-Scrambling is an A'- or an A-Movement. The answer is to be found in the constraints it is subject to.

2.5.1 XP-Scrambling as A'-Movement (Saito 1985, 1992; Lee and Santorini, 1994; Frank et al. 1992; Müller and Sternefeld, 1993)

The best-studied instances of A'-movement are Wh-movement and Topicalization. Wh-movement is assumed to be a movement into SPEC, CP which can take place overtly in the syntax, as in English, or covertly, at LF, as in Japanese. Wh-movement creates an operator-variable relation where the trace must be properly bound. The term *Topicalization* subsumes different phenomena in different languages and as a result there is no agreement on its precise nature. Saito (1985) considers Topicalization in English to be an instance of A'-movement with adjunction to IP.¹⁹ Neeleman (1994) provides arguments for Topicalization in Dutch as A'-movement with properties identical to Wh-movement. Both are claimed to be operator movements into SPEC, CP: there is an overt Wh-operator in Wh-movement and a null operator in Topicalization. Müller and Sternefeld (1993) take Wh-movement and Topicalization in German both to be instances of A'-movement but with different properties. The differences have to do with the order of complementizer and topic, the Verb Second phenomenon and island effects. Müller and Sternefeld conclude that Topicalization in German moves a phrase into SPEC, T(topic)P which is a functional projection lower than the CP.

Standard instances of A'-movement, such as Wh-movement and Topicalization, are usually assumed to have the following properties (59):

- (59) (a) The moved element originates in a [+Case] position (for arguments) but the landing site is an A'-position which is [-Case]. This landing site is either an adjoined position or the SPEC of a functional projection higher than VP (SPEC, CP for example);
- (b) A'-Movement is subject to the Strong Crossover (SCO) and Weak Crossover (WCO) constraints;²⁰

¹⁹ Saito (1985) argues that topic in Japanese is base-generated in the sentence-initial position, and, therefore, Topicalization in Japanese is not a movement phenomenon.

²⁰ It is widely assumed in the literature that the SCO and WCO constraints and the context in which they apply, are universal (see Saito, 1985 for Japanese; Mahajan, 1990 for Hindi; Frank et al. 1992 for German).

- (c) It licenses parasitic gaps (PGs);
- (d) It can be long-distance;
- (e) It obeys island constraints (including the complex NP constraint, the coordinate structure constraint, the adjunct condition).

The properties of XP-Scrambling cross-linguistically (German: Lee and Santorini, 1992; Bayer and Kornfilt, 1994; Vikner, 1994; Frank et al., 1992; Haider, 1994; Müller and Sternefeld, 1993; Dutch: Neeleman, 1994; Hindi: Mahajan, 1994; Korean: Frank et al., 1992; Lee, 1993; Japanese: Saito, 1985, 1992; Latin: Ostafin, 1985) appear to resemble the properties of Wh-movement and possibly Topicalization. XP-Scrambling is uniformly leftward²¹ in verb-final languages such as Japanese, Korean, Hindi, German and Dutch. XP-Scrambling licenses parasitic gaps in all these languages. In Japanese, Korean and Hindi it can be long-distance as well as local, can cross a lexically filled complementizer, and LD-Scrambling obeys island constraints. In Germanic languages, XP-Scrambling is local, that is, clause-bound, with the exception of a certain class of infinitival complement clauses, but it can be multiple.

The many similarities between XP-Scrambling and Wh-movement have led Saito and Müller and Sternefeld among others to put the two together in the same class. However, there are a few problems with the A'-Movement analysis of XP-Scrambling. Bayer and Kornfilt (1992) and Haider (1994) argue against it on the basis of 1) binding, 2) parasitic gaps, 3) the types of phrases that can be affected by movement, and 4) island effects. I will sketch these points in turn.

As noted in 2.4.2.2, only A-movement creates new binding relations, as in (60), while A'-moved phrases must reconstruct at LF, as indicated by the judgments (61):

- (60) a. *It seems to his_i mother that [every boy]_i is intelligent.
 b. [Every boy]_i seems to his_i mother [t_i to be intelligent].

²¹ The leftward character of XP-Scrambling has been shown (see the language-specific references above) to be the consequence of at least three factors: the Proper Binding Condition for the trace of Scrambling, adverb placement (in German and Dutch), and final position of V in all SOV languages.

- (61) a. *His_i mother likes [every boy]_i.
 b. *[Which boy]_i does his mother like t_i?

If XP-Scrambling is an instance of A'-movement, then it should never change binding relations; reconstruction should be obligatory. However, German XP-Scrambling in the double-object construction can remedy a WCO violation, as in (62), a property associated with A-movement (cf. (61)):

- (62) a. *Ich glaube, daß der Jörg [seinem_i Vater]_i jeden_i gezeigt hat.
 I think that John his-DAT father everyone-ACC shown has
 b. Ich glaube, daß der Jörg jeden_i [seinem_i Vater]_i t_i gezeigt hat.
 'I think that John has shown his father everyone.'
 (Frank et al. 1992: (21))

XP-Scrambling as an instance of A'-movement should also be able to license PG. (63)

shows a minimal pair between Topicalization in German which licenses PGs, and XP-Scrambling which does not:

- (63) a. ?Diesen Mann_i hat man [ohne PG_i verwarnt zu haben] t_i ins Gefängnis gesteckt.
 this man has one without warned to have in the prison put
 'One has put this man into jail without having warned (him).'
- b. *Da hat diesen Mann_i der Polizist [ohne PG_i verwarnt zu haben] t_i ins Gefängnis gesteckt.
 there has this man the policeman without warned to have in the prison
 gesteckt.
 put
 'The policemen has put this man into jail without having warned (him).'

Extraction out of A'-adjuncts is prohibited, but according to Haider (1994), it is possible to extract a phrase out of the scrambled phrase in German (64):

- (64) Wen_i hat denn [damit t_i zu erschrecken] jemand beabsichtigt?
 who has with it to terrify someone intended
 'Who has someone intended to terrify with it?'
 (Haider, 1994: (9))

An additional difference between standard A'-movement and XP-Scrambling concerns which XPs can move. For example, in German, VPs, resultative predicates, verb-associated particles, idiomatic constructions with PP, subparts of DPs cannot scramble, but they can under both Wh-movement and Scrambling in Russian.

The interaction between Crossover and XP-Scrambling, in which XP-Scrambling exhibits A-movement properties, as in (62) above, constitutes the most commonly used argument against analyzing it as A'-movement. Lee and Santorini (1994) and Frank et al. (1992) in an attempt to reconcile A'-movement properties of XP-Scrambling with its ability to affect binding relations, proposed a special type of A'-position which would serve as the landing site for scrambled phrases. They claim that XP-Scrambling in German and Korean is A'-movement to a non-operator A'-position. The scrambled element can license a PG as a result of being in an A'-position, but because it is in a non-operator position, it does not have to reconstruct, making it possible to remedy WCO and SCO²² violations. This solution, however, has not been widely accepted by most syntacticians who work on XP-Scrambling. Instead, the problems raised by the A'-movement analysis of XP-Scrambling have led other researchers to try to analyze XP-Scrambling under certain conditions as an instance of A-movement similar to Passive and Raising.

2.5.2 XP-Scrambling as A-Movement (Mahajan, 1990; 1994; Young-Suk Lee, 1993)

A-Movement is standardly assumed to have the following properties (65):

- (65) (a) It is driven by the requirements of Theta-theory and Case theory: the launch site is [-Case], and the landing site is a [+Case] A-position, which is usually a SPEC of a higher projection;
- (b) It can create or destroy binding relations, that is, reconstruction does not (necessarily) occur;
- (c) It affects only DPs;
- (d) It does not license PGs;
- (e) It is strictly local (clause-bound);

²² Frank et al. noticed that the WCO data do not license conclusions as strong as those licensed by the SCO data. In the case of a subject binder in WCO situations, the relevant WCO data imply only that reconstruction is possible. (See Frank et al., 1992, for details).

(f) It is obligatory.

Notice that one of the structural differences that is said to distinguish A'-movement and A-movement is the assumption that the former may adjoin the moved phrase to some higher projection, as well as substitute into a SPEC position, while the latter only substitutes it into the SPEC of some higher projection in which it can receive case. Advancement of the theory of Functional projections (Abbey, 1989; Pollock, 1989) allowed Mahajan (1990; 1994) to propose a radically different solution to the puzzling mixed properties of XP-Scrambling.

Mahajan distinguishes two different types of XP-Scrambling: Argument Shift and Adjunction to XP, both of which are instances of Move α . Argument Shift in Germanic languages is Object XP-Scrambling. It moves a DP into a SPEC position of a functional projection other than CP within the same clause. This movement is Case-driven in the sense that if a DP does not have a lexical Case, it must move out of its Caseless D-Structure position to a different S-Structure position where it will receive Case. Since structural Case assignment proceeds through the SPEC-head agreement relation, this S-Structure position has to be a SPEC position of a higher projection, such as TP, Agr_oP, Agr_sP, and AuxP. If it has a lexical Case, it does not have to move. Argument Shift precedes application of the Binding theory, and therefore overrides WCO effects, and is not reconstructible.

Mahajan shows that Argument Shift in Hindi (which like German, is also an underlying S IO DO V language) has the properties of an A-Movement. For example, fronting of a direct object overrides WCO effects with pronominal binding, as shown in (66) (on a par with the German example (63b) above):

- (66) [sab daasiyaaN_i raajaa-ne unke_i pitaa-ko [_{t_{sub}} t_{IO} t_{DO} LOTAA diiN]].
 all maids-DO king-SUB their father-IO return give-F-PL
 'The king returned all the maids_i to their_i father.'

Second, Argument Shift does not undergo reconstruction either for Condition A or for Condition C effects, illustrated for Condition C in (67):

(67) a. *mE-ne use_i raam_i ki kitaab dii.
 I-SUB him-IO Ram GEN book give
 lit. 'I gave to him Ram's book.'

b. mE-ne raam_i ki kitaab_j use_i t_j dii.
 I-SUB Ram GEN book him-IO give
 lit. 'I gave Ram's book to him.'

(Mahajan 1992: (18)-(20))

On the basis of these arguments Mahajan established a difference between Argument Shift and Adjunction to XP in Hindi. Thus, Adjunction to XP shows WCO effects and does not create new binding possibilities. Mahajan concludes that Hindi XP-Scrambling must be viewed as two distinct operations: an Argument Shift operation and an Adjunction to XP operation. Argument Shift involves substitution, and it shows binding properties normally associated with A-Movement. Adjunction to XP, on the other hand, shows properties associated with A'-Movement.

Lee (1993) compares the properties of three distinct syntactic processes in Korean: Left-Dislocation, Topicalization and XP-Scrambling. She shows that in Korean, both a subject and an object move out of VP at S-Structure in order to receive Case, and the moved arguments can be arranged in any order for the purpose of case licensing, giving rise to scrambling effects. Thus, according to Lee, XP-Scrambling in Korean is defined as case-driven obligatory A-movement which derives non-base word orders by moving phrases into adjoined positions at IP, which behave as A-positions.

In Lee's account, the two major problems for the A-movement theory of XP-Scrambling (licensing of PGs and occurrence of limited reconstruction) are solved as follows. There are no standard PGs in Korean, but only empty pronouns which must be bound by scrambled phrases (68). As evidence, she notes that Korean PGs do not obey Subjacency, in contrast, to English PGs in (69) (Chomsky, 1986):

- (68) John-i etten pyenci_i-lul [_{RC1} t_i [_{RC2} t_i e_i ponay-n] yeca_i-lul ciltwuha-nun]
 John-NOM which letter-ACC send-REL woman-ACC be-jealous-of-REL
 caki-pwuin_i-eykey t_i poye cwuess-ni.
 self's wife-DAT showed-QM
 'Which letter_i did John show e_i to his wife who is jealous of the woman who sent t_i?'
 (69) *This is the man John interviewed t_i before giving the book to PG_i.

In order to explain limited reconstruction, Lee adopts the analysis proposed by Frank et al. (1992) according to which the subject has a special status in binding relationships. Under Lee's analysis all the arguments in Korean, including the subject, must undergo Scrambling to receive Case. Thus, XP-Scrambling acquires the status of an obligatory movement, obviating criticism based on the Economy approach where movement is considered as the Last Resort (Chomsky, 1991; 1992).

However, the A-movement account of XP-Scrambling faces as many problems as the A'-Movement account. Bayer and Kornfilt (1992) and Frank et al. (1992) show that these problems have to do with analysis of PGs and anaphor binding. First, XP-Scrambling does license PGs, while typical A-movement does not. Mahajan's analysis of XP-Scrambling does not suffer from this drawback, because it distinguishes two types of XP-Scrambling in Hindi: Object Shift and Adjunction to XP. Adjunction to XP is an A'-movement, and, therefore, can license PGs. Lee (1993) solves the problem of PG licensing by claiming that the so-called parasitic gaps in Korean and Japanese are not real gaps. Similarly, Haider (1994) argues that there are no classical PGs in German and, therefore, there is no need to be concerned about A'-chains.

The second problem that the A-movement account of XP-Scrambling faces is anaphor binding. Frank et al. (1992) notice that there is a discrepancy between pronoun and anaphor binding in WCO and SCO cases making it difficult to use these constraints with anaphors to distinguish between A'- and A-positions.

Another concern about the A-movement analysis of XP-Scrambling is that serious problems arise in relation to Long-Distance Scrambling. LD-Scrambling allows a phrase from an

embedded clause to scramble to the matrix clause, sometimes across a complementizer, and in doing so, it crosses barriers, as is the case in the German “Third Construction” (70):

- (70) weil Heinrich den Wagen_i versprochen hat [PRO t_i zu waschen].
 since Heinrich the car promised has to wash
 ‘because Heinrich has promised to wash the car.’ (Bayer and Kornfilt 1992: (12))

The scrambled object DP, *den Wagen_i* ‘the car’, crosses two barriers on the way up. A-movement, which is strictly local, should be impossible under these circumstances.

The A-movement analysis of XP-Scrambling also faces some theoretical problems (Bayer and Kornfilt, 1994) concerning motivation and the economy of derivation. Consider the problem of the functional motivation for XP-Scrambling. Scrambled elements are assigned Case already in their D-Structure positions, and, therefore, do not need to scramble to satisfy Case requirements. The solution proposed by Lee (1993) for Korean, according to which Case is not assigned within VP at D-Structure, so Case requirements do drive XP-Scrambling in this language may not be available for all the scrambling languages. Bayer and Kornfilt (1994) show that German Quantifier Floating has properties of movement to an A-position, but the quantifier left behind is Case-marked. This suggests that XP-Scrambling of DPs cannot be universally Case-driven.

The lack of functional motivation for XP-Scrambling presents only one aspect of the problem. The other closely related aspect is the optionality of XP-Scrambling. XP-Scrambling is almost always optional while standard instances of A-movement are always obligatory. Neeleman (1994) remarks that this optionality of XP-Scrambling presents a problem for the Minimalist program (Chomsky 1995), according to which movement obeys principles of economy: no movement can take place unless there is a trigger for it. Only recently, an interesting solution to the lack of functional motivation/optionality for XP-Scrambling has been proposed, under which it is driven by Focus considerations (see Chapter 3 for discussion).

Finally, the issue of the exact number of functional categories and their hierarchical order raises theoretical problems for the A-movement analysis of XP-Scrambling. A-positions are defined as SPEC positions of functional projections (and as complement positions of lexical

projections). A scrambled phrase has to move to a SPEC position, and each functional projection has only one such position. In cases of multiple XP-Scrambling we would have to postulate different orders of Agr phrases depending on the order in which scrambled phrases appears at S-Structure. Yet it is desirable to assume that these functional projections have a universal hierarchical order.

When so many problems arise with either a purely A'-movement or A-movement analysis of XP-Scrambling, it seems natural to try to merge the two approaches and test whether a non-uniform analysis of XP-Scrambling is more satisfactory.

2.5.3 XP-Scrambling as Non-Uniform Movement (Webelhuth 1989; Mahajan, 1994; Vikner, 1994; Neeleman, 1994)

Webelhuth (1989) discussed two classes of examples from German and argued that XP-Scrambling can behave like A-movement as well as A'-Movement because the landing site possesses properties of both A'- and A-positions. These cases involve parasitic gap constructions with binding of a pronoun, as in (71), but they are apparently created by the XP-Scrambling of the direct object:

- (71) Peter hat jeden Gast_i [ohne PG_i anzuschauen] seinem_i Nachbarn t_i vorgestellt.
 Peter has every guest without to look at his neighbor-DAT introduced
 'Peter introduced every guest to his neighbor without looking at him/her.'

Webelhuth claims that the scrambled phrase *jeden Gast_i* is in a mixed position because it can bind the pronoun and also license a parasitic gap in the adjunct clause *[ohne PG_i anzuschauen]* 'without to look at'. This property of a scrambled element to create pronoun binding and at the same time to license a parasitic gap has become known in the literature as *Webelhuth's paradox*.

Mahajan carefully examined Webelhuth's data from German and the data from Hindi and came to the conclusion that sentences like (80) can have an alternative derivation which obviates the necessity of introducing a mixed position. The movement of the scrambled phrase proceeds in two steps: first the phrase moves into SPEC, Agr_oP, and from this position it will bind

the pronoun. Second, it moves higher up to adjoin to the IP containing the adjunct. Mahajan argued that it is possible to separate these two movement steps and thus to distinguish two types of XP-Scrambling: the first type, Object Shift (discussed in Section 2.5.2), is an A-movement, while the second type, Adjunction to XP, is an A'-movement. XP-Scrambling as substitution involves movement of a scrambled phrase into SPEC positions of the functional projections TP, Agr_oP, Agr_sP. XP-Scrambling as Adjunction to XP involves adjunction to the same functional projections TP, Agr_oP, Agr_sP, and possibly VP too. It shows the same properties as standard A'-Movement: it does not enter binding theory, shows WCO effects, can be non-local (subject to the ECP and Subjacency) and is reconstructible.

Lee and Santorini (1994) provide (72a) as a counterexample for Mahajan's explanation for Webelhuth's paradox:

- (72) a. ?daß Maria jeden_i seinem_i Nachbarn [ohne PG_i anzuschauen t_i] vorgestellt hat.
 that Mary everyone his neighbor-DAT without to look at introduced has
 'that Mary introduced everyone_i to his_i neighbor without looking at him_i.'
 (Lee and Santorini 1994: (21))

- b. *[The article] was filed t_i without reading PG_i.

The relative acceptability of (81a) is unexpected given Mahajan's assumptions. If *jeden* 'everyone', which licenses the PG, has scrambled via an A-position from which it binds the pronoun *seinem* 'his', then the derivation violates standard assumptions concerning licensing of PGs. In this case, the scrambled quantified phrase (or its trace) in the A-position illicitly c-commands the PG, and the clause (72a) should be ungrammatical as in the parallel English sentence (72b). On the other hand, if *jeden* scrambled directly to an A'-position, then XP-Scrambling should license reconstruction more generally than it does.

Vikner (1994) proposed to solve Webelhuth's paradox by distinguishing between XP-Scrambling and Object Shift in a way similar to Mahajan's approach; however, he refers to these processes as "two types of object movement in the Germanic languages". Object movement in the Germanic SVO languages (Danish and other Scandinavian languages and Faroese) has different

properties from object movement in the Germanic SOV languages (Afrikaans, Dutch, Flemish, Frisian, German and Yiddish) with respect to such properties as PG licensing, Case assignment, landing site, and V Raising. Vikner refers to the first type as Object Shift, and to the second type as XP-Scrambling.

Vikner argues that Object Shift and (Object) XP-Scrambling are in complementary distribution, that is, only Scandinavian languages possess Object Shift while German and similar Germanic languages only have XP-Scrambling. If so, it is possible to hypothesize that both are adjunctions to VP/TP/Agr_oP (and possibly IP) where Object Shift is A-movement, whereas XP-Scrambling is A'-movement. The complementary distribution of Object Shift and XP-Scrambling in Germanic languages allows Vikner to propose a parameter according to which in Object Shift languages the adjoined position of scrambled phrases is an A-position to which Case can be assigned, while in XP-Scrambling languages it is an A'-position. For example, in Object Shift languages a PP object cannot move, and a DP object or floating quantifier cannot be moved to a position between two adverbials, precisely because the adjoined position for scrambled phrases in these languages is a Case-assigning A-position. While Vikner's analysis of XP-Scrambling in general is not strictly a non-uniform movement type analysis, because it is based on a language-particular parameter, it nevertheless is a mixed position approach.

Tada (1993) takes this general idea about the non-uniform nature of XP-Scrambling one step further, suggesting that there is a correlation between the distance of XP-Scrambling and the possibility of having properties of A-Movement. S(hort)-Scrambling is XP-Scrambling of direct object over indirect object, and it shows properties of A-Movement. M(iddle)-Scrambling is XP-Scrambling of an object whether direct or indirect over subject, and it may or may not show properties of A-Movement. L(ong-Distance)-Scrambling is always an A'-Movement. Thus Tada argues for three different types of XP-Scrambling. His S-Scrambling is identical to Mahajan's Object Shift, and his L-Scrambling is the same as long-distance examples of Mahajan's Adjunction to XP. M-Scrambling is a separate type, because it behaves as A-Movement with respect to some

syntactic tests and as A'-Movement with respect to the others, as shown in Table 3 (cf. Table 2 above):

Table 3. Properties of S-, M- and L-Scrambling in Japanese

PROPERTIES	S-SCRAMBLING	M-SCRAMBLING	L-SCRAMBLING
WCO-NEUTRALIZATION	A-Movement	A-Movement	A'-Movement
RECIPROCAL BINDING	A-Movement	A- and A'-Movement?	A'-Movement
SCO	A-Movement	A'-Movement	A'-Movement
ADJUNCT EXTRACTION	A-Movement	A'-Movement	A'-Movement

2.5.4 Summary

Section 2.5 has stepped back from the Russian data to look at the problem of XP-Scrambling from a more general point of view. The earlier approaches to XP-Scrambling as movement (Saito, 1985; Frank et al. 1992 and others), showed that XP-Scrambling in Japanese, German, and Korean exhibits properties similar to those of Wh-movement, the classical case of A'-movement: it moves phrases into an adjoined position, exhibits SCO and WCO effects with bound pronouns, licenses PGs, can be Long Distance, and obeys standard island constraints. However, it was also shown to be different in some aspects from both WH-Movement and Topicalization (Müller and Sternefeld, 1993) in that the facts concerning PGs are rather complicated and not clear cut (Haider, 1994; Lee, 1993), anaphor binding behaves rather differently from pronoun binding, and all the languages exhibit restrictions of one type or another with respect to what maximal projections can be affected by XP-Scrambling. These facts brought some researchers to consider a different approach to XP-Scrambling and to link it to instances of A-movement, such as Passivization and Raising (Mahajan, 1990; Lee, 1993). However, while solving some of the problems raised by the A'-movement approach, the A-movement analysis had to explain the obvious A'-properties of XP-Scrambling. In addition to the empirical problems

of SCO and WCO effects, possible Long Distance movement, and licensing of PGs, the A-movement approach faced theoretical problems, such as the proliferation and universal hierarchical order of functional projections, as well as the problem of the lack of the functional motivation/obligatoriness for XP-Scrambling.

As it became obvious that neither the A'- nor the A-movement approach is completely satisfactory, a third class of analysis of XP-Scrambling has emerged. XP-Scrambling is claimed to exhibit both sets of properties; it is a non-uniform movement. This approach (Mahajan, 1994; Vikner, 1994; Tada, 1993) is based on the hypothesis that XP-Scrambling can be either an A'-movement or an A-movement depending on different factors, for example, on the distance of movement of the scrambled phrase and its syntactic position. It seems to accommodate the complexities of the empirical facts (binding, types of XPs affected, etc.) better than the two uniform movement approaches. The non-uniform movement analysis utilizes familiar principles, so that the theory itself is no more complex, though it predicts a more complex array of phenomena. Therefore, this class of approaches seems to be the most promising of the three, though there seems to be a general sense that it does not yet have the elegance of a fully principled theory.²³

²³ Finally, it is important to mention that a fourth class of approaches has recently evolved within the GB/Minimalist theory. Bayer and Kornfilt (1994), Haider (1994), Neeleman (1994), and Bošković and Takahashi (1995) argue for XP-Scrambling as a base-generated phenomenon. Their analyses investigate this possibility drawing on data from German (Bayer and Kornfilt, 1994; Haider, 1994), Dutch (Neeleman, 1994) and Japanese (Bošković and Takahashi, 1995). The general idea that unites all these accounts is that it is not necessary to assume adjacency between the verb and its objects in order to satisfy Case and Theta theories. The mechanisms used to assign Case and theta-roles are: Complex Category Formation (Bayer and Kornfilt, 1994), thematic hierarchy (Neeleman, 1994), licensing of scrambling positions as checking positions (Haider, 1994), LF-Lowering (Bošković and Takahashi, 1995). Complex Category Formation allows certain heads (V and I) to make their complements visible along their projection line. Language-particular thematic hierarchy specifies not only the number but also the ordering of theta-roles that are carried over to the syntax. Direct licensing of Scrambling is based on a hypothesis that scrambling positions are checking positions. According to LF-Lowering, "scrambled" phrases are base-generated in the surface positions and undergo movement at LF to the positions where they are assigned theta-roles. Since the focus of this dissertation is the movement approach to XP-Scrambling, I will not discuss the base-generated approaches any further.

2.6 Summary of Chapter 2

A thorough linguistic investigation of XP-Scrambling in the world's languages is just beginning and has as yet only scratched the surface. Its goal is to provide a universal theory of Scrambling, if that is possible, and otherwise to identify and distinguish the phenomena that have been grouped together in the belief that they are homogeneous. Even among typologically and genealogically related languages like the Germanic languages, for example, many differences are found. Data from other language groups can add a further perspective on the range of facts that a universal theory of Scrambling would have to be responsive to.

I have drawn on convincing arguments in the literature that Russian is configurational and its canonical word order is SVO, with other surface word orders derived from SVO by XP-Scrambling. There are tentative reasons to believe that other instances of movement such as Wh-movement, Topicalization, and Right Extraposition, although distinct processes in other scrambling languages, in Russian could be subsumed under XP-Scrambling.

In this chapter, it has been observed that the standard syntactic tests standardly used in the literature to distinguish the landing site of movement as A'- vs. A-positions (tests involving anaphor binding, WCO and SCO, and parasitic gaps) reveal that Russian XP-Scrambling primarily uses A'-positions as landing sites (a possible exception being linear serializations of objects in the double-object construction). Russian is more permissive than other languages with respect to the range of scrambling operations it allows. The two following parameters characterize XP-Scrambling in Russian:

- Landing Sites: VP, IP,;
- Direction: leftward, rightward.

Thus, the landing sites for XP-Scrambling include not only IP-adjunction, as is the case for other scrambling languages, but also VP-adjunction, the two most important cases of which are Short object Scrambling (below the subject) and XP-Scrambling (Right Extraposition) of subject in

constructions with postverbal subjects. Finally, in contrast with other scrambling languages, XP-Scrambling in Russian can proceed in either direction, leftward and rightward. Right VP-adjunction is the landing site for scrambled postverbal subjects.

XP-Scrambling in Russian is discourse-oriented in the sense that discourse circumstances impose a particular Focus structure on sentences, and Focus considerations motivate XP-Scrambling. Chapter 3 presents a Focus-driven analysis of XP-Scrambling.

Chapter 3. Discourse Properties of XP-Scrambling

3.1	Introduction	80
3.2	XP-Scrambling and Focus (Reinhart, 1995)	81
3.3	Functional Analyses of XP-Scrambling	86
3.3.1	Introduction	86
3.3.2	XP-Scrambling as Discourse-Driven S-Structure Movement (King, 1993) ..	87
3.3.3	Extraposition, IP- and VP-Adjunction and the Functional Form Hypothesis (Bailyn, 1995)	91
3.3.4	F-Scrambling and N-Scrambling, and the I-Structure Hypothesis (Kondrashova, 1996)	97
3.3.5	Information-Structure (Junghanns and Zybatow, 1995)	102
3.3.6	Summary	105
3.4	XP-Scrambling in Russian and the Syntax-Phonology Interface	108
3.5	Summary of Chapter 3	118

3.1 Introduction

The discussion in Chapter 2 has concentrated on an attempt to clarify the nature of XP-Scrambling with respect to its structural properties, including the particularly difficult question of whether its landing sites are A- or A'-positions. Tada (1993) refers to this as *the problem of the landing site*. This problem has been addressed by all recent studies of scrambling languages, as discussed in Section 2.5. However, there is another problem, *the problem of optionality*: What syntactic force drives XP-Scrambling? It is usually said that XP-Scrambling is optional. In the Minimalist framework (Chomsky, 1995), optionality presents a challenge, because all movements must be obligatorily driven by feature-checking. For example, Topicalization occurs because there is an optional feature [+topic] which needs to be checked off. The topicalized phrase moved into this position does the checking and thus justifies the movement.

Along the same lines, XP-Scrambling can be conceived of as moving a phrase with a particular feature into a position where this feature can be checked off. This feature has to be strong in order for XP-Scrambling to occur overtly in the syntax. However, this is just a formal implementation of this operation. To be explanatory, the theory must identify what the nature of this feature is. We can hypothesize that the feature that triggers Scrambling is assigned as a part of discourse requirements which make a sentence felicitous in context. These discourse requirements impose a particular Focus structure on the sentence. In order for the syntactic structure of the sentence to meet them and receive the required Focus structure, certain operations have to occur, one of which is Scrambling. I propose that the strong feature in question is [-SS], i.e., no sentential stress. The goal of XP-Scrambling can be understood as that of taking a phrase and removing it from the domain of default Sentential Focus. Once it is IP- or VP-adjoined, the scrambled phrase is separated from the rest of the syntactic structure to which the Generalized Stress Rule applies, so some other phrase will be assigned default Sentential Focus instead. The scrambled phrase may be unfocused, or an additional procedure which is

implemented through prosodic means can optionally assign a special constituent stress [+CS] to this scrambled phrase resulting in Constituent Focus. Since XP-Scrambling as a tree-splitting procedure, and Focus assignment via prosody, are two separate operations, it is possible to assign Constituent Focus to a phrase *in situ* as well as to a scrambled phrase. This will account for the seemingly free variation between XP-Scrambling and prosodic marking as the means of expressing Focus in Russian.

The hypothesis that Scrambling is motivated by Focus requirements comes from Reinhart (1995) who proposes such an analysis for Object Scrambling in Dutch. I will briefly review Reinhart's account in Section 3.2. Establishing the motivation for XP-Scrambling is important; in traditional research (Prague school, Soviet linguistics), it has been argued that word order variation is discourse-oriented, and there are numerous proposals within the framework of functionalism of how to account for surface word order variation in this language (see Bailyn, 1995, for detailed discussion). Recently, several accounts have appeared in the literature which strive to integrate the functional concepts of traditional grammar with the formal apparatus of current syntactic theory. I will turn to the discussion of these proposals in Section 3.3. Finally, in Section 3.4 I will sketch an account of the motivation for XP-Scrambling in Russian along the lines of Reinhart's theory.

3.2 XP-Scrambling and Focus (Reinhart, 1995)

Reinhart starts by examining the semantic theory of XP-Scrambling in Dutch proposed by de Hoop (1992). It is claimed by de Hoop that there is a correlation between such semantic characteristics of a DP as familiarity, d-linking, specificity, etc. and its ability to scramble (1):¹

¹ In what follows, I will use the following convention to represent the main sentential stress, emphatic stress, and focus:

main sentential stress (=default Sentential Focus):	the syllable is capitalized
emphatic stress (=narrow Constituent Focus):	the syllable is capitalized in bold
focused constituent:	the constituent is underlined

- (1) a. omdat ik altijd EEN KAT heb. UNSCRAMBLLED
 because I always a cat have
- b. *omdat ik EEN KAT altijd heb. SCRAMBLED
 because I a cat always have

In (1a), the direct object *een kat* 'a cat' is in its D-Structure position, and the sentence is grammatical. In (1b), this direct object is scrambled as can be seen by the immediate preverbal position of the adverb *altijd* 'always', and the sentence becomes ungrammatical. Reinhart argues that, in fact, what is important in these examples is not the semantic characteristics of the scrambled DP, but the prosodic characteristics of the sentences. In the unscrambled version (1a), main sentence stress falls on the object *een kat* 'a cat', while in the scrambled version (1b), it falls on the verb. Reinhart goes on to propose that

"certain types of movement (or other structural choices, like adjunction) are motivated by PF (phonological or prosodic) reasons. These PF considerations, on their part, may interact with the focus structure of the sentence." (Reinhart, 1995: 59)

Object XP-Scrambling in Dutch is argued to be precisely such a movement motivated by Focus considerations. It is acceptable if and only if the resulting focus structure is well-formed.

To support her hypothesis, Reinhart uses Cinque's (1993) theory of stress and focus. The main idea behind Cinque's theory is that the main stress of the sentence will be on its most embedded constituent. In a two-sister node configuration, the most embedded node is identified as the one that occurs on the recursive (branching) side of the tree. In a canonical right-branching language like English, in the VO structure, the object is the most embedded node. In Dutch, which is a left-branching language, in the OV configuration, the object is also the most embedded node. The stress will fall on the object and will project according to the Generalized Stress Rule which locates the stress (asterisk) of line N on line N+1. Here is a sample Dutch derivation:

- (2) ... (dat) ik het BOEK las.
 I the book read
 [ik [[het boek] las]]

- a. word stress: [^{*} [[*] *]]²
 b. NP cycle: [[[*]]]
 c. VP cycle: [[*]]
 d. IP cycle: [*] (Reinhart 1995: (22))

Notice that this account of sentence stress is independent of any discourse considerations. However, it is generally held that sentence stress interfaces with the theory of discourse via the notion of Focus. Focus is defined as the most informative part of an utterance and is usually identified by prominent stress. Then following up on the logic of Cinque's analysis, the set of possible (neutral)³ foci in a sentence is determined by its main stress. There are two possibilities. Either the neutral focus intonation will mark the entire sentence as new information, or only one constituent will be marked as the focus, and the rest of the sentence will not be included in the new information material. Reinhart adopts the following rule from Cinque (1993):

- (3) *The Focus Rule:* The Focus of IP is a(ny) constituent containing the main stress of IP, as determined by the stress rule.

The stress is determined cyclically (see (2)) by assigning to each new cycle the main stress on the previous one, and the Focus Rule allows that each of these constituents can serve as the Focus. This means that with this main stress, a sentence, like the English sentence *I am reading the book*, can be uttered in contexts in which it is appropriate for any of the three constituents (NP, VP, IP) to serve as Focus:

- (4) a. What is happening? - [I am reading the BOOK]_F.
 b. What are you doing? - I [am reading the BOOK]_F.
 c. What are you reading? - I am reading [the BOOK]_F.

Examples (4) illustrates that the main stress on *the book* enables the sentence to be used in a variety of contexts, since it allows several possible foci. Constituents not included in the focus set

² The other two word stresses in the word cycle of the derivation (2) do not project; they remain word-level stresses, and, therefore, not prominent for purposes of the cycles above the word level.

³ Marked stress is used to change the neutral (default) focus, as will be sketched below (see (5)).

in (4) are V and the subject. In order to focus such constituents as V and the subject, a separate rule (5) is needed.

(5) *Marked Focus Rule*: Relocate the main stress on a constituent you want to focus.

The application of rule (5) is shown in (6), for V and the subject, respectively:

- (6) a. Are you looking for the book? - I am [READING]_F the book.
 b. Who is building a desk? - [My NEIGHbor]_F is building a desk.

Here there is no option of wide focus, as under (3).

Compared to neutral stress, marked stress is uneconomical in the minimalist sense, because it involves an additional operation. A language like English can use passive and a few other rearrangements to move a constituent to a position where (3) will apply to achieve the intended focus interpretation. Other languages, like Italian, use word order variations instead of marked stress:

- (7) a. Johnson e' morto.
 b. E' morto Johnson.
 c. *JOHNson e' morto.
 'Johnson died.'

(Reinhart 1995: (33))

In (7a), the subject raises over the unaccusative verb and cannot receive the Focus which it otherwise would receive, being in the most embedded position. The generalization which Reinhart proposes is that movement out of VP may be due to phonological reasons, the need to change the stress pattern, i.e., the sentence's focus structure. This analysis, as Reinhart shows, can be successfully applied to account for Object XP-Scrambling in Dutch.

When the object scrambles, it is not in a complement position any more; it is now in an adjoined position, higher than V'. Therefore, the most embedded node in the sentence is the verb, and it now receives the neutral sentence stress (8b):

- (8) a. dak ik gisteren het BOEK las.
 that I yesterday the book read

- b. dat ik het boek gisteren LAS.⁴
that I the book yesterday read

The sentence (8a) has the focus set {IP, VP, O} while (8b) has {IP, VP, V}. Therefore, it appears that a major reason to prefer a scrambling structure over a non-scrambled one would be to allow the verb to receive the Focus. Instead of using the marked focus rule, an option that English employs, Dutch uses XP-Scrambling.

The hypothesis that Object XP-Scrambling in Dutch is motivated by Focus considerations can be tested further. First, XP-Scrambling of an object should be impossible when the verb is not a good potential focus, as indeed is the case with the light verbs (see example (1) above). Second, a pronoun will obligatorily scramble because it cannot carry the main stress:

- (9) *Ik heb gisteren het gelezen. vs. Ik heb het gisteren gelezen.
'I did not read it yesterday.'

Finally, the intuitions with respect to the specificity or definiteness effects of XP-Scrambling, (e.g., that definites scramble better than indefinites), also follow from the Focus analysis of XP-Scrambling. It is generally the case that indefinites are better foci, because they represent new information. Therefore, they do not scramble, but stay in the position where they are focused. Even definites, however, are restricted in their ability to scramble by the appropriateness of the resulting focus structure:

- (10) a. *Ik heb [de krant]_F nog niet geLEzen, maar ik heb [het boek]_F al wel geLEzen.
I have newspaper not yet read but I have the book already indeed read
b. Ik heb nog niet [de KRANT]_F gelezen, maar ik heb al wel [het BOEK]_F gelezen
'I have not read the newspaper yet but I have already read the book, indeed.'
(Reinhart 1995): (48)-(49)

In (10a), there is a mismatch between focus and stress, in contrast with (10b), and it renders the sentence hardly processable. Reinhart argues that all these facts point toward the focus account rather than the semantic account of Object XP-Scrambling in Dutch.

⁴ Following Reinhart's logic, adjuncts can only be focused by the Marked Stress Rule (5).

Reinhart observes that the logic of this analysis is that Focus is essentially a matter of PF. Independent discourse considerations determine where stress must be assigned in a sentence, and the stressed constituent signals focus. The Generalized Stress Rule (Cinque, 1993) applies first, which is dependent exclusively on the syntactic structure. Next, the focus rule relates stress and syntactic structures to focus. Each derivation is associated with a set of possible foci, namely, a set of constituents that can serve as the focus of the derivation in a given context. This association happens at the stage where both the syntactic tree and stress are visible. What stage is this? Reinhart proposes that this stage is a more general PF construed as an interface where the full syntactic tree is represented (up to the stage of Spellout), including all additional properties like stress, feature erasure and other phonological processes. Next, one member of the focus set is selected as the actual focus of the sentence and discourse conditions determine whether a derivation with this focus is appropriate for a given context. Any stress pattern other than that determined by the stress rule is considered marked.

Reinhart's insight into the relationship between XP-Scrambling, focus and discourse circumstances looks very promising for a scrambling language like Russian which is traditionally observed to be strongly discourse-oriented. Recent syntactic studies of word order variation in Russian conducted within the GB theory and the Minimalist program have concentrated exactly on this topic. We will now turn to the discussion of these studies (Section 3.3).

3.3 Functional Analyses of XP-Scrambling in Russian

3.3.1 Introduction

Recently, a number of interesting studies of Russian word order, particularly Scrambling, have appeared within GB and the Minimalist program (King, 1993; Bailyn, 1995; Kondrashova, 1996; Junghanns and Zybatow, 1995, among others). The main goal of these studies is to describe

and explain the freedom of surface word order in Russian and also to provide a functional analysis of what motivates XP-Scrambling in this language.

What follows is a compilation of functional analyses of clause-internal XP-Scrambling in Russian represented by King (1993), Bailyn (1995), Kondrashova (1996) and Junghanns and Zybatow (1995) which combine formal apparatus of current syntactic theory and traditional functional categories of the Prague school. Some readers may wish to skip this detailed discussion in Sections 3.3.2 - 3.3.5. It provides background information on functional motivation for Russian XP-Scrambling which is contrasted with the Focus-driven analysis tentatively proposed in this dissertation (Section 3.4). This background information is also relevant for understanding the syntactic characteristics of Russian experimental sentences tested in the processing study (Chapter 4).

The present section addresses recent syntactic analyses of clause-internal XP-Scrambling in Russian, and its relationship to the notions of given (Topic) vs. new (Focus) information. It is shown to reflect the discourse circumstances, either in the syntax (King, 1993), or arguably, at a new, abstract level of representation referred to as Functional Form (Bailyn, 1995), I-Structure (Kondrashova, 1996), Information-Structure (Junghanns and Zybatow, 1995).

3.3.2 XP-Scrambling as Discourse-Driven S-Structure Movement (King, 1993)

King (1993) establishes the configurationality of the Russian clause and argues for the conclusion that Russian canonical structure is VSO. The structure she proposes is the following (11):⁵

⁵ King (1993) notes that there is no real empirical or theoretical difference between calling the node between CP and VP either I⁰ or Σ⁰, as long as the head has a structure (i):

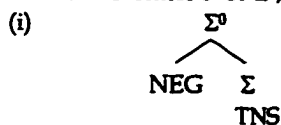

King uses the notation Σ to show that this position is not simply for inflectional features. It can also host negation and predicate adverbs. King claims, in addition, that SPEC, ΣP is not a subject but a focus position in Russian.

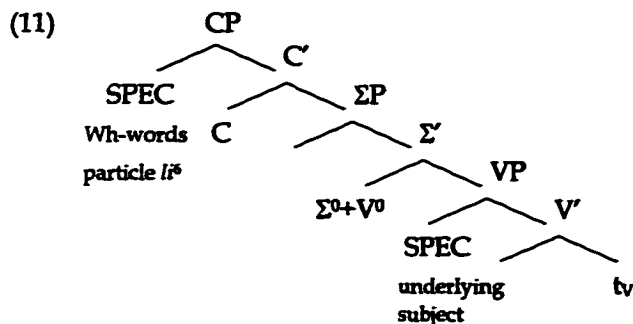

How are the various surface word orders accounted for if they are derived from the structure in (11)? Word orders, according to King, encode specific discourse information; topics precede discourse neutral constituents which in turn precede foci. When the arguments in a clause are discourse neutral, for example in a sentence which opens a discourse, they remain within the VP. This is the case of the discourse-opening *presentational sentences*⁷ (12):

- (12) *Postroila koza izbušku v lesu.*
 built goat-NOM hut-ACC in woods-LOC
 'The goat built a hut in the woods.'

The verb *postroila* 'built' precedes its arguments because it raises to Σ^0 (the tensed verb always raises, not only in presentational sentences) while the subject *koza* 'the goat-NOM' remains in the SPEC, VP and the direct object *izbušku* 'the hut-ACC' remains a complement to the verb. It is well-known that Russian is a strongly discourse-oriented language, where given information (theme, topic) typically precedes new information (Rheme, focus). This discourse orientation, and the fact that there are no special morphological markings for discourse functions in Russian, give King reason to believe that arguments move out of their D-structure positions into various discourse-specific S-structure positions for the purposes of receiving discourse function interpretations. The proposed movements, which are not distinguished in terms of A'- or A-

⁶ King shows that typically, the particle *li* 'whether' is a syntactic clitic that is adjacent to the phrase being questioned in a yes-no question. If this phrase raises to SPEC, CP, *li* follows it and appears on the surface in the second position.

⁷ Bailyn (1995) refers to presentational sentences as *zero-Theme sentences*, and Junghanns and Zybatow (1995) call them *thetic sentences*.

movement, can be of the following types: 1) left-adjunction of internal topics to ΣP ; 2) right-adjunction of foci to VP; 3) substitution into the SPEC, ΣP for contrastive focus, and 4) left-dislocation of external topics.

Topic is loosely defined as what the sentence is about, the equivalent of “old information” (Theme). Only constituents that are maximal projections can topicalize⁸. King classifies Russian topics into two types, *external* and *internal*. External topics, as in (13b), are base-generated in a special CP-adjoined position, are always in the NOM case, are coreferent with a resumptive pronoun in the clause, and there can be only one external topic per clause. Internal topics, on the other hand, are always arguments of the verb bearing a particular case-marking and move from their VP-internal D-Structure position to adjoin to the ΣP , lower than CP. There are sentences without topics (presentational sentences (12)), and sentences with multiple (internal) topics (13a). External topics can only occur in root clauses, while internal ones occur in both root and subordinate clauses (13b):

- (13) a. [Ivan]_T [mne]_T prislal pis'mo.
 Ivan-NOM me-DAT sent letter-ACC
 'Ivan-TOP sent me-TOP a letter.'
- b. [Škola₁]_{Ex.Topic} kakaja ona₁?
 school-NOM, what it
 'The school-TOP, what is it all about?'

In non-interrogative sentences, by virtue of their landing site locations (see the structure in (11) above), topics are always sentence-initial. According to King, this movement is the only way to encode the discourse function of topic in Russian. If the argument remains within the VP, it cannot be interpreted as topic.

Focus corresponds roughly to the traditional notion of “new information” (Rheme). In Russian, focus can be encoded in many ways: word order change, stress assignment, *éto* clefting,

⁸ In King's presentation, a phrase is designated as a (internal) topic according to the discourse requirements. It then has to move out of its D-structure position to the topic position. In that sense, being a topic and topicalizing are identical terms.

asking a *li* yes-no question, and morphological particles. King distinguishes three types of focus: *new-information*, *presentative*, and *contrastive*. New information (14a,b) and presentative focus (14c) are always clause-final. (For notation in these examples and below see footnote 1 above):

- (14) a. [Otec]_T čitaet knigu. NO FOCUS MOVEMENT;
 father-NOM reads book-ACC (NEW INFORMATION FOCUS ON THE DIRECT OBJECT)
 Otec čitaet [KNĪgu]_F TOPICALIZATION
 Otec [čitaet KNĪgu]_F
- b. Čitaet knigu [oTEC]_F RIGHT-ADJUNCTION
 'The father is reading the book.' (NEW INFORMATION FOCUS ON THE SUBJECT)
- c. Postroila koza izbušku v lešu.
 built goat-NOM hut-ACC in woods-LOC
 [Postroila koza izbušku v lešu]_F PRESENTATIVE FOCUS
 'The goat built a hut in the woods.'

King argues that these types of focus (new information and presentative) are characteristic of *non-emotive speech*. In non-emotive speech (sentences with neutral intonation and no sentence stress), topics (old information, the Theme) precede foci (new information, the Rheme). In emotive speech, with expressive intonation and sentence stress, the order of topics and foci may be the opposite, that is, the focus may precede the topics. King refers to this kind of focus as the *contrastive focus*. Contrastive focus is always marked with sentence stress. Since sentence stress marks the contrastively focused constituent, word order per se is no longer important for this purpose. The contrastively focused phrase is usually located immediately before the verb, as in (15a), but it may appear in other positions, as in (15b):

- (15) a. "Evgenija Onegina" [PUŠkin]_{CF} napisal.
 b. [PUŠkin]_{CF} "Evgenija Onegina" napisal.
 'Pushkin-CF wrote *Eugene Onegin*.'

To capture the apparent generalization that the contrastively focused constituent in most cases appears immediately before the verb, King suggests that the contrastive focus is a property of a particular structural position in the Russian clause, namely, the SPEC, ΣP position. Since there is only one such position, one contrastive focus is allowed per clause. The expanded version of the underlying structure of the Russian clause is in (16) (cf. (11)):

(16) (King, 1993): Structure of the Russian Clause

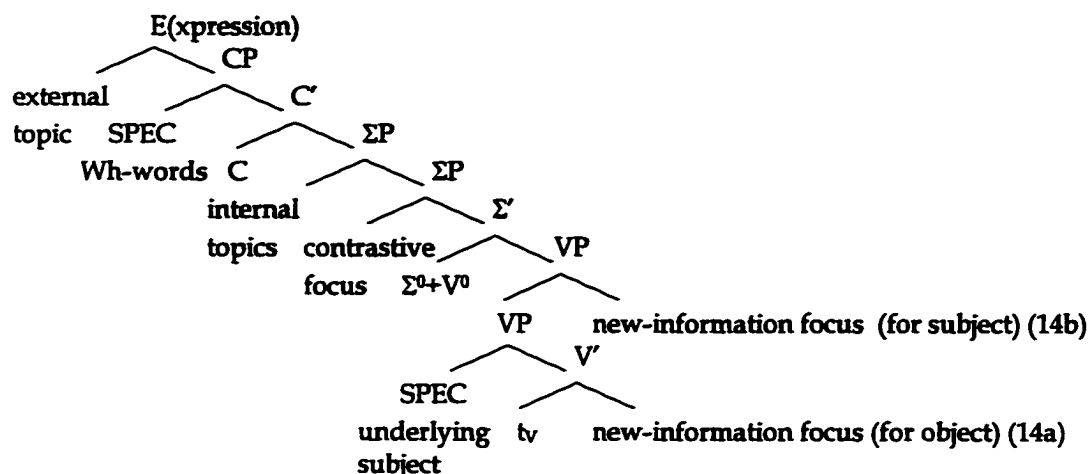

To summarize, King (1993) argues for the canonical VSO order of the Russian clause, where all the arguments originate within the VP out of which they can move. All surface word orders are derived by various movements: V Raising, Right VP-Adjunction of the subject (Neutral Focus), Left IP(ΣP)-Adjunction of any other NP (Topic), and Substitution into SPEC, IP(ΣP) (Contrastive Focus). King does not formulate her generalizations in terms of A'- or A-movement since she is more concerned to identify what motivates them. All movements of arguments out of the VP in Russian result in either topic or focus interpretation. Therefore, the configurational D-structure of the Russian clause encodes the argument structure of the predicate, while the S-structure encodes the grammatical functions, and the final orderings reflect structurally represented discourse functions of topic and focus.

3.3.3 Extraposition, IP- and VP-Adjunction and the Functional Form Hypothesis (Bailyn, 1995)

Bailyn (1995) also argues for the configurational nature of the Russian clause but he proposes a more traditional SVO analysis, shown in (17):

(17) (Bailyn, 1995): Structure of the Russian Clause

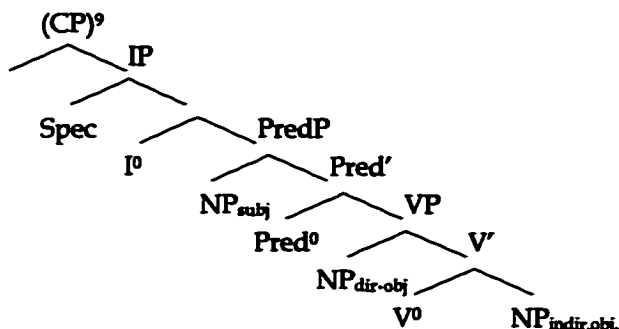

Various surface word orders are derived from the discourse-neutral underlying word order represented by the structure in (17). These derivations are implemented by XP-Scrambling, an instance of Move α which is constrained by the same principles that constrain other movement rules. Bailyn discusses in detail three types of movement that are involved in deriving surface word order variants in Russian: Rightward Adjunction (Extrapolation), Leftward Adjunction (A'-Movement), and A-Movement.

According to Bailyn, there are two types of Extrapolation in Russian which can occur both in root and subordinate clauses: heavy elements can right-extrapolate just like in English, as in (18a)¹⁰, and subjects in certain types of clauses¹¹ can extrapolate, as shown in (18b) for VS intransitives (unergatives):

- (18) a. Ivan pročital t_i synu [pis'mo, kotoroe prišlo po počte]_i.
 Ivan read son-DAT letter-ACC that-ACC came in mail
 'Ivan read to his son the letter that came in the mail.'
- b. Na beregu reki t_i p'jut [stariki]_i.
 On shores river-GEN drink old men-NOM
 'On the shores of the river old men are drinking.'

⁹ According to Bailyn, Russian CPs are found in Wh and yes-no questions, embedded clauses, relative clauses and some Topicalization structures. However, it is not necessary to include them in matrix indicative sentences.

¹⁰ Recall from the discussion in Chapter 2 that Bailyn argues for an underlying order of two objects where DO precedes IO, in contrast to standard assumptions that IO precedes DO.

¹¹ The other two types are surface VS clauses with unaccusative verbs and derived OVS clauses with transitive verbs.

Leftward Adjunction (A'-Movement) is the process that accounts for the vast majority of surface word orders in Russian. Bailyn follows the traditional assumption that XP-Scrambling as Leftward Adjunction adjoins the moved phrase to a higher maximal projection. As Leftward Adjunction, it exhibits properties almost identical to Wh-Movement, a well-studied instance of A'-Movement (see Section 2.3.1 above). Bailyn proposes the following two generalizations (19) describe what are the possible landing sites for adjunction and which constituents can scramble:

(19) Generalization 1: XP-Scrambling in Russian is disallowed as adjunction to arguments (DP, PP, CP).

Generalization 2: 1) Only potential arguments can scramble (NP, PP, CP);
2) [+N] categories (including AP) can scramble.¹²

The final case of XP-Scrambling in Russian is A-Movement, which Bailyn claims is responsible for deriving constructions comparable to English double-object constructions with Dative Shift. Reordering of DAT and ACC arguments within the VP in Russian demonstrates properties of A-Movement, which is possibly realized as VP-adjunction, and it allows A-binding of anaphors, as shown in (20a), though in the absence of such movement, a Principle C violation arises, as illustrated in (20b):

- (20) a. Mama predstavila [Petrovym_i]₁ drug druga_i t₁. SCRAMBLED
mother-NOM introduced the Petrovs-DAT each other-ACC
- b. *Mama predstavila drug druga_i Petrovym_i. UNSCRAMBLED
mother-NOM introduced each other-ACC the Petrovs-DAT
'Mother introduced the Petrovs to each other.'

Thus, Bailyn (1995) identifies the specific instances of movement in Russian as A'- or A-movement following Mahajan's (1990, 1994) and Tada's (1993) proposals about XP-Scrambling as a non-uniform movement which can be either XP-Adjunction (A'-movement), which corresponds to Bailyn's Extraposition and Left IP-Adjunction, or Object Shift (A-movement), which corresponds to Bailyn's object rearrangements in the double-object construction.

¹² Clause 2) in Generalization 2 is needed to account for discontinuous DPs and PPs (see Part II of this dissertation).

Just as for King (1993), the most important question that Bailyn tries to answer is what motivates XP-Scrambling (and Object Shift) in Russian. He adopts the traditional view that in Russian, Theme (given information, Topic) precedes Rheme (new information, Focus) and argues that Theme-Rheme structure is derived by XP-Scrambling, which obeys certain syntactic constraints. Topic is a phrase that has moved to the left-edge of a clause and is IP-adjoined. It binds a [+Case] gap down below in the clause. This can occur both in matrix (21) and embedded clauses:

- (21) [Generalov]_{TI} ja nenavižu t_i.
 generals-ACC I-NOM hate
 'I hate generals.'

The right edge of the Russian clause is a Focus position. Syntactic Focus is achieved by means of a particular word order, intonation, or both, and serves to unambiguously identify an element as Rhematic (new) material. Right Focus is marked by default intonation, which consists of gradually lowering pitch, which falls sharply on the last stressed word of a sentence. In the underlying SVO word order for transitive sentences, objects naturally appear in the sentence-final position and may not be distinguishable as focused in that position. Sentence (22) can be ambiguous between having the direct object focused as in (22a), the entire VP focused as in (22b), and the entire clause focused (22c):

- (22) mal'čik čitaet knigu.
 boy-NOM reads book-ACC
 a. mal'čik čitaet [KN|gu]_F
 b. mal'čik [čitaet KN|gu]_F
 c. [mal'čik čitaet KN|gu]_F
 'The boy is reading a book.'

When a subject, as in (23a), or a verb, as in (23b), occur in the sentence-final position, they become focused, and this is the most common way of focusing these constituents:

- (23) a. Čitaet knigu [MAL'čik]_F
 'It is the boy who is reading the book.'

- b. *Mal'čik knigu [čiT Aet]F*
 'The boy is reading the book.'

Another way of focusing a constituent is to use Left Focus. Left Focus is a more marked construction, being always accompanied by Focus intonation, that is, by heavy stress and interpreted as new information. By being on the left, however, the focused phrase may potentially coincide with the Topic position, which has been identified as the leftmost position in the sentence. While both the topicalized and the focused phrases are left-adjoined to IP, Left Focus in (24a) and Topic in (24b) are distinguished by the presence of the heavy stress on the focused phrase. They also differ by their discourse status: the left-focused phrases *KNigu* 'the book-ACC' and *IA* 'I-NOM' represent new information while topic *generalov* 'generals-ACC' in (24b) is given information:

- (24) a. *[KNigu]LF mal'čik čitaet.*
 book-ACC boy-NOM reads
 'It is the BOOK that the boy is reading.'
- b. *[Generalov]T [IA]LF nenavižu.*
 generals-ACC I-NOM hate
 'It is I who hate generals.'

Left Focus in Bailyn's account of the examples in (24) corresponds to King's contrastive Focus in the examples in (14)¹³.

In summary, Bailyn identifies the two most common ways of focusing material in Russian. First, rightward movement (or keeping the constituent *in situ*) associated with neutral intonation and, second, leftward movement (or keeping the constituent *in situ*) associated with heavy stress (focus intonation). All these movements (XP-Scrambling) that create Topic-Focus structures in Russian obey the usual syntactic constraints applicable to A'- or A-movement. Bailyn concludes that XP-Scrambling in Russian is driven by the tendency to display in the surface syntax certain linguistic relations that in other languages are specified in discourse. He

¹³ For detailed comparison of all three accounts of Russian XP-Scrambling refer to Table 5.

puts forward a hypothesis that surface manifestations of discourse representations can be found at two distinct levels: LF and FF (Functional Form).

Bailyn notes that since surface word order variations in Russian are motivated by logical and functional considerations, instances of XP-Scrambling can be regarded as overt movements deriving FF. Topicalization and Focus Movement, as defined by Bailyn, are not tied to any particular structural positions in a sentence. This stands in contrast with the theory proposed by King (1993). Focus and Topic, in her analysis, are associated with particular syntactic configurations (Section 3.3.2). Bailyn shows, to the contrary, that Topics in Russian can precede or follow a Wh-complementizer, while Focus can be anywhere in the sentence. Therefore, we should allow for Topics to be adjoined not only to IP, but to CP as well. Focus, on the other hand, is associated with intonation and projection, and not a particular configurational slot. Moreover, Left Focus is not necessarily interpreted as Contrastive Focus, in contrast with King's proposal.

Since, according to Bailyn, Focus and Topic in Russian are not assigned to unique configurational slots, it is necessary to encode the partition of a sentence into Topic and Focus domains. This partition is the information represented at the level of FF, where Topic precedes Focus.

To summarize, Bailyn argues that clause-internal XP-Scrambling in Russian is A'-movement in most instances but is A-movement with respect to Object Shift in the double-object construction. However, in contrast to the previous studies of scrambling languages like Japanese, Korean, German, Hindi, and Dutch, Russian A'-Scrambling can be bidirectional, that is, adjunction is either to the right of VP or left of IP. The motivation for XP-Scrambling in Russian is to derive Topic-Focus structure of the Russian clause. This Topic-Focus structure is not tied to particular syntactic slots, which play a crucial role in King's analysis of Russian XP-Scrambling (Section 3.3.2). It is represented at a special abstract level of representation of Functional Form (FF), derived from the surface structure by rules sensitive to word order and intonation.

3.3.4. F-Scrambling vs. N-Scrambling and I-Structure Hypothesis (Kondrashova, 1996)

Kondrashova (1996) proposes a minimalist analysis (Chomsky 1993; 1995) very similar in spirit to Bailyn's (1995) with respect to postulating an independent abstract level at which the distinction between new and given information in Russian is explicitly represented.

She assumes that XP-Scrambling, like any other syntactic operation, should obey the Economy Principle (Chomsky, 1995), and just as for any other syntactic movement, the traces left by XP-Scrambling should be bound by operators. Following Tada (1993), Kondrashova distinguishes three types of XP-Scrambling in Russian, all leftward, depending on the syntactic characteristics of the landing site: S(hort), M(iddle) and L(ong Distance) XP-Scrambling. S-Scrambling consists of permutations of objects in IP, but crucially without crossing the subject. M-Scrambling is movement to a position past the subject within the same clause. L-Scrambling is movement to a position outside the clause. S- and M-Scrambling can take place both in matrix and embedded clauses, all three types can be multiple, and one type of XP-Scrambling can be combined with another in the same sentence. In terms of the landing site problem, Kondrashova argues for the solution proposed by Frank et al. (1992) for German and Korean, according to which XP-Scrambling is a non-operator A'-Movement since it does not establish operator-variable relations. Kondrashova shows that XP-Scrambling does not have either syntactic or semantic motivation. Syntactically, there is no uniquely defined landing site for a scrambled phrase; it basically can adjoin almost anywhere within a clause. Most cases of XP-Scrambling do not introduce any interpretational changes into a sentence because discourse properties (topic and focus) are not included in semantics. It is equally grammatical for a DP to stay *in situ* or scramble. It is not a targeted movement, since nothing forces the scrambled phrase to move from its A-position, and nothing seems to be achieved by moving it into the scrambled position. Thus, it looks as if XP-Scrambling in Russian does not obey the Economy Principle. Should the Economy Principle be abandoned for Russian XP-Scrambling? Kondrashova does not want to accept this.

Instead, she advocates a solution according to which XP-Scrambling is motivated by the principles that apply at a new, abstract level of representation, I-Structure.

I-Structure is a level of representation where discourse principles apply. The main idea behind this proposal is the necessity of distinguishing between new and given information. Kondrashova defines given information (Topic) as predictable, salient, and part of the knowledge shared by the speaker and hearer. New information (Focus) is defined as stressed material. The two principles that apply at I-Structure are the *Discrimination Principle* and the *Alignment Principle*, as shown in (25):

- (25) (a) *Discrimination Principle*: At I-Structure, every element must be F(ocus)- or T(opic)-marked.
 (b) *Alignment Principle*: At I-Structure, T-marked elements must precede F-marked elements in a clause.

The Economy Principle applies at I-Structure, so that the derivation that has the minimal number of covert movements compatible with satisfaction of (25) is allowed and all the others crash.

Kondrashova's analysis of XP-Scrambling in terms of its syntactic nature is very similar to the analysis advocated by Bailyn (1995). The structure of the grammar is as in (26a), as compared to that proposed by Bailyn (1995) (26b):

(26) a. Kondrashova:

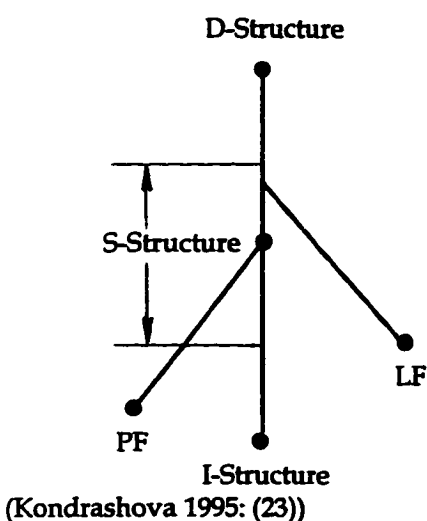

b. Bailyn:

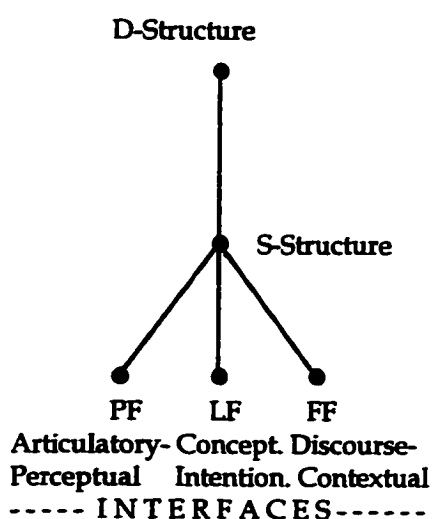

According to Kondrashova, S-Structure is a point in the derivation (26a) at which Spellout takes place.¹⁴ The freer the word order is in a language, the closer S-Structure representations in this language are to their I-Structure representation. S-Structure of scrambling languages is often a version of I-Structure mapped into PF, where XP-Scrambling is defined as I-Structure movement. Therefore, S-Structure must be able to simultaneously satisfy I-Structure principles and be mapped into LF to satisfy semantic principles.¹⁵ In contrast, in Bailyn's analysis, FF constitutes a third point of interface (the other two being PF and LF) between the human linguistic system and the non-linguistic portions of the mind.¹⁶

How does a syntactic derivation of a sentence proceed in Kondrashova's system? The facts analyzed are the same as in King's (1993) and Bailyn's (1995) accounts, but the mechanism is different. A pitch accent in the intonation contour marks particular material that has new information status in a sentence, as focused [+F]. The movement of an F-marked element is defined as *F(ocus)-Scrambling*. Elements that have given-information status get T(opic)-marked and are subject to a different type of XP-Scrambling, *N(eutral)-Scrambling*. F-scrambled elements differ from N-scrambled elements with respect to pitch accent: F-scrambled elements bear a pitch accent, and N-scrambled ones do not.

F-Scrambling seems to present a problem for the Economy Principle: why move the F-marked constituent at all if it is more economical to leave it *in situ*? The explanation comes from the fact that F-Scrambling has a motivation different from N-Scrambling and can, but does not have to be, an I-Structure-building movement at all. Focus is not only a syntactic and semantic

¹⁴ "... starting from a certain point, the derivation takes two different courses: one to build the I-structure, the other to build the LF. ... I place the LF/I-structure bifurcation in the middle of the derivational path, before I-structure movements come into play. As for PF, I assume that since PF rules apply to S-structure, the PF level forks off at whatever point in the derivation the Spellout occurs, so that PF is floating together with S-structure". (Kondrashova 1995, pp. 123-124)

¹⁵ Kondrashova, like Bailyn (1995), argues that the two levels of representation in her system, LF and I-Structure, can have incompatible properties and thus each is independently needed (see Kondrashova (1996), Chapter 3).

¹⁶ Bailyn's (1995) dissertation and Kondrashova's (1996) dissertation, despite the actual difference in dates, appeared simultaneously, and, therefore, neither of the authors responded to the other proposal.

- c. Kolja_t poslal [Maše]_T [pis'MO]_F I-STRUCTURE
 Kolja-NOM sent Masha-DAT LETTER-ACC
 'Kolja sent a letter to Masha.'

In (28b), the objects have their statuses reversed – *pis'MO* 'letter-ACC' is defined as new information and *Maše* 'Masha-DAT' as given information. *Pis'MO* 'letter-ACC' receives F-marking (Constituent Focus) and can now undergo F-Scrambling. It does not need to move, since it is already in the default sentence-final focus position. T-marked material, *Maše* 'Masha-DAT', also does not undergo N-Scrambling. However, notice that now the structure in (28b) violates I-Structure's Alignment Principle, since the F-marked element precedes the T-marked element. In order to satisfy it, the scrambled *pis'MO* 'letter-ACC' covertly, at I-Structure, moves to the sentence-final position (28c). Thus, XP-Scrambling is driven by the information status of arguments: phrases with new information status are focused and undergo F-Scrambling, while phrases with given information status are topics and undergo N-Scrambling.

Since XP-Scrambling is an adjunction operation, pitch accent on the adjoined scrambled phrase is not allowed to project. The direct object *pis'MO* 'letter-ACC' in (28a) cannot be interpreted as Constituent-focused in this position, because it is always possible to project Focus from the object all the way to include the entire sentence. The only way to ensure that it gets a Constituent Focus is to scramble it. Then it will receive a Constituent Focus, which cannot project. T-marked arguments may N-scramble to avoid being included into the Focus. When adjoined, N-scrambled elements interrupt Focus projection. Thus, both F-Scrambling and N-Scrambling can be motivated by interpretational considerations related to Focus formation. Focus is an I-Structure phenomenon, since word orders produced by Focus formation are consistent with I-Structure principles, but are incompatible with the semantic principles that govern formation of quantificational domains at LF.

3.3.5 Information-Structure (Junghanns and Zybatow, 1995)

Junghanns and Zybatow (1995) (like King (1993) and Bailyn (1995)) consider Russian a configurational language and propose an articulated structure of the Russian clause with multiple functional projections. The surface word orders are derived by a series of overt movements. Except in zero-thetic sentences, the subject raises to SPEC, Agr_SP, and the verb to Agr_S. The movement of the subject is motivated by the discourse situation – it raises when it has already been introduced in the discourse. Overt raising of the object occurs for the purposes of (contrastive) Topicalization, as shown in (29):

- (29) Gazetu_i Ivan čitaet t_i.
 newspaper-ACC Ivan-NOM reads
 'It is the newspaper that Ivan is reading.' (Junghanns and Zybatow 1995: (17))

Examples like (29) show that subject and object (as well as the verb) in Russian can move out of their base positions. However, such movements are optional since overt morphology does not render them necessary. Junghanns and Zybatow claim that overt movement is induced by requirements of a special abstract level of representation, *Information Structure (IS)*.

This level seems to be very similar to the Functional Form advocated by Bailyn (1995) and the I-Structure proposed by Kondrashova (1996). IS refers to the surface order of elements in the clause, which reflects the communicative situation. IS has two dimensions, that is, there are two ways of partitioning IS: *Focus-Background Structure (FBS)* and *Topic-Comment Structure (TCS)*. At FBS, a constituent that conveys new information is singled out, while at TCS, a constituent that the clause is about is prominent. Example (30) illustrates the two dimensions of IS:

- (30) - Kto tebe podaril kol'co? - Kol'co mne podaril Ivan.
 who-NOM you-DAT gave the ring-ACC ring-ACC me-DAT gave Ivan-NOM
 'Who gave you the ring?' 'It was Ivan who gave me the ring.'
- background focus
FBS: [Kol'co mne podaril] [Ivan]
 topic comment
TCS: [Kol'co] [mne podaril Ivan]

Junghanns and Zybatow make the following two assumptions about the IS of Russian clauses:

- (31) 1. Constituents move out of the VP only if required to by their discourse functions;
 2. Certain syntactic positions are associated with particular discourse functions.
 (Different types of topics and foci are syntactically and phonologically encoded in different ways.)

Important aspects of the sentence characteristics in Russian represented at IS include neutral sentence stress (neutral focus), contrastive stress (contrastive focus), and overt movement of constituents. All three factors can overlap in a sentence, and this is responsible for multiple possible IS representations. The neutral focus is the so-called New Information Focus, which can be either minimal or non-minimal, that is, it can project higher up in the clause (to include the VP, or the entire CP). Thus, the focus exponent, the syllable carrying the main stress, carries the focus feature [+F] and can be associated with different syntactic domains. Junghanns and Zybatow assume that this focus feature [F] is purely syntactic and is realized via free assignment to any constituent in the syntactic tree. The pragmatic function of [F] is to emphasize the information that is important in the given context. The constituent associated with the topic feature must move to the topic position. The topic position in the Russian clause is the position adjoined to AgrsP.

Continuing the discussion on the discourse nature of the postverbal subject started by King (1993) and Bailyn (1995), Junghanns and Zybatow also address this issue. They discuss two potential solutions: VP-Evacuation and Right Adjunction. VP-Evacuation can be motivated by the necessity for material which does not belong to the focus to move out of the VP, which (provided there is neutral focus in the sentence) always gets the [F] feature. The subject will remain within the VP and its stressed syllable will be the focus exponent. This solution is adopted by Kondrashova (1996). Right Adjunction means that a narrowly focused subject moves out of the VP and right-adjoints to it, a solution argued by both King (1993) and Bailyn (1995). Junghanns and Zybatow show that major problems for minimality arise for the VP-Evacuation

hypothesis, when the sentence contains more lexical material than just subject, verb, and object, and so they adopt the Right Adjunction hypothesis for the postverbal subjects.

Recall that the neutral focus is only one type of possible focus in Russian. The second one is the *Contrastive Focus*, which in contrast to the New Information (neutral) Focus has emphatic meaning indicating a contrast with other potential answers. Contrastive Focus always correlates with contrastive stress and can focus any constituent *in situ* or after movement. Since the Contrastive Focus is realized by means of a syntactic feature with corresponding phonological and semantic consequences, it is not bound to a particular position. This view is in contrast with King's (1993) theory, according to which the SPEC position of a particular functional projection (ΣP) is the unique syntactic position for Russian Contrastive Focus.

To sum up: Junghanns and Zybatow's analysis of word order variation in Russian is not as detailed as either of the first three proposals, King (1993), Bailyn (1995), and Kondrashova (1996). Assuming the configurational character of the Russian clause, they adopt a Split-Infl hypothesis for Russian and the VP-internal subject position which allow overt movements of constituents in the clause. Junghanns and Zybatow, however, do not discuss the syntactic nature of such movements. They strive to find a motivation for them which comes from discourse requirements to be fulfilled at the level of Information-Structure. In contrast to the other three proposals, they claim that Topic and Focus each has its own partition at IS. Note that all four discourse-function analyses are highly comparable to each other:

Table 4. Comparison of the Four Approaches to Discourse-Relevant Status of Constituents

	DISCOURSE-RELEVANT STATUS OF CONSTITUENTS		
KING (1993)	Topic	- discourse-neutral material	- Focus
BAILYN (1995)	Topic	----- X -----	- Focus
KONDRASHOVA (1996)	Topic	----- X -----	- Focus
JUNGHANNS AND ZYBATOW (1995)	Topic	----- Comment	
		Background -----	- Focus

There is always Topic that precedes Focus, which can be separated by some neutral material X, most typically the verb. Topic moves out of the VP and adjoins to the left of some higher functional projection in the expanded IP. Focus can be of two types: Sentential (wide, default) and Constituent (narrow, contrastive). While sentential Focus is assigned on the right edge of the clause to a constituent *in situ*, constituent Focus can be assigned either to any constituent *in situ* with the help of special intonation and stress, or via movement of this constituent to a right-adjoined VP-position.

Topic and Focus movements can happen either at S-Structure or at an abstract level of Functional Form (I-Structure, Information-Structure). At S-Structure, these instances of movement are mostly adjunctions (with possible exception of the double-object construction), which makes them A'-movements. These movements can also occur at FF. FF-movements are not defined with respect to their A'-/A-properties because this distinction is not relevant at the FF level. The crucial point is their driving force. Since the driving force behind Topic and Focus movement is discourse requirements, which are satisfied at FF, Topic and Focus movements are defined as discourse-motivated XP-Scrambling, which is presented as an argument in favor of the level of Functional Form.

3.3.6 Summary

In order to understand the relationships among the different proposals described in sections 3.3.2 to 3.3.5, I present here in Table 5 a concise comparison of the four functional approaches to XP-Scrambling in Russian:

Table 5. Comparison of the Four Functional Approaches to Word Order Variations in Russian

	KING (1993)	BAILYN (1995)	KONDRASHOVA (1996)	JUNGHANNS AND ZYBATOW (1995)
Configurationality	VSO	SVO	SVO	SVO
Relevant Functional Projections	Σ P	PredP		AspP, AgroP, CP, NegP, TP, AgrsP
Position of Subject	SPEC, VP	SPEC, PredP	SPEC, VP	SPEC, VP
Verb Raising	$V^0 \rightarrow I^0$	$V^0 \rightarrow \text{Pred}^0$		$V \rightarrow \text{Agrs}^0$
XP-Scrambling as Movement	1) Right VP-Adjunction 2) Left Σ P-Adjunction 3) Substitution into SPEC, Σ P	1) Rightward VP-Adjunction 2) A'-Movement IP-Adjunction 3) A-Movement =left VP-Adjunction	1) S-Scrambling =A-Movement 2) M-Scrambling = A' or A-Movement 3) L-Scrambling =A'-Movement	
XP-Scrambling types		1) Focus Mov-t 2) Topicalization	1) F-Scrambling. 2) N-Scrambling	
Focus types	1) new info.2) presentational contrastive	1) Right Focus = new information 2) Left Focus	1) Sentential Focus 2) Constituent Focus	1) new information 2) contrastive
Focus position: new info focus;	right-edge of the clause - <i>in situ</i> ;	right-edge of the clause - <i>in situ</i> ;	right-edge of the clause - <i>in situ</i> ;	right-edge of the clause - <i>in situ</i> ;
Focus position: Theme sentences	0- right VP-adjunction	right VP-adjunction	Left movement of constituents	right VP-adjunction
Focus position: Contrastive focus	SPEC, Σ P	anywhere in the clause		anywhere in the clause
Focus and Intonation (Stress)		1) Basic Focus 2) Stress Focus 3) Phrasal Focus	1) Basic Focus 2) Constituent F 3) Projection of F	
Special level of representation	none	Functional Structure (FF)	I-Structure	Information-Structure (IS)
Motivation for XP-Scrambling	Discourse functions associated with unique S-Struct. positions	to derive FF	to derive I-Structure; to disambiguate Focus ambiguities	to derive IS; to disambiguate Focus ambiguities
Rules/Principles of special level	none	"Generalized Tree Splitting": Topic Raising Focus Raising	Discrimination Principle Alignment Principle	2 dimensions: Focus-Background Topic-Comment

King (1993) argues that word order in Russian directly, i.e., syntactically, encodes the discourse functions of topic and focus. In the unmarked case, initial elements are topics, they are followed by discourse-neutral information, and final elements are foci, resulting in typical SVO word order. Multiple topics and foci are allowed and are even quite frequent. Topics move out of the VP and adjoin to the ΣP . New-information focus usually occurs at the right-edge of the clause and can project all the way to include the entire clause. A contrastively focused phrase moves out of the VP into the SPEC, ΣP . Presentational focus is used in so-called presentational sentences with no topics, and the subject in such sentences stays *in situ* while the verb moves above it, and this results in the presentational VSO word order. King does not provide any explanation about how particular phrases get marked as topics and foci. She assumes that these functions are provided by the discourse circumstances, and the goal of syntax is to syntactically realize them, since Russian is one of the languages that bears its discourse-orientation on its sleeve.

Bailyn (1995), Kondrashova (1996), and Junghanns and Zybatow (1995) all argue against King's proposal, that discourse functions are associated with unique syntactic positions in the Russian clause. And if they are not, then the conclusion is that S-Structure is not the right representation for discourse functions. For these purposes, an additional abstract level of representation is required¹⁷, *Functional Form (FF)* (Bailyn, 1995), *I-Structure* (Kondrashova, 1996), *Information-Structure* (Junghanns and Zybatow, 1995), which is necessary to uniquely encode these functions and to disambiguate possible functional representations of a Russian sentence. A particular functional structure of the clause, marked by intonational means, is derived by moving topics and foci via XP-Scrambling. XP-Scrambling may remove a particular phrase out of the scope of focus by moving it to a position outside the VP. On the other hand, intonation may mark the same phrase with special pitch, which will allow or disallow a certain functional

¹⁷ A similar proposal is advocated by Erteschik-Shir (1993) in her manuscript *Dynamics of Focus Structure* based primarily on data from English and Hebrew. She argues for a universal abstract level of *Focus Structure*.

interpretation. At FF/I-Structure, phrases marked as [+topic] must precede phrases marked as [+focus]. If XP-Scrambling has already done the job by providing a legitimate order (topics precede foci), the FF/I-Structure of the sentence will coincide with its S-Structure. If not, covert movement at FF/I-Structure will ensure that topics precede foci (see Section 1.3 above for discussion).

While Bailyn and Kondrashova discuss at length the differences between FF/I-Structure and LF, showing that both are independently needed, they do not address the relationship between PF and FF/I-Structure (nor do Junghanns and Zybatow, 1995) or whether one is reducible to another. However, in contrast to King's theory, both Bailyn and Kondrashova try to show how the topic/focus distinction is realized at FF by using Selkirk's (1995) theory of focus.

3.4 XP-Scrambling in Russian and the Syntax-Phonology Interface

In Section 3.2, we have reviewed Reinhart's (1995) arguments in favor of XP-Scrambling as driven by Focus requirements. This analysis becomes especially attractive when applied to languages like Russian which are traditionally known to have discourse-oriented 'free' word order. In Section 3.3, it has been shown that recent studies of XP-Scrambling in Russian (King, 1993; Bailyn, 1995; Kondrashova, 1996; Junghanns and Zybatow, 1995) pay special attention to the question of its motivation, an important issue within the Minimalist program. These analyses can be identified as a discourse-function approach to XP-Scrambling because they are less concerned with the issue of the structural characteristics of XP-Scrambling in Russian than with its motivation. Relying heavily on already well-established facts in functional grammar (for instance, Yokoyama, 1982), particularly notions of new/given, and combining them with formal GB principles, these analyses attempt to link word order variation in Russian with the Topic/Focus distinction, a relatively new field of interest in current generative grammar. Topic and Focus movements in Russian are argued to be driven by the necessity to satisfy a principle of

organization of discourse in Russian, according to which Topic precedes Focus. Within the discourse-function approaches, this principle is presumed to operate at a special abstract level of representation, Functional Form (FF) (a.k.a I-Structure, Information-Structure), for the existence of which the authors propose various arguments.

The introduction of a new level of representation is a serious step in the modification of the current linguistic theory, and it has not yet been shown convincingly whether FF is necessary. Reinhart's (1995) theory makes it possible to investigate an alternative to this modification, that is, a syntax-phonology interface analysis of XP-Scrambling. In the present Section 3.4 I will present an attempt to describe XP-Scrambling in Russian in terms of Reinhart's analysis of a syntax-phonology interface, an alternative to the four functional analyses of Russian XP-Scrambling as FF movement.

As has been argued in Chapter 2, freedom of XP-Scrambling in Russian is considerable.¹⁸ It is very difficult to find examples of ungrammatical XP-Scrambling, other than those exhibiting unacceptable ambiguity or violating a particular grammatical constraint such as binding and bounding constraints. However, among possible word orders for a particular sentence, there is a sort of hierarchy of choices according to which some are better and some are worse. Investigation of the factors relevant to the acceptability or naturalness of XP-Scrambling goes well beyond that of syntax. These factors concern the communicative structure of the Russian clause, that is, its focus structure which encodes specific discourse functions. Under normal circumstances, Topic (Theme) usually precedes focus (Rheme) in neutral speech (32):

- (32) a. Zero context: the opening sentence of the discourse:
- | | | |
|------|---------------------------------------|---------|
| (i) | Ja slyšal, čto uexal [<u>Ivan</u>]. | MARKED |
| | I heard that left Ivan-F | |
| (ii) | Ja slyšal, čto Ivan [<u>uExal</u>]. | NEUTRAL |
| | I heard that Ivan left-F | |

¹⁸ The situation is further complicated by the fact that despite the rich morphological system, there are no special markings on topic and focus in Russian, as is the case in some other languages. There is no morpheme which indicates topicalized constituents. Also, no visible syntactic changes (such as V2 in Hungarian) are triggered by XP-Scrambling.

b. Context:

(i) A: Ivan vse sidit v otkaznikax. OVIR ne daet emu pasporta.
Ivan is still a “refusnik”. The OVIR does not give him his passport.

(ii) B: A ja slyšal, čto [uExal] Ivan. CONTRASTIVE
But I heard that left-CF Ivan

Since the context is zero in (32a), the unmarked word order, SVO, is overwhelmingly preferred. Felicitous use of the proper name presupposes that *Ivan* has the status of given information and so it should precede new information, the fact that he left, as in (32a(ii)). This restriction is violated in (32a(i)), thus rendering the sentence odd with neutral intonation. It is not ungrammatical, however. Proper context (32b) makes it perfectly acceptable: *uexal* ‘left’ receives a contrastive interpretation.

In this chapter, I propose to examine the focus structure of a sentence as encoded at the syntax-phonology interface, where focus structure is understood broadly along the lines of Reinhart (1995). I will consider how this structure is defined by intonation and stress patterns, and how focus considerations motivate XP-Scrambling. Discourse circumstances require each sentence to have a particular focus structure since focusless sentences are prohibited. The Focus structure of a sentence is represented at the syntax-phonology interface, “an enriched PF”, according to Reinhart’s terminology. It is enriched in the sense that the syntactic tree is augmented with certain segmental and prosodic features. Although Reinhart does not state this overtly, I understand the enriched PF as being able to capture such phenomena as sandhi, timing differences, pitch resetting, etc.

Such prosodic features as [-SS] and [+CS] introduced in this section will be a part of the focus structure of a sentence with Scrambling; the [-SS] feature can be associated with one or more phrases, in the case of multiple Scrambling. Particular applications of XP-Scrambling are triggered by the necessity to check off this feature. At the enriched PF, this feature can be instantiated as [-sentential stress] since prosodic means are argued to be a part of it. It is a strong feature and it will require an overt movement in the syntax. The goal of XP-Scrambling is

understood as an operation which takes one or more [-SS] phrases and removes them from the domain of default Sentential Focus. Scrambled phrases land in IP- (or VP-)adjoined positions which block projection of Sentential Focus. The remaining part of the sentence will receive default Sentential Focus through the Generalized Stress Rule, with the most embedded constituent bearing [+sentential stress] and it will have a gradually falling intonational contour. Thus, the only function of XP-Scrambling is to de-focus a phrase; this operation cannot be achieved by prosodic means (which can only assign stress but not remove it). This fact explains frequent combination of XP-Scrambling and prosody in assigning focus structure in Russian.

Under special circumstances, discourse may require a particular constituent to have a Constituent Focus interpretation, which can but does not have to be contrastive. The process of assigning Constituent Focus represented by the feature [+CS] is independent of XP-Scrambling. Note that this feature, in contrast to [-SS], has to be weak otherwise it would trigger overt movement as well, contrary to empirical facts. Since the feature [+CS] can be assigned anywhere in the sentence including the scrambled phrase itself, Constituent Focus can be assigned to any phrase in a sentence. That phrase will be marked with special stress, will have its own separate intonational contour and will have a pause after it.

Consider now how a focus structure can be assigned to a typical Russian unscrambled SVO sentence given in (33). According to the Generalized Stress Rule adopted by Reinhart from Cinque (1993), the most embedded constituent in the clause will receive the default sentential stress. In Russian which, like English, is a right-branching language, the most embedded constituent in a SVO configuration (without adverbs, etc.) is the object:

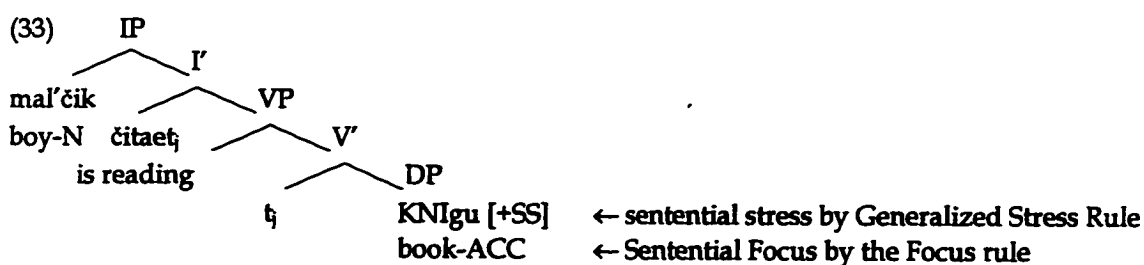

'The boy is reading [the BOOK]-SF.'

The set of possible (sentential) foci in the clause, as argued by Reinhart, is determined by its sentential stress. The stress is determined cyclically by assigning at each new cycle the main stress based on the assignment from the previous cycle (34a), and the Focus Rule (see Section 3.2 above) allows each of these constituents to serve as the Focus (34b):

(34) a.	Mal'čik boy-NOM <u>[mal'čik[čitaet</u>	čitaet is reading <u>[knigu]]]</u>	knigu book-ACC	b. RESULTING F-STRUCTURES:
1. word stress:	[*	[*	[*]]	
2. DP cycle:	[[[*]]	<u>mal'čik čitaet[KN]igu]</u>
3. VP cycle:	[[*]]	<u>mal'čik [čitaet KN]igu]</u>
4. IP cycle:	[*]	<u>[mal'čik čitaet KN]igu]</u>

Reinhart notes that Cinque, in his theory of stress assignment, does not count subject as a constituent which should be included in the extended focus projection; he suggests that the subject possibly constitutes a separate cycle. Reinhart is tentative about this point, speculating that adjoined constituents and constituents in SPEC positions probably are not included in the F-projection. In (34) and (35) below, the subject *mal'čik* 'the boy-NOM' is not included in the F-projection. This is consistent with empirical data from other languages.

Because of the possibility of projecting focus up, the sentence in (33)-(34) is functionally ambiguous, as argued by King, Bailyn, Kondrashova, and Junghanns and Zybatow. That is, with the sentential stress on the direct object *KNigu* 'the BOOK-ACC', it can be uttered in any of the three following contexts (35):

(35) a.	Čto proisxodit? - what is happening?	– <u>[Mal'čik čitaet KN]igu].</u> <u>[The boy is reading the BOOK]-SF</u>
b.	Čto delaet mal'čik? What is the boy doing?	– Mal'čik <u>[čitaet KN]igu].</u> The boy <u>[is reading the BOOK]-SF</u>
c.	Čto čitaet mal'čik? what is the boy reading?	– Mal'čik čitaet <u>[KN]igu].</u> The boy is reading <u>[the BOOK]-SF</u>

A theory along the lines proposed by Bailyn, Kondrashova, and Junghanns and Zybatow requires the FF/I-Structure level to represent the three different possible focus structures

assigned to this sentence. However, for Reinhart, it is not necessary to have a special level of representation to account for this functional ambiguity. At the syntax-phonology interface, the S-Structure, with its full syntactic tree, is enriched with the relevant elements of the phonological structure, such as main stress and necessary prosodic features (36):

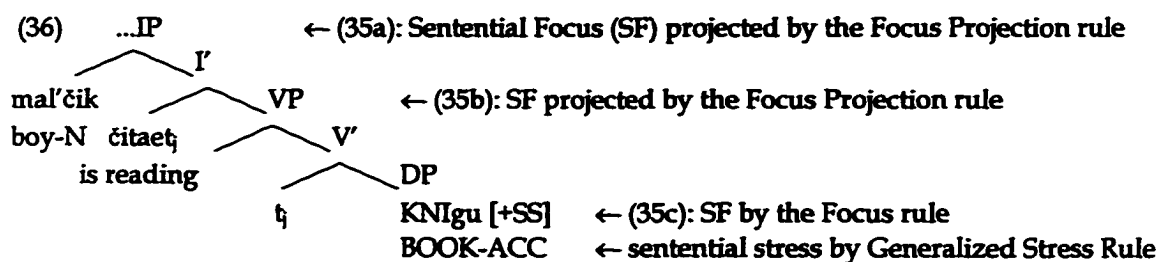

The Focus rule, which relates stress and syntactic structures to focus, applies at the syntax-phonology interface, where it associates a set of possible foci (35a-c) with each “enriched” PF representation (36). Reinhart did not provide a formal notation for representing this enriched PF. I use (36) just as a convenient way of illustrating her general ideas ((36) is, in fact, three separate PF-representations collapsed together, representing (35a-c)). Via the notion of focus, sentential stress interfaces with the theory of discourse. The sentential stress assigned by PF enables sentence (33) to be used in a variety of contexts, since it permits a broad set of possible foci {IP, VP, DO}, as in (35), from which the context can select the appropriate one. Note that I set aside here questions about what the restrictions are on possible focus selection and which focus selection is appropriate for which discourse. For present purposes what is important is that if the functional ambiguity of structures like (35) at the enriched PF is disambiguated with the help of the theory of discourse, and each structure is associated with a unique PF, as in (36), one reason for postulating the FF/I-Structure does not exist any more. Reinhart’s theory makes it possible to unify XP-Scrambling and intonational means of assigning the focus structure to a sentence, without resorting to this special additional level.

The second reason that has been given for positing the FF/I-Structure as a separate abstract level of representation is to account for the standard requirement in Russian that topics (given material) precede foci (new material) in the sentence. To make this so at S-Structure may

be the purpose of XP-Scrambling, as these authors claim. However, in cases where XP-Scrambling is not used, but intonational means are used instead, covert movement at the FF/I-Structure level is called for in order to fulfill this discourse requirement. For example, in Bailyn's (1995) theory (see Section 3.3.3 above), there are two movement rules that operate at the level of FF: Focus Raising and Topic Raising. Focus Raising requires all material marked [+F] to adjoin to PredP, and the Topic Raising rule adjoins all the material marked with [+T] to IP. These rules operate just in case there is no overt XP-Scrambling in a particular sentence, but where Focus precedes Topic in violation of the principle that topics precede foci. This principle holds in most languages (but not all; see Mithun and Miller (1996) on Mohawk). Similarly, Kondrashova (1996) (see Section 3.3.4) proposes the movement rules of N- and F-Scrambling, which can operate overtly at S-Structure, or covertly at I-Structure. In order for T-marked elements to precede F-marked elements, particular constituents may undergo movement at I-Structure to create the proper order of T- and F-marked constituents (see example (28b), Section 3.3.4 for details). Note that covert movement in these theories happens only when topic and focus are marked with special intonation. Since Reinhart's theory unifies XP-Scrambling and intonational means of assigning the focus structure to a sentence, no covert movement is necessary. Intonational means of assigning focus is reflected in special stress [+CS] on a phrase in the sentence. The process of assigning feature [+CS] is a separate process driven by discourse circumstances in which the sentence occurs, and any phrase can carry this feature resulting in Constituent Focus. Thus, the example described in (33)-(36), can have additional, Constituent Focus structures, shown in (37):

- (37) a. Mal'čik čitaet [**KN**Igu].
 'The boy is reading the **BOOK**[+CS].'
 'It is the book that the boy is reading.'
- b. Mal'čik [**č**iTAet] knigu.
 'The boy is **READING**[+CS] the book.'
 'What the boy is doing, he is reading the book.'
- c. [**MAL'**čik] čitaet knigu.
 'The **BOY**[+CS] is reading the book.'
 'It is the boy who is reading the book.'

How is Focus structure assigned to sentences with XP-Scrambling? In order for the object in (33)–(36) to receive Focus, the object can remain *in situ*. The verb and the subject cannot receive sentential Focus independent from the object. They can only be included into the domain of sentential Focus by projection. Suppose discourse circumstances require one of them to be focused. There are two equal ways to achieve this, by XP-Scrambling the object and by assignment of Constituent Focus. If the object is removed by XP-Scrambling out of the VP and adjoined to IP (or VP), the verb becomes the most embedded constituent and it will receive sentential Focus, as shown in (38a, b). That is, in order to obtain Focus on the verb, we de-focus the object. Employing the mechanism of movement, a scrambled phrase with the feature [-SS] is moved into one of the possible landing sites, IP-adjunction in (38a), or VP-adjunction in (38b):

- (38) a.
-
- ← SF projected by the Focus Projection rule
- knigu₁ [-SS] mal'čik čiT Aet [+SS] t₁
- book-A boy-NOM is READING
- SF by Focus Rule → čiT Aet [+SS] t₁
- (i) Knigu mal'čik [čiT Aet].
lit. 'the book the boy is READING [+SS].'
- (ii) Knigu [mal'čik čiT Aet].
lit. 'the book [the boy is READING] [+SF].'
- b.
-
- mal'čik knigu₁ [-SS] čiT Aet [+SS] t₁
- boy-N book-ACC is READING
- SF by Focus Rule → čiT Aet [+SS] t₁
- Mal'čik knigu [čiT Aet].
lit. 'The boy the book is READING [+SS].'

(38a) is still ambiguous because it will allow two focus structures at PF: one with just the verb as the focused constituent (i), and one including the entire IP (ii). The scrambled object *knigu* 'the book-ACC', however, will not be included, because being adjoined to VP, it is outside the focus projection. In (38b), both the object and the subject are not included in the focus set resulting in a structure which is unambiguous with respect to its focus interpretation: the verb is the only

constituent that can be focused. In this respect, Russian is similar to Dutch, where XP-Scrambling is used to assign focus to a constituent from the set of possible foci which cannot get focused otherwise. This is the case of Dutch sentences with Object Scrambling: the verb receives sentential focus after the object is scrambled. This procedure identifies the main function of XP-Scrambling in both languages – tree-splitting for the purposes of De-Focusing.

What is the formal motivation for XP-Scrambling in examples like (38a-b)? The [-SS] feature is imposed on the object DP *knigu* 'book-ACC', and will trigger overt application of movement. In addition, after XP-Scrambling has changed the focus structure of the sentence by removing a constituent out of the purview of the sentential focus, an independent operation which assigns Constituent Focus can also be performed, if required by discourse.¹⁹ The Marked Focus Rule applies (see Section 3.2.4) to assign special stress [+CS] on a constituent that needs to be Constituent-focused. Note that this feature in contrast to the feature [-SS] is weak and does not trigger an application of XP-Scrambling. The resulting structures will be similar to (37) differing only in having XP-Scrambling of the direct object:

- (39) a. [**KN**Igu] mal'čik čitaet.
 'The **BOOK**[+CS] the boy is reading.'
 'It is the book that the boy is reading.'
- b. Knigu mal'čik [**č**iTAet].
 'The book the boy is **READING**[+CS].'
 'What the boy is doing, he is reading the book.'
- c. Knigu [**MAL'**čik] čitaet.
 'The book the **BOY**[+CS] is reading.'
 'It is the boy who is reading the book.'

The nature of the features [SS] and [CS] is prosodic, so they are PF features. The question then arises why they need to be checked off in the syntax. Reinhart's concept of the enriched PF allows such features to participate in the syntactic derivation because all the relevant prosodic information is represented in the tree at this interface. Stress is assigned pre-syntactically which

¹⁹ Bailyn (1995) refers to constituent focus as Left Focus (Section 3.3.3). Kondrashova (1996) argues that her rule of F-Scrambling applies to phrases to which either sentential or constituent focus is assigned (Section 3.3.4). For Reinhart's notion of constituent focus, see Section 3.2.

allows it to play a crucial role in deriving focus structure.²⁰ Different combinations of the two features will result in four possible options in terms of stress, related to focus assignment:

(40)	[+SS]	[-SS]
[+CS]	a phrase in its D-Structure position which is assigned Constituent Focus	a scrambled phrase which is assigned Constituent Focus SPEC, FP substitution
[-CS]	a phrase in its D-Structure position which is assigned sentential Focus	a scrambled phrase which is not assigned any Focus IP (VP)-adjunction

Note that the account of what motivates XP-Scrambling in Russian presented above differs from Reinhart's theory of Scrambling as driven by Focus requirements in Dutch in one aspect. According to Reinhart, Scrambling not only can serve the purposes of de-focusing, but can also be used to move a constituent to a position where it will receive Constituent Focus. She suggests that assignment of Constituent Focus can be a matter of cross-linguistic variation. In her account of narrowly focused subjects, she notes that English resorts to intonation and stress, while Italian, which permits some limited word order variation and right-extraposition of subject, achieves the same goal by movement (see (7), Section 3.2 above). To allow both ways of assigning constituent focus, XP-Scrambling and relocation of the main stress without movement, would go against economy considerations unless each of these means is the only way to achieve a particular interface goal. In the case of Russian, as I have suggested, XP-Scrambling is used only for the purposes of de-focusing, i.e., removing a constituent from the domain of sentential Focus. Assigning of Constituent Focus is an independent operation separate from Scrambling.

The hypothesis that XP-Scrambling is used as a tree-splitting operation for the purposes of de-focusing makes some predictions. For example, application of XP-Scrambling in sentences where the entire clause should be included in the domain of sentential Focus such as the

²⁰ This is the rule ordering problem. If stress applies before movement, it will always give the same structure. But for movement to apply first, it must be driven by Focus. Essentially, it is possible that what is involved is simultaneous satisfaction of multiple constraints.

presentational sentences (41a) (see Section 3.3) should result in a pragmatically odd structure (41b). This is the case.

- (41) a. Odnazdy vesnoju, v čas nebyvalo žarkogo zakata, v Moskve,
 once in the spring at the hour unbelievable hot sunset in Moscow
 na Patriaršix prudax, pojavilis' dva graždanina.
 at Patriarch Ponds appeared two men
- b. ?Odnazdy vesnoju, ... dva graždanina pojavilis'.
 once in the spring two men appeared.
 'Once in the spring at the hour of the unbelievably hot sunset two men appeared
 at the Patriarch Ponds in Moscow.'

The same should also hold for sentences in neutral or zero context (see (32) above). In addition, intonation is not available in the written form, and the speaker has to rely exclusively on word order to assign a focus structure to a written sentence. Finally, derivation of Split Scrambling constructions which are the main topic of Part II of this dissertation, proceeds through XP-Scrambling as the first step, and such constructions obligatorily have Constituent Focus.

3.5 Summary of Chapter 3

This chapter has addressed the issue of discourse properties of XP-Scrambling in Russian. Discourse circumstances impose a particular Focus structure on a sentence. Typically, a sentence can have one of two types of foci: default Sentential Focus or narrow Constituent Focus. Focusless sentences are prohibited. Focus structure of a sentence depends on its prosodic characteristics: the most deeply embedded constituent receives the main sentential stress [+SS] by default, and the Basic Focus Rule assigns sentential Focus to this constituent. According to the Focus Projection Rule, Focus can project up the syntactic tree resulting in a functionally ambiguous structure in which either (or both) VP and IP are in the domain of the projecting Focus. Besides sentential Focus, a sentence can have a Constituent Focus which is licensed by specific stress [+CS] which can be assigned to any constituent in the sentence, including the one carrying the sentential stress, or a scrambled phrase.

Reinhart (1995) suggested that XP-Scrambling and Focus interact: the object scrambles in Dutch in order to move from the most embedded position, thus making it possible to assign sentential Focus to some other constituent in a sentence, e.g., the verb. The scrambled phrase by virtue of its adjoined landing position creates a barrier for projecting Focus; thus, Dutch sentences with object Scrambling have a special Focus structure. Reinhart argued that XP-Scrambling and Focus can interact because there is an interface, the enriched PF, where both the full syntactic tree and relevant prosodic and segmental phonological features, including [SS] and [CS] are present simultaneously at the same point in the derivation.

In this chapter, it has been proposed that Reinhart's Focus-driven analysis of object Scrambling in Dutch can be applied to XP-Scrambling in Russian. Discourse circumstances may require that a constituent which would receive sentential Focus by default should not be focused. There is only one way to de-focus such a constituent – to scramble it. XP-Scrambling copies it from its D-Structure position in the domain of the sentential Focus, and this operation changes the Focus structure of the sentence. Thus, XP-Scrambling in Russian serves the purpose of tree-splitting since the IP- (or VP-)adjoined scrambled phrase cannot be included in the projecting Focus. This movement is triggered by a feature [-SS] on the phrase which undergoes XP-Scrambling. This feature is present at the enriched PF since it is important prosodic information which participates in building the Focus structure of the sentence. It is a strong feature, and in virtue of being strong, this feature needs to be checked off overtly in the syntax. In this sense, XP-Scrambling becomes obligatory.

The enriched PF provides an interface at which XP-Scrambling and prosody interact, and this obviates the necessity to postulate an additional abstract level of Functional Form. The four functional approaches to XP-Scrambling in Russian briefly described in this chapter (King, 1993; Bailyn, 1995; Kondrashova, 1996; Junghanns and Zybatow, 1995) pursue an alternative type of Focus-driven analysis. The level of FF is claimed to host covert Scrambling (in addition to overt Scrambling in the syntax) in order to make all surface word order in Russian obey a general

principle according to which given information (Topic) should precede new information (Focus). In contrast, the proposed Focus-driven analysis of XP-Scrambling which occurs at the enriched PF level makes it possible to account for Scrambling without postulation of this additional abstract level. It also permits an explanation of the interaction between XP-Scrambling and prosodic signalling of topic-focus structure, and how it affects ambiguity related to projecting Focus. This analysis also provides a necessary first step toward uncovering the specific focus properties of Split Scrambling discussed in Chapter 6 of this dissertation.

Chapter 4: Processing Properties of XP-Scrambling

4.1	Introduction	122
4.2	Garden-Path Model of Sentence Processing	124
4.2.1	Overview	124
4.2.2	Processing of Scrambling Constructions in German (Bader, 1994)	130
4.2.3	Processing of Scrambling Constructions in Japanese (Yamashita, 1996)	132
4.3	Analysis of Russian Experimental Sentences with XP-Scrambling	133
4.3.1	The NOM/ACC Ambiguity	133
4.3.2	The INSTR Ambiguity	137
4.3.3	The DAT Ambiguity	142
4.3.4	Summary	148
4.4	Experiment 1: Meaning Accessibility Judgments	149
4.5	Experiment 2: Overall Sentence Reading	164
4.6	Summary of Chapter 4	179

4.1 Introduction

The general goal of the research reported in this chapter is to investigate the processing characteristics of XP-scrambling constructions in Russian. The two experimental studies reported here are designed to lay the foundation for a model of Russian sentence processing by addressing basic questions about the processing of XP-Scrambling. To the best of my knowledge, the processing characteristics of XP-Scrambling in Russian have not been studied before. In particular, two hypotheses are tested. Hypothesis one is that the proposed universal strategy, Minimal Everything, of the Garden-Path theory (which subsumes principles of structure building – Minimal Attachment, Late Closure, the Minimal Chain Principle – and the principle which guides second pass parsing, Minimal Revisions) applies in the processing of Russian and is sufficient to account for processing of Russian XP-scrambling constructions. Hypothesis two is the Scrambling Complexity hypothesis; that is, there is an increased processing load associated with XP-scrambling operations. It is known that Wh-movement carries a processing cost. A tentative suggestion has been made in Chapter 2 according to which since Wh-movement and XP-Scrambling in Russian share the same characteristics, (both are of A'-movement type and leave a trace behind) they possibly may be manifestations of the same phenomenon. So it is plausible to suppose that the various word orders derived by XP-Scrambling are processed like familiar filler-gap dependencies of the Wh-movement type.

The Garden-Path theory of sentence processing (Frazier, 1978; Frazier and Fodor, 1978; Frazier and Clifton, 1996 and references therein) (Section 4.2.1) holds that MA, LC, the MCP, and Minimal Revisions are innate and universal; all languages are processed in the same way, and no parameterization of the parser is necessary. (See Frazier and Clifton, 1996, Chapter 2 for discussion of apparent counterevidence to universality of Late Closure.) The question of whether there are processing differences among languages with respect to XP-Scrambling is currently being investigated. Two recent processing studies of XP-Scrambling, in German (Bader, 1994)

(Section 4.2.2) and in Japanese (Yamashita, 1996a; 1996b) (Section 4.2.3), have not found complexity in terms of processing load associated with scrambled word orders in these two languages. This seems somewhat surprising given the linguistic hypothesis that scrambled word orders are more complex in terms of structure than unscrambled ones. So further empirical results would be welcome to clarify this issue. Russian XP-scrambling constructions present a new set of materials to test the Scrambling Complexity Hypothesis.

The experimental sentences chosen for the purposes of testing the two hypotheses are globally ambiguous sentences of three types, the NOM/ACC, INSTR and DAT ambiguities. The NOM/ACC ambiguity is chosen because it is found in many basic sentences and provides a good starting point for a general investigation of the processing characteristics of Russian. It is also found in many other languages and its implications for processing theory have been discussed for German by Hemforth, Konieczny, Scheepers, and Strube (1994). The INSTR ambiguity is a novel one since it is based on an ambiguity between an adjunct and an argument, an ambiguity important for Construal (Clifton and Frazier, 1996). Finally, the DAT ambiguity is an ambiguity of attachment site which crucially relies on bidirectionality of Scrambling. In general, the intention has been to capitalize on specific aspects of the Russian grammar, particularly its rich inflectional morphology, not found in many other languages whose processing characteristics have been studied in psycholinguistics.

In order to investigate how these globally ambiguous Russian sentences are processed, it is necessary to consider their syntactic structure first. In Section 4.3 the syntactic background necessary for analyzing the experimental materials is provided. In addition, theoretical predictions are set out about how such structures can be expected to be processed if the Garden-Path model is correct for Russian.

Experiment 1 (Section 4.4) is an off-line questionnaire to test application of the MCP and Minimal Revisions in processing of Russian XP-scrambled constructions and to provide a basis for an on-line Experiment 2 (Section 4.5). Experiment 1 tests the meaning accessibility for each of

the three ambiguity types by asking subjects to rate how natural each possible meaning is. If it can be shown that subjects systematically favor unscrambled structures and avoid revisions, this would be prima facie evidence for the MCP and Minimal Revisions.

Experiment 2 (Section 4.5) is an on-line reading study designed to investigate how XP-scrambling constructions in Russian are processed by comparing comprehension question data and reading times for scrambled and unscrambled sentences. The comprehension question data should provide more information about whether the MCP and Minimal Revisions are at work in processing of Russian XP-scrambling constructions. Easier accessibility of one meaning over the other and a shift in patterns of accessibility as a function of word order will be an argument in favor of these principles. With respect to reading time, if the data show that reading times lengthen as a result of XP-Scrambling, this can be taken as evidence for an extra processing load associated with XP-Scrambling, that is, the Scrambling Complexity Hypothesis.

Chapter 4 concludes Part I of the dissertation, whose goal was a syntactic, functional and psycholinguistic investigation of Russian XP-Scrambling.

4.2 The Garden-Path Model of Sentence Processing

4.2.1 Overview

Syntactic sentence processing is the set of mental operations by which hearers and readers assign syntactic structure to sentences. This process consists of two major components. First-pass parsing consists of building a phrase marker by assigning category information to terminal nodes (lexical items) and combining them to create larger constituents. Reanalysis is the revision of this initially-built structure if it later turns out to be incorrect. These operations are modeled by several competing theories of sentence processing, which differ both in details and in basic assumptions about the architecture of Human Sentence Processing Mechanism (HSPM). Though there is some degree of consensus, there remain differences on some central issues.

Depending on how the initial structure of a sentence is built, the models can be divided into three major classes, serial, parallel and delay models. Serial models argue for incremental, left-to-right construction of one particular structure for each given sentence (Kimball, 1973; Fodor, Bever, and Garrett, 1974; Frazier, 1978; Frazier and Fodor, 1978; Frazier, 1987, 1993; Inoue and Fodor, 1995; Fodor and Inoue, 1995; Frazier and Clifton, 1996; Gorrell, 1992, 1993; Weinberg, 1993, 1994, among others). Parallel theories assume the building and maintenance of several competing structures simultaneously (Gorrell, 1989; Gibson, 1991; Berwick and Fong, 1995, among others). HSPM constructs all possible structural analyses and carries these along in parallel, abandoning a candidate analysis either when incompatible material (ruling that analysis out) is encountered or when working memory overload and some representations must be sacrificed. Theories of the third class require delay in building a structure until ambiguities are resolved in the input (Marcus, 1984; Pritchett, 1992). HSPM delays making structural commitments until evidence indicating which analysis is correct becomes available.

The first and most influential of serial parsing theories is the Garden-Path model (Kimball, 1973; Frazier, 1978; Frazier and Fodor, 1978; Frazier, 1987; De Vincenzi, 1991). HSPM constructs just one structural analysis, and is prepared to abandon that analysis (and construct an alternative one) if the initial analysis proves to be incorrect. Presumably, costs are associated with reanalysis (revision). An important component of this model is a set of parsing principles which are argued to be universal and innate. Informally stated, Minimal Attachment (MA) does not allow postulation of any potentially unnecessary nodes. Late Closure (LC; also known as Right Association) requires attachment of new items into the clause or phrase currently being processed if grammatically permissible. These principles determine the preferred syntactic analysis of ambiguous strings. While processing of unambiguous sentences (provided they do not contain special difficulties) is uneventful, ambiguous sentences present a challenge for HSPM which can help to reveal its underlying properties. Thus, ambiguous sentences are extremely important materials for the purposes of studying principles that lie in the basis of the HSPM.

A clause is syntactically ambiguous when it has two (or more) different syntactic structures (which usually correspond to two separate meanings). Syntactic ambiguity can manifest itself in two ways: it can be global or temporary. In a case of global ambiguity there is more than one valid syntactic structure that can be assigned to a sentence as a whole (1). In cases of temporary ambiguity, at some point in the sentence the identity and/or attachment site of a constituent is locally indeterminate. If the sentence is well-formed, at least one choice of local structure will prove adequate as a whole, but other choices will lead to an incorrect structure which conflicts with later words in the input string (2). In these examples, the ambiguity region is shown in italics:

- (1) *Flying planes* can be dangerous.
 STRUCTURE 1: [DP A N] MEANING 1: 'Planes that fly can be dangerous.'
 STRUCTURE 2: [VP V DP] MEANING 2: 'To fly planes can be dangerous.'
- (2) The horse *raced past the barn* fell.
 '[DP The horse] [VP raced ...]' INITIAL INCORRECT RESOLUTION OF TEMPORARY AMBIGUITY
 '[DP The horse] [CP raced ...]' FINAL REVISED RESOLUTION OF TEMPORARY AMBIGUITY

In the Garden-Path model, MA accounts for preferences in resolution of such ambiguities as main clause/reduced relative clause (see (2) above), VP attachment over DP attachment of the PP, as illustrated in (3), DP-conjunction analysis rather than IP (CP) conjunction, as shown in (4). The examples that follow are drawn from the literature (particularly, Frazier, 1989), and will not be credited individually.

- (3) John hit the girl *with a book*.
 John [VP hit [DP the girl] [PP with a book]] MINIMAL ATTACHMENT
 John [VP hit [DP [the girl] [PP with a book]]] NON-MINIMAL ATTACHMENT
- (4) Ernie kissed Marcie *and her sister* laughed.
 Ernie kissed [DP Marcie and her sister] MINIMAL ATTACHMENT
 [CP Ernie kissed Marcie] and [DP her sister laughed] NON-MINIMAL ATTACHMENT

Late Closure is a HSPM strategy which chooses between two existing equally minimal attachments. Late Closure states that "when possible, attach incoming material into the clause or

phrase currently being parsed" (Frazier, 1978). It will favor the direct object analysis in (5), and low attachment of the adverb and of the PP, as shown in (6) and (7), respectively:

- | | | |
|-----|--|-------------------------------|
| (5) | Since she always jogs <i>a mile</i> seems like a short distance to her.
Since she always [VP jogs a mile]
Since she always [VP jogs][CP a mile] | LATE CLOSURE
EARLY CLOSURE |
| (6) | Joyce said Tom left <i>yesterday</i> .
Joyce said Tom [VP left yesterday]
Joyce [VP said [Tom left] [yesterday]] | LATE CLOSURE
EARLY CLOSURE |
| (7) | Jessie put the book Kathy was reading <i>in the library</i> ...
Jessie put the book Kathy was [VP reading [PP in the library]]
Jessie [VP put [DP the book Kathy was reading] [PP in the library]] | LATE CLOSURE
EARLY CLOSURE |

In current versions of the Garden-Path model, MA and LC are viewed as falling out of the general architecture of HSPM. The processor adopts the first analysis available to it. The Minimal analysis will be available earlier than nonminimal ones due to the fact that fewer nonterminal nodes will be required to build the former compared to the latter. Initially, cross-linguistic work on a variety of materials from languages as diverse as Italian, Spanish, and Japanese were compatible with MA and LC being universal principles of structure-building. However, this assumption about universality of the structural principles was challenged in the late 1980s because when tested on materials from other languages, it appeared that Late Closure is a language-specific strategy (Cuetos and Mitchell, 1988; 1991). It applies broadly in English, but Spanish, Italian, German, Japanese and some other languages seem to favor Early Closure in some constructions in which English favors LC. Frazier and Clifton (1996) summarize data showing that even in English, LC preference varies depending on constructions. Their Construal theory claims that non-primary phrases such as relative clauses, adverbial clauses, adjunct predicates are not necessarily immediately integrated into a fully determinate syntactic phrase marker. Instead, they simply "associate" to the current thematic processing domain (the extended projection of the last theta-assigner). This association constitutes a part of the Construal principle. According to the second part of Construal, the processor may then use any structural

and non-structural information to determine the appropriate place for the non-primary phrase within this thematic domain. Influencing this decision will be the variety of contrasts with other constructions that might have been employed instead, which vary from language to language. (See also Gilboy and Sopena, 1996; Frazier and Clifton, 1996; Gibson, Pearlmutter, Canseco-Gonzales, and Hickok, 1996 for discussion).

Investigation of constructions with filler-gap dependencies revealed another principle, the Minimal Chain Principle (MCP) (de Vincenzi, 1991) which is also argued to be universal. A movement chain consists of a moved phrase and its trace. The MCP states that unnecessary chain members should not be postulated; and when necessary, postulation of required chain members should not be delayed. The MCP predicts, for instance, that in cases of ambiguity involving null subjects, the parser will prefer to postulate a *pro* that is in a singleton chain, as in (8a), to a *pro* that is in a longer chain, as in (8b):

- (8) a. *pro* telefonera'.
 pro will telephone
 'pro will telephone.'
- b. *pro*_i telefonera' Gianni_i.
 pro will telephone Gianni
 'Gianni will telephone.'

Generalizing over these principles, Inoue and Fodor (1995) have proposed that the Garden-Path parser follows the single strategy of Minimal Everything. That is, given two possible structures, one more complex than the other, the parser pursues the less complex one until there is evidence to the contrary.

Summarizing up to this point, the Garden-Path theory of sentence processing describes the HSPM as a serial device that is (constructing one analysis at a time), incremental (constructing the analysis as the words of a sentence are encountered), and full-attachment (constructing a connected tree that incorporates all words of the input received so far). The grammar does not always uniquely determine the analysis of an input sentence. Because the input can be ambiguous, tree building is guided by ambiguity-resolution principles, Minimal Attachment, Late

Closure, the Minimal Chain Principle, and Construal. Since these principles are argued to be innate and fully universal, there is no parameterization of the parser.

Advocating a serial, incremental, and full-attachment processing, the Garden-Path model predicts that the HSPM will sometimes make mistakes. So it also has to account for what the HSPM does when the current analysis of the sentence turns out to be incorrect. Since it appears that the HSPM often manages to recover after such an error, this requires a mental mechanism which is responsible for reanalysis. A number of models of garden-path recovery have been proposed; see the papers in Ferreira and Fodor (in press). For example, in the Diagnosis model (Fodor and Inoue, 1995) the complexity of revising an analysis is a function of the transparency of the error signal. Reanalysis is governed by the same general preference principles as first analysis, namely, MA, LC, and the MCP. In general, as is the case with the structural principles that govern the initial syntactic analysis, in reanalysis the parser follows the Minimal Everything strategy. In the case of reanalysis this becomes the Minimal Revisions strategy: Don't make an unnecessary revision, and when revision is necessary, make the minimal revision, maintaining as much of the already assigned structure and interpretation as possible.

Until recently, the majority of the studies which tested the predictions of the Garden-Path model have been conducted on English. Recent cross-linguistic studies provide an opportunity for testing whether the processing principles identified to date have been biased by language-specific aspects of English. Research has been conducted on languages varying from languages quite closely related to English, such as German and Dutch, to other Indo-European languages such as Spanish, Italian, and French, and there is now a fast growing body of experimental studies of Japanese, Korean, and Chinese.

Slavic languages, and Russian in particular, make it possible to expand this variety and several of their typological properties make them an interesting test ground for predictions of the Garden-Path theory. Although Russian is an SVO, right-branching language (like English), it exhibits rich inflectional morphology with overt Case markers (like German) and free word order

often thought of as discourse-oriented (like Japanese). On the other hand, unlike English it is a Scrambling language, and unlike German and Japanese it is not verb- or head-final. In addition, it allows Split Scrambling, i.e., discontinuous DPs and PPs. All these characteristics make Russian an interesting case for testing models of sentence processing. In what follows it will be claimed that the Garden-Path theory of sentence processing can successfully account for the processing of Russian XP-scrambling constructions without need for modification.

4.2.2 Processing of Scrambling Constructions in German (Bader, 1994)

An important question in current research on sentence processing is whether languages are processed in the same way or differently. The Garden-Path model of sentence processing makes the strongest claim in arguing for one universal parser which handles all languages in the same way, subject only to differences in their grammars. Bader (1994) has investigated the implications of the universal parser hypothesis for the processing of German. German is closely related to English, but differs from English in being SOV and in allowing more freedom of word order. Bader shows that despite these differences, both languages are processed largely in accord with the same principles.

As a part of this larger project concerning the processing of German in general, Bader investigates implications of the Garden-Path theory for the processing of scrambling constructions in German, in particular, whether the MCP is applicable to such constructions. In a broad range of examples, almost every permutation of arguments and adverbials can be found. Bader distinguished between basic and derived word orders, on the one hand, and neutral and discourse-marked word orders, on the other. He observes that there is no simple one-to-one mapping between the two divisions. With lexical DPs, a word order is unmarked when it is basic. A scrambled clausal word order is derived but can be perceived as either marked or unmarked depending on definiteness of the two DPs involved.

experiments combined with intuitive judgments show no increased processing complexity of XP-scrambling constructions, in contradiction to the Minimal Chain Principle of the Garden-Path theory.¹

4.2.3 Processing of Scrambling Constructions in Japanese (Yamashita, 1996a; 1996b)

Yamashita (1996b), citing a Japanese corpus study by Yamashita and Suzuki (1996), notes an extremely low frequency of scrambling constructions in Japanese; the study found that the frequency of any type of scrambled sentence in a transcription of informal discussions was less than 1%. Canonically ordered sentences have their arguments in the order NP-ga NP-ni NP-o, that is, S IO DO V, as in (11a). Non-canonical word orders (11b-d) are derived from the canonical (11a) by XP-Scrambling which adjoins the scrambled phrase to the left of IP:

- (11) a. *Wakai zimuin-ga mukuti-na syatyoo-ni omosiroi hon-o ageta.* UNSCRAMBLED
 young secretary-NOM quiet president-DAT fun book-ACC gave
 'A young secretary gave the quiet company president a fun book.'
- b. *Mukuti-na syatyoo-ni wakai zimuin-ga omosiroi hon-o ageta.* DAT SCRAMBLED
- c. *Omosiroi hon-o wakai zimuin-ga mukuti-na syatyoo-ni ageta.* ACC SCRAMBLED
- d. *Omosiroi hon-o mukuti-na syatyoo-ni wakai zimuin-ga ageta.* DAT, ACC SCRAMBLED

The scrambled word orders (11b-d) were read as quickly as the canonical order (11a), that is, no significant difference was observed across the four word orders. Yamashita concluded that contrary to expectations, there was no increased difficulty in processing scrambled sentences in Japanese, and she speculates that this is because the parser appears to have utilized Case information independently of the word-order.

¹ See also Gorrell (1996) on the processing of Wh-movement and Scrambling constructions in German; Friederici (in press) presents ERP experiments on German examples.

4.3 Analysis of Experimental Sentences with XP-Scrambling

In order to determine the predictions of the Garden-Path model for the processing of the Russian experimental sentences with XP-Scrambling, it is necessary to consider their syntactic structures. There were three types of Russian sentences tested in Experiments 1 and 2, involving ambiguities for phrases in the NOM/ACC, INSTR, and DAT Cases. As will be shown, each of the three ambiguity types raises different issues with respect to XP-Scrambling. In what follows I will discuss each ambiguity type in turn, considering for each the specific characteristics of its syntactic structure and how processing load is predicted to vary, for three surface word orders.

The sentences used as experimental materials in the two experiments reported in this chapter were all globally ambiguous. For such sentences more than one valid syntactic structure can be assigned, resulting in two distinct semantic interpretations which will be referred to as “meanings”. The three word orders² which were prepared for each globally ambiguous sentence differed in the surface word order placement of one crucial constituent – a DP marked morphologically as NOM/ACC, INSTR, and DAT, respectively – which occurred below the verb, immediately above the verb, or sentence-initially. Examples (12), (15), and (20) below illustrate each of the three ambiguity types in turn, together with their two possible meanings, and also present the three word order variants. The constituent whose placement differs among variants is italicized.

4.3.1 The NOM/ACC Ambiguity

The ambiguity illustrated in example (12) arises because the NOM and ACC case-markers coincide in DPs *trolleybus* ‘trolleybus-NOM/ACC’ and *avtobus* ‘bus-NOM/ACC’; either

² Experiment 1 (Section 4.4) employed all three variants of each sentence, in an off-line task which gathered judgments about the availability of the two meanings. However, Experiment 2 (Section 4.5) employed only two word order variants, (a) and (c) sentences in example (14), and (a) and (b) in examples (17) and (22).

could be subject or direct object. Word order does not disambiguate because of the possibility of XP-Scrambling; either subject or direct object, or both, can be scrambled:³

- | | | | | | |
|------|----|----------------------------------|-------------------|--------------------------------|------------------|
| (12) | a. | Trolleybus
trolleybus-NOM/ACC | obognal
passed | <i>avtobus.</i>
bus-NOM/ACC | BELOW THE VERB |
| | b. | Trolleybus | <i>avtobus</i> | obognal. | ABOVE THE VERB |
| | c. | <i>Avtobus</i> | trolleybus | obognal. | SENTENCE-INITIAL |
- MEANING 1: 'The trolleybus passed *the bus*.'
MEANING 2: 'The *bus* passed the trolleybus.'

The NOM/ACC ambiguity is frequent in languages of the world for which word order is not an invariant cue to grammatical function. Languages which employ overt case marking differ with respect to how much morphological ambiguity they exhibit, and which particular Cases fall together.⁴ In Russian, there is NOM/ACC neutralization only for nouns belonging to Declension classes 2 and 3 when these are matched in gender and animacy. Thus, in (12), *trolleybus* 'trolleybus-NOM/ACC' and *avtobus* 'bus-NOM/ACC' are both from Declension Class 2, masculine and inanimate.

Given the hypothesis that the canonical word order in Russian is SVO (see Section 2.2, Chapter 2), Meaning 1 is obtained when example (12a) is taken as an unscrambled word order with the S-Structure schematically shown in (13a). In order to obtain Meaning 2, it is necessary to assume that both the subject and the direct object are XP-scrambled, as shown in (13b):

³ In English, a similar ambiguity is possible only between direct and indirect object in sentences with Wh-movement (see Fodor, 1978, for discussion):

- (i) Who did the nurse bring the doctor?
a. Who_i did the nurse bring t_i the doctor?
b. Who_i did the nurse bring the doctor t_i?

⁴ See Hemforth, Konieczny, Scheepers, and Strube (1994) for discussion of a similar ambiguity in German.

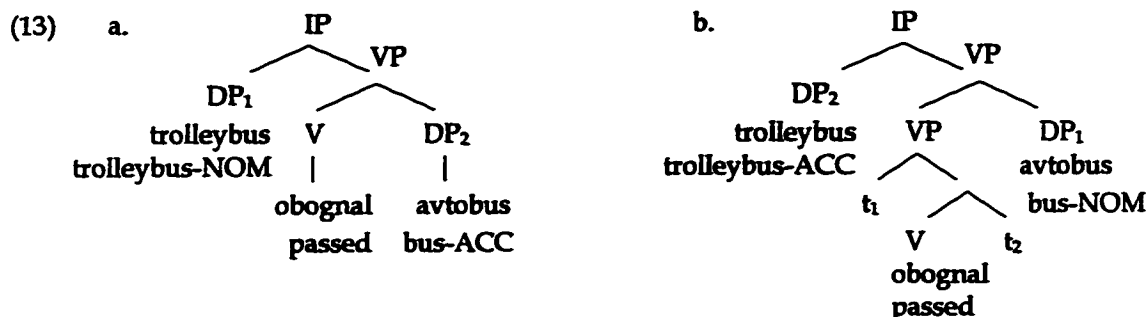

MEANING 1: 'The trolleybus passed the bus.'

MEANING 2: 'The bus passed the trolleybus.'

In contrast to (12a), where Meaning 1 and Meaning 2 reflect unscrambled and scrambled word orders, respectively, in example (12b), XP-Scrambling is necessary for both meanings, as shown in (14a, b):

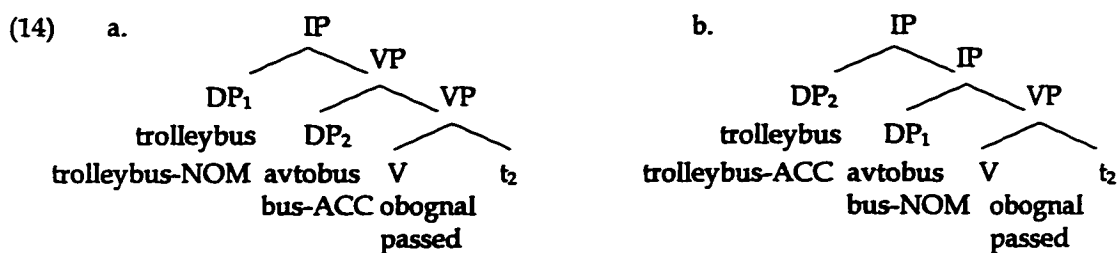

MEANING 1: 'The trolleybus passed the bus.'

MEANING 2: 'The bus passed the trolleybus.'

Notice that (14c) has a reversed order of DPs compared to (14b), and thus the analyses with respect to meanings are in mirror image. In schemata (15)-(16) and below, I abstract away from details of the syntactic derivation such as movement of subject to SPEC, IP, and movement of the verb to I⁰. What is relevant is that, following the syntactic assumptions concerning the nature of XP-Scrambling in Russian as discussed in Chapter 2, the scrambled direct object is left-adjoined to VP in (16a) and left-adjoined to IP in (16b).

Let us consider how the Below the Verb word order in (14a) might be processed, supposing that the parse proceeds from left to right in a strictly incremental fashion. When the parser encounters the first DP in the input *trolleybus* 'the trolleybus-NOM/ACC' in (14a), it is confronted with a morphological ambiguity: Should that DP be assigned NOM or ACC case? Certainly an interpretation as the NOM subject is predicted by the MCP: Given a choice between

an unscrambled structure (15a) and one with object Scrambling, the parser should pursue the unscrambled structure since it does not require the postulation of a chain. The verb follows the first DP in the input, and finally the second DP, will be interpreted as ACC direct object, completing the parse as a simple SVO structure to support Meaning 1 for (14a).

What is required for the parser to compute Meaning 2 for (14a)(=15b)? Two XP-Scrambling chains have to be postulated: One for object XP-Scrambling, and one for subject XP-Scrambling (subject Right Extraposition). And this is not all: If the MCP has applied to force interpretation of *trolleybus* 'trolleybus-NOM/ACC' as NOM and *avtobus* 'bus-NOM/ACC' as ACC, revision operations also will have to be invoked without any trigger in order to arrive at Meaning 2, violating the Minimal Revisions Principle. Thus, the structural interpretation required for Meaning 2 results in an OVS structure, and is presumably more complex because it involves postulating *two* scrambling chains and revision. Although the meaning is possible, it should be strongly dispreferred.

Processing of Above the Verb word order (14b) will depart from that for (14a) when the parser encounters the DP *avtobus* 'bus-NOM/ACC' as the second phrase in the input. Since no verb has yet been found, the parser at this point will be forced to postulate at least one chain for XP-Scrambling of a direct object. The choice is between retaining the first DP as subject, without revision, which forces the second DP to be the object, or else revising the first DP to be a scrambled object, which allows the second DP to be attached (without Scrambling) as the subject. Note that a processing account of the first alternative presupposes a particular theoretical stance on Object Scrambling. As we shall see, the processing account differs depending on whether we adopt an analysis permitting IP-adjunction only or a parameterized landing site theory for XP-Scrambling (the position taken in this dissertation, see Chapter 2). In contrast to the former analysis, the parameterized landing site analysis of XP-Scrambling allows both IP and VP to serve as adjunction sites.

If the SOV structure of (14b) for Meaning 1 were analyzed under the assumption that only IP is available as a landing site, the processing account must say that two chains are postulated: one S-Structure chain for object XP-Scrambling, and one covert chain for subject which would have to move across the IP-adjoined object to derive the surface word order. Thus the structure would be complex, and the first DP would require revision even though it remains the subject. In contrast, if the processing account assumes the parameterized landing site analysis, only one chain is postulated: The scrambled object is VP-adjoined, and no covert movement of subject is required. As will be shown in Section 4.4, the experimental data obtained in Experiment 1 are compatible with the parameterized landing site analysis, confirming the assumption that XP-Scrambling in Russian allows VP to serve as an adjunction site for object Scrambling. In what follows, I consider only the analysis permitting adjunction to both IP and VP.

Building the OSV structure for (14b) in order to obtain Meaning 2, as shown in (16b), will require a single but longer object XP-Scrambling chain, now adjoining to IP rather than VP, and a revision of role (from subject to object) for the first encountered DP, violating the Minimal Revisions Principle. For the Sentence-Initial variant (14c), considerations of processing precisely reverse those for Above the Verb (14b). Note that (14b) and (14c) differ only notationally, both involving a DP DP V structure. Meaning 2 for (14c) will require one XP-Scrambling chain while Meaning 1 will require one longer XP-Scrambling chain plus revision. Taken together, (14b) and (14c) are expected to support the generalization that, given two sentence-initial DPs both ambiguous between NOM and ACC, the preference is to assign these as subject and object, in order of their encounter.

4.3.2 The INSTR Ambiguity

Example (17) exhibits an ambiguity between a non-verbal secondary predicate and an adjunct *by*-phrase, the agent in passive constructions.

- (17) a. Smirnov byl poslan na zavod direktorom. BELOW THE VERB
 Smirnov-NOM was sent to the plant director-INSTR
- b. Smirnov direktorom byl poslan na zavod. ABOVE THE VERB
- c. Direktorom Smirnov byl poslan na zavod. SENTENCE-INITIAL

MEANING 1: 'Smirnov was sent to the plant as a director.'

MEANING 2: 'Smirnov was sent to the plant by the director.'

This ambiguity arises from the language-specific fact that the default morphological Case for Russian non-verbal secondary predicates in Russian is INSTR, exactly the Case taken by the adjunct agent DP in passive sentences. While the syntactic status of the non-verbal secondary predicate remains unclear, it looks like a standard instance of an argument small clause, as illustrated in (18):

- (18) Ivan sčitaet Petra durakom.
 Ivan-NOM considers Peter-ACC fool-INSTR
 'Ivan considers Peter a fool.'

Additional empirical facts such as possible co-occurrence of the non-verbal secondary predicate and the agent *by*-phrase in the same sentence (see examples in (20) below), free variability in the order with the obligatory locative argument (*na zavod* 'to the plant' in (17) above), and lexical restrictions on the type of verb allow us to assume as a working hypothesis that *direktorom* 'director-INSTR' in (17), taken as a non-verbal secondary predicate, is an argument small clause.

The S-Structure representation for Meaning 1 (small clause) and Meaning 2 (*by*-phrase) of example (17a) are shown in (19a) and (19b), respectively:

- (19) a.
-
- ```

graph TD
 IP --> DP1[DP
Smirnov
Smirnov-NOM]
 IP --> VP1[VP
byl
was]
 VP1 --> VP2[VP
poslan
sent]
 VP1 --> V_prime1[V']
 V_prime1 --> V_prime2[V']
 V_prime1 --> SC[SC
direktorom
director-INSTR]
 V_prime2 --> V_prime3[V']
 V_prime2 --> PP[PP
na zavod
to the plant]
 V_prime3 --> V_prime4[V']
 V_prime3 --> PP2[PP
na zavod
to the plant]

```

MEANING 1: 'Smirnov was sent to the plant as a director.'

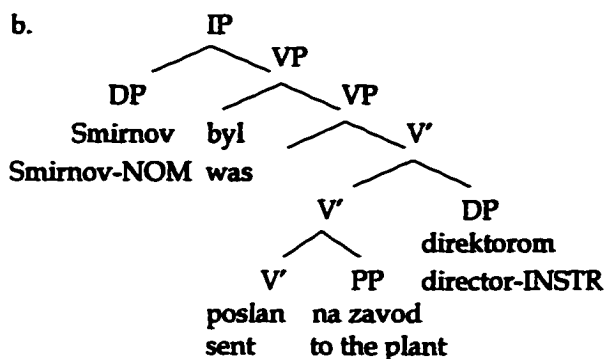

MEANING 2: 'Smirnov was sent to the plant by the director.'

As the structures shown in (19) illustrate, the INSTR phrase *direktorom* 'director-INSTR', whether interpreted as small clause (19a) or *by*-phrase of passive (19b), is attached in same the place in the tree. However, in rare instances both a small clause and a *by*-phrase are present in a sentence, as in (20). The marginal acceptability<sup>5</sup> of (20a) in contrast to the ungrammaticality of (20b) indicates that the small clause is attached higher than the *by*-phrase, when these co-occur:

- (20) a. ??Smirnov byl poslan na zavod direktorom Stalinym.  
 Smirnov-NOM was sent to the plant director-INSTR Stalin-INSTR  
 'Smirnov was sent to the plant as a director by Stalin.'
- b. \*Smirnov byl poslan na zavod Stalinym direktorom.  
 Smirnov-NOM was sent to the plant Stalin-INSTR director-INSTR  
 'Smirnov was sent to the plant as a director by Stalin.'

In the scrambled versions of (17), the INSTR phrase *direktorom* 'director-INSTR' will scramble either to a VP-adjoined position lower than the subject, as in Above the Verb (21a)=(17b), or to an IP-adjoined position higher than the subject, as in Sentence-Initial (21b)=(17c):

<sup>5</sup> The marginality of example (20a) is possibly due to a processing constraint against na doubly applied on-transparent use of Case (see Uehara, 1997).

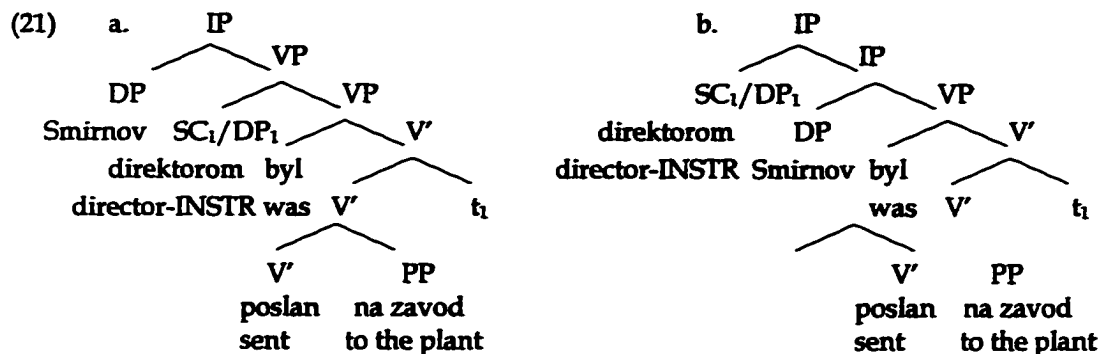

With respect to factors affecting the availability of its two meanings, the INSTR ambiguity is different from the NOM/ACC ambiguity discussed in Section 4.3.1 above. As we have seen, the INSTR phrase is ambiguous between a small clause argument and an adjunct *by*-phrase. Within any word order variant (Below the Verb, Above the Verb, and Sentence-Initial), different meanings do not arise with a contrast of unscrambled and scrambled word orders, as they did for the NOM/ACC ambiguity. In (17a), both meanings involve unscrambled structures, and in (17b) and (17c), both involve Scrambling, with adjunction to VP and IP, respectively.

The difference between meanings lies, rather, in the internal structure of the INSTR phrase. For Meaning 2, the phrase is a simple DP, while for Meaning 1 it has the internal structure of a non-verbal small clause which includes subject PRO. In this small clause, the PRO subject must be controlled by the subject of the main clause. Thus, certain movements of the small clause can be ruled out if they result in a violation of Control Theory.<sup>6</sup> In particular, the matrix subject does not c-command small clause PRO in the Sentence-Initial word order variant (17c)=(21b). A grammatical constraint should rule out Meaning 1 in this instance.

If grammatical considerations select between meanings for Sentence-Initial (17c), these do not bear on the remaining word orders, Below the Verb (17a) and Above the Verb (17b). What processing considerations apply to these latter word order variants, for which the two meanings

<sup>6</sup> In general, as was shown in Chapter 2, IP- and CP-clauses can scramble freely in Russian, and the working assumption would be that the same holds for small clauses, including those which are non-verbal secondary predicates. And since Scrambling of a small clause does not involve crossing a complementizer position, it would be subsumed under clause-internal XP-Scrambling.

both involve unscrambled structures or scrambled structures, respectively? Recall that Frazier and Clifton (1996) raised the issue of a possible difference in the way arguments (primary phrases) and adjuncts (non-primary) are processed (see Section 4.2.1). Briefly, their proposal was that the processing of arguments is determined by the universal principles of the Garden-Path theory, while the processing of adjuncts obeys the Construal Principle. The latter principle states that an adjunct will only be “associated” into the current thematic domain, and that its attachment is guided by non-structural, i.e., pragmatic and semantic, factors. However, given ambiguity between argument and adjunct status for a phrase, that is, competition between universal parsing principles and Construal, attachment as argument should win.

It is possible, then, that data on the processing of the INSTR ambiguity can shed light on this new development of the Garden-Path theory, for a type of construction and a language quite different to those considered so far. The working hypothesis adopted in this dissertation, albeit without a detailed examination, favors argument status for the INSTR small clause (Meaning 1), cf. adjunct status for the *by*-phrase of the passive (Meaning 2). This being so, Frazier and Clifton’s proposal seems to predict a preference for Meaning 1, attaching the critical DP as an argument, over Meaning 2’s adjunct *by*-phrase attachment.<sup>7</sup> This pattern should hold, whether the INSTR phrase is encountered in an unscrambled structure, as in *Below the Verb* word order (17a)=(19), or in a scrambled structure, as in *Above the Verb* (17b)=(21b). Scrambling of the INSTR phrase does not change its syntactic functions: It can still be interpreted as either an argument (Meaning 1) or an adjunct (Meaning 2). All that changes is its location in the surface word order. In (17b) the INSTR phrase appears immediately before the verb, sentence-medially; crucially, it is lower than the matrix subject, so that no violation of Control Theory is at issue. Thus, if the argument

---

<sup>7</sup> If it turns out that examples like (17) in fact involve ambiguity between two adjuncts, contra the working hypothesis, then the Construal Principle predicts that non-structural factors such as lexical properties of individual verbs and semantic-pragmatic preferences will determine the pattern of meaning preferences. Although the verbs used in the sentences with INSTR ambiguity all permit small clauses and *by*-phrases, there may be differences in the plausibility of small clause for a particular verb. The verbs also differ in frequency; the verb *poslat* ‘to send’ of example (17) being by far the most frequent. It also has the most generic meaning, in the sense that it can replace any other verbs of this class.

interpretation of the INSTR phrase is preferred in general (as in Below the Verb word order (17a)), then this preference should remain the same in (17b)'s scrambled word order.

#### 4.3.3 The DAT Ambiguity

The DAT ambiguity, as exemplified in (22), arises as an ambiguity between attachment of a DAT phrase as the subject of the matrix clause and as the indirect object of the embedded clause. This involves a morphological phenomenon specific to Russian in which modal predicates arguably take DAT subjects.<sup>8</sup> In (22), for expository purposes, the direct object of an experimental item actually employed in Experiments 1 and 2, *principy organizacii torgooli* 'the principles of commerce organization', has been simplified (or omitted, as in the trees) in what follows:

- |      |    |                        |                        |                        |                                     |                             |
|------|----|------------------------|------------------------|------------------------|-------------------------------------|-----------------------------|
| (22) | a. | Prixoditsja<br>have to | ob"jasnjat'<br>explain | principy<br>principles | prepodavateljam.<br>instructors-DAT | BELOW THE VERB <sup>9</sup> |
|      | b. | Prixoditsja            | prepodavateljam        | ob"jasnjat'            | principy.                           | ABOVE THE VERB              |
|      | c. | Prepodavateljam        | prixoditsja            | ob"jasnjat'            | principy.                           | SENTENCE-INITIAL            |

MEANING 1: 'pro have to explain the principles to *the instructors*.'

MEANING 2: '*The instructors* have to explain the principles.'

The DP *prepodavateljam* 'instructors-DAT' can be understood as the indirect object of the embedded double-object verb *ob"jasnjat'* 'explain' (Meaning 1) or as the subject of the matrix modal predicate *prixoditsja* 'have to' (Meaning 2). While English does not allow DAT subjects, it does exhibit an ambiguity with DAT arguments in sentences containing two double-object verbs,

<sup>8</sup> Two questions concerning the syntactic structure of constructions with modal predicates are still under debate in Slavic syntax. One is whether Russian really does have DAT subjects. The second is whether modal predicates behave like auxiliary verbs in English and appear in monoclausal sentences, or whether they project their own IP structure and take infinitival complements. In this dissertation, I adopt Kondrashova's (1992) analysis according to which Russian indeed has DAT subjects and constructions with modal predicates are biclausal.

<sup>9</sup> For two sentences of the DAT ambiguity type, the Below the Verb word order involved a late placement of the DAT-marked DP, but not one that was sentence-final. This was dictated by considerations of felicity.

as in (23). This ambiguity in English is similar to the DAT ambiguity in Russian in the sense that both involve attachment sites low and high in the tree.

(23) I introduced the boy that read the book to John.

MEANING 1: I introduced [<sub>DP</sub> the boy that read [<sub>DP</sub> the book] [<sub>DP</sub> to John]].

MEANING 2: I introduced [<sub>DP</sub> the boy that read [<sub>DP</sub> the book]] [<sub>DP</sub> to John].

There is a small number of modal predicates in Russian and they are not morphologically uniform. They include verbal predicates like *prixoditsja* 'have to', as in (22), *sleduet* 'should', *udavat'sja* 'manage to', and so on. These verbal modal predicates differ from adverbial modal predicates like *neobxodimo* 'it is necessary', *pora* 'it is time', *možno* 'it is possible', and so on, in that the former possess verbal characteristics (tense and aspect) while the latter are used with the auxiliary verb *byt'* 'to be'.<sup>10</sup> Both types of modal predicate subcategorize for a DAT subject but show no agreement with that subject (in contrast to NOM subjects). The experimental sentences with DAT ambiguity tested in Experiments 1 and 2 (see Sections 4.4 and 4.5) included both verbal and adverbial modal predicates.

The S-Structure of Meaning 1 of (22a) which represents the canonical SVO word order without Scrambling is shown in (24a), and the S-Structure of Meaning 2 which involves Long-Distance subject Scrambling (Right Extraposition), is shown in (24b):

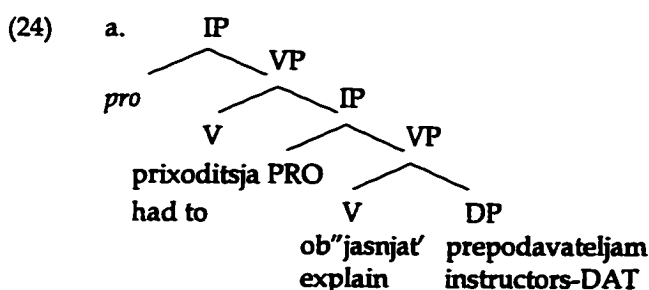

MEANING 1: *pro* have to explain [the principles] to the instructors.'

<sup>10</sup> In traditional Russian linguistics, modal predicates constitute a separate syntactic class referred to as *the category of state*. Kondrashova (1992) refers to the adverbial modal predicates as *A-predicates* (short for adverb/adjective).

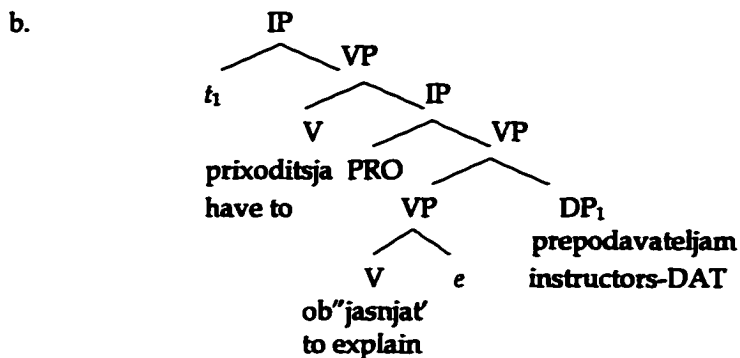

MEANING 2: 'The instructors have to explain [the principles].'

I assume that the implicit subject in (24a) is *pro*; (24b), on the other hand, has an implicit indirect object represented as *e* (empty category).<sup>11</sup>

For the Above the Verb word order (22b), Meaning 1 has the S-Structure represented in (25a) and Meaning 2, the S-Structure in (25b):

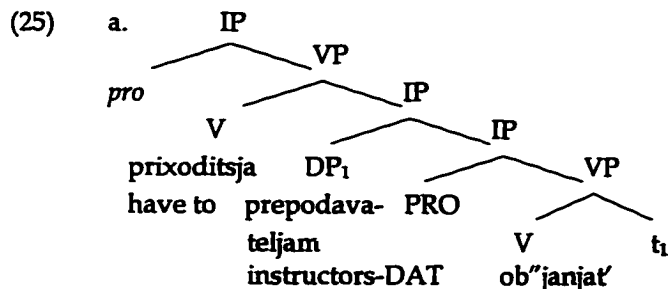

MEANING 1: '*pro* have to explain [the principles] to the instructors.'

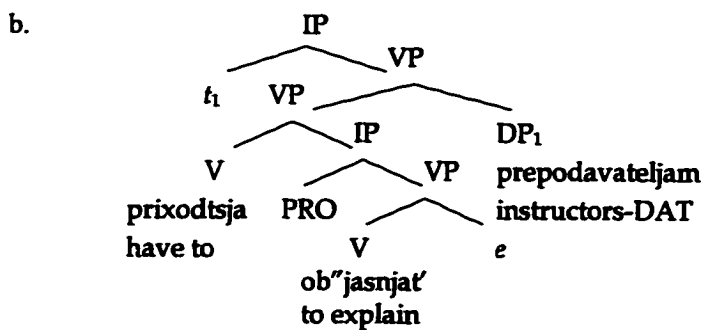

MEANING 2: 'The instructors have to explain [the principles].'

<sup>11</sup> See Rizzi (1986) for the theory of implicit arguments and the way they are represented in the syntactic structure of Italian. Yadroff (1992) applies Rizzi's arguments to Russian, and shows that Russian patterns with Italian in this respect.

The Above the Verb word order of the DAT ambiguity is special in that Scrambling is required in order to obtain either of the two meanings. However, the situation differs from that seen in the INSTR ambiguity. Here, the two meanings require different scrambles: For Meaning 1, the DAT indirect object has to move to the left embedded IP-adjoined position, and for Meaning 2, the DAT subject of the matrix clause has to move to the right matrix VP-adjoined position.

For the Sentence-Initial word order (22c), Meaning 1 has the surface representation in (26a), while Meaning 2 the representation in (26b):

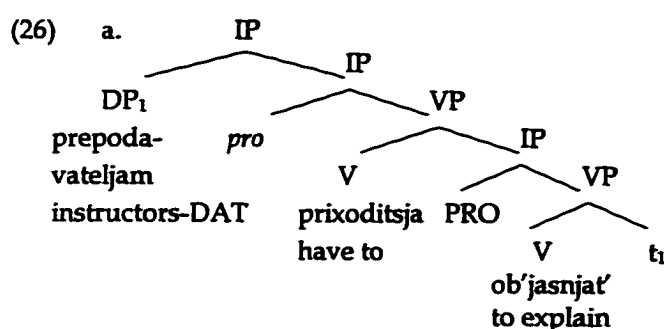

MEANING 1: 'pro had to explain [the principles] to the instructors.'

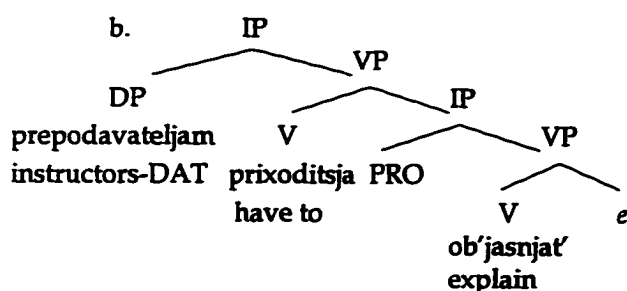

MEANING 2: 'The instructors have to explain [the principles].'

If we compare the S-Structures in (26) with those presented earlier in (24), we can see that (24a) represents an unscrambled structure (for Meaning 1), and (26b) also represents an unscrambled structure (but now for Meaning 2): the critical DP *prepodavateljam* 'instructors-DAT' is in a different D-Structure position in each. Thus, for Below the Verb word order (22a), it is Meaning 1 that does not involve Scrambling, while for Sentence-Initial word order (22c), it is Meaning 2. Conversely, the critical DP is a LD-scrambled subject (for Meaning 2) which is right-adjoined to

the embedded verb in (24b), or a LD-scrambled indirect object (for Meaning 1) which is left-adjoined to the matrix IP in (26a).

How will sentences with DAT ambiguity be processed? Consider how Below the Verb word order (22a) is processed. The first phrase in the input<sup>12</sup> is the modal predicate *prixoditsja* 'have to'. Since modal predicates of this type can take either an overt DAT subject or a *pro*, the absence of a lexical subject will force the processor to construct a structure with *pro* subject; the alternative would require postulation of a chain (for a scrambled lexical subject), in violation of the MCP. The phrases which follow (the embedded verb *ob"jasnjat* 'to explain' and its direct object *principy* 'principles-ACC') in no way conflict with this initial analysis, to force any revision. When the phrase *prepodavateljam* 'instructors-DAT' is finally encountered in the input, it is evident that its attachment as indirect object of the embedded should be preferred by Right Association and the Minimal Chain Principle. That lower attachment results in a simple structure, as shown in (24a). Higher attachment in which DP-DAT is treated as a right-extrapolated matrix subject, as shown in (24b), would require postulating a LD-scrambling chain, a violation of the Minimal Revisions Principle. Since Meaning 1 is an unscrambled structure, constructed directly off underlying D-Structure, a strong preference is clearly expected.

In contrast, expectations are not at all clear with respect to processing of Above the Verb example (22b), in which *prepodavateljam* 'instructors-DAT' is encountered early, before the embedded but after the matrix verb. Meaning 1 requires postulating XP-Scrambling of a DAT indirect object, but Meaning 2 also requires postulating XP-Scrambling, now for a DAT matrix subject. If it is the indirect object that is scrambled, it would have to move from its D-Structure position below the embedded verb and left-adjoin to the embedded IP. If it is the subject of the matrix verb that is scrambled, it would have to move from its D-Structure position and right-adjoin to the matrix VP. This is a case of competing XP-Scrambling chains. Above the Verb word

---

<sup>12</sup> Two experimental sentences with the DAT ambiguity had sentence-initial filler phrases for reasons of felicity.

order variant of the DAT ambiguity can shed light on the question whether XP-Scrambling in Russian is indeed bidirectional. If there were leftward movement only, we would expect Meaning 2 to be strongly dispreferred because it involves rightward XP-Scrambling of the subject.<sup>13</sup> If the experimental evidence shows that both meanings are available, the assumption of bidirectionality of XP-Scrambling in Russian would be confirmed.

Finally, consider now the processing of Sentence-Initial word order (22c). As foreshadowed in an earlier remark, the situation reverses that for Below the Verb word order (22a). That is, the first phrase in the input *prepodavateljam* 'instructors-DAT' is ambiguous between attachment as the scrambled object of a verb yet to be encountered and as an underlying DAT subject. A string preference for attachment as subject is predicted by the MCP, to avoid a Scrambling chain.

However, things may be more complicated in sentences like (22c); recall that the Garden-Path model considers processing to be *strictly* incremental. The two possible roles for a sentence-initial DAT phrase may not be equally available with no verb encountered yet in the input, since only a very limited class of predicates take a DAT subject, cf. the large class taking an indirect object, scrambled or otherwise. Uehara's (1997) proposal of a processing constraint against non-transparent use of Case (for Japanese) may be relevant. If this constraint were to apply, the parser might initially prefer to take the DAT phrase as a scrambled indirect object, despite the MCP violation which this would incur, DAT being a non-transparent Case for subjects in Russian. Note that as soon as the modal predicate *prixoditsja* 'have to' is encountered, next in the input, it would become clear that the DAT phrase can have an analysis as a subject, creating a structure much simpler than one involving LD-Scrambling (The DAT phrase cannot be an object of the

---

<sup>13</sup> A possible alternative analysis along the lines of Kayne's (1994) Antisymmetry theory would require I<sup>0</sup> and the VP to move leftward across the subject. This would not be the problem in the case of matrix clauses with modal predicates, as in (22) since they rarely contain any additional constituents. However, in other sentences with postverbal subjects, it can complicate matters substantially. (See Section 2.3.3, Chapter 2 and Section 3.3.5 for discussion of subject XP-Scrambling (Right Extraposition) in Russian and arguments against the VP-Evacuation hypothesis.)

modal predicate itself which obligatorily takes an infinitival complement.) Nothing in the input after that matrix verb conflicts with the attachment of the DAT phrase as subject. Meaning 2 is thus expected to have the preferred interpretation, though the early uncertainty arising with Sentence-Initial word order may make the preference less strong than the Meaning 1 preference predicted for Below the Verb word order.

#### 4.3.4 Summary

In sum, the experimental studies reported in the two following sections are designed to test whether several theoretical predictions of the Garden-Path theory are consistent with, and provide sufficient explanation for, the processing of three types of globally ambiguous Russian sentences. These predictions are as follows:

(a) The Minimal Chain Principle directs the parser to construct underlying unscrambled structures when they compete with possible scrambling structures (Below the Verb word order in both NOM/ACC; Below the Verb and Sentence-Initial word orders in DAT);

(b) The Minimal Revisions Principle directs the parser to avoid reanalysis unless new input conflicts with current analysis (Above the Verb and Sentence-Initial word orders in NOM/ACC, under the parameterized landing site theory of XP-Scrambling);

(c) The Construal Principle requires the parser to prefer argument attachment over adjunct attachment when both are possible (Below the Verb and Above the Verb word orders in INSTR);

(d) A grammatical principle (e.g., Control theory) can override Construal, a processing principle (Sentence-Initial word order in INSTR). Possibly, another processing constraint against non-transparent use of Case contributes to processing of Above the Verb word order in DAT.

#### 4.4 Experiment 1: Meaning Accessibility Judgments

Experiment 1 gathered ratings data reflecting the accessibility of each of two competing meanings of globally ambiguous sentences which fell into three ambiguity types. The experimental sentences were presented in three word orders, differing in the location of a critical element in a particular morphologically marked Case. These different word orders in the experimental sentences were used to set up a variety of situations through which the processing of XP-Scrambling could be explored. The goal of Experiment 1 was to test whether the relative accessibility of the meanings of globally ambiguous sentences would differ as a function of Scrambling, with patterns of meaning preference reflecting hypothesized processing costs for the structures associated with those competing meanings.

##### Method

*Subjects.* Fifty-one volunteer subjects, all native Russian speakers, participated successfully in the experiment, 17 in each of three versions of the experiment. Roughly two-thirds (N=33) were students attending Moscow Military Institute of Foreign Languages, the remainder being undergraduate students at Hunter College in New York who had recently come to the United States from Russia. Subjects were naive with respect to the purpose of the experiment, in which a questionnaire was completed requiring judgments about the accessibility of each of two different interpretations of written sentences. Completion of the questionnaire typically took 45 minutes.

*Materials and Design.* The experimental sentences, all globally ambiguous, were constructed as 18 triplets; for each ambiguity type, sentences within a triplet differed only in word order. In materials construction, every effort was made to refine experimental sentences so that its two possible meanings were equally plausible. There was, however, no formal assessment made of plausibility, the experimenter's native intuition serving as the only guide.

Materials fell into three types (NOM/ACC, INSTR, and DAT) defined by the Case-marking on a critical DP whose structural interpretation was the source of ambiguity. For each type, six triplets were generated around a "basic" sentence (in Below the Verb word order); the remaining two word orders of the triplet, Above the Verb and Sentence-Initial, placed the critical DP sentence-medially and -initially, respectively. Section 4.3 has already presented the relevant linguistic analyses of all three word orders for each ambiguity type. Appendix 1 presents experimental sentences in full: For convenience, (27)–(29) illustrating NOM/ACC, INSTR, and DAT ambiguities, respectively, repeat only the basic word order for the examples through which the ambiguity types have previously been introduced and discussed (see (14a), (17a), and (22a) above):

- (27) Trolleybus                      obognal                      avotobus.  
trolleybus-NOM/ACC              passed                      bus-NOM/ACC

MEANING 1: 'The trolleybus passed *the bus*.'

MEANING 2: '*The bus* passed the trolleybus.'

- (28) Smirnov                      byl poslan                      na zavod                      direktorom.  
Smirnov-NOM                      was sent                      to the plant                      director-INSTR

MEANING 1: 'Smirnov was sent to the plant *as a director*.'

MEANING 2: 'Smirnov was sent to the plant *by the director*.'

- (29) Prixoditsja                      ob"jasnjat'                      principy                      prepodavateljam.  
have to                      explain                      principles                      instructors-DAT

MEANING 1: 'pro have to explain the principles to *the instructors*.'

MEANING 2: '*The instructors* have to explain the principles.'

Materials in the experimental set were not controlled for length, though length was, of course, constant across sentences differing only in word order. Sentences with the NOM/ACC ambiguity were very short (mean length in characters 22, range 18–27), while those with the INSTR and DAT ambiguities were substantially longer with greater variability among triplets (mean lengths 64 and 61, ranges 39–81 and 40–83, respectively).

For each triplet, two unambiguous paraphrases were constructed, each expressing a different sentence meaning. The meanings expressed in these paraphrases will be referred to here



syntactically ambiguous, but they represented other types of ambiguity. Eight fillers had ambiguous attachment of a relative clause within a complex NP, as illustrated in (34), and six represented thematic role ambiguity within a complex DP, as shown in (35). The remaining 14 had different adverb, PP, and modifier attachment ambiguities. Two paraphrases were constructed for each filler, each unambiguously reflecting one of the available meanings:

- (34) a. Ja vzjal knigu u podruzi moej sestry, nedavno uexavšej za granicu.  
I took the book from friend-GEN my sister-GEN recently gone abroad
- b. Ja vzjal knigu u podruzi moej uexavšej za granicu sestry. MEANING 1 PARAPHRASE  
'I took the book from my gone-abroad sister's friend.'
- c. J vzjal knigu u uexavšej za granicu podruzi moej sestry. MEANING 2 PARAPHRASE  
'I took the book from my sister's friend who has recently gone abroad.'
- (35) a. Obvinenie direktora bylo neobosnovannym.  
accusations-NOM director-GEN were ungrounded.
- b. Direktor obvinjal neobosnovanno. MEANING 1 PARAPHRASE  
'The director's accusations were ungrounded.'
- c. Obvinenija v adres direktora byli neobosnovannymi. MEANING 2 PARAPHRASE  
'The accusations aimed at the director were ungrounded.'

The three sets of experimental items (six exemplars per ambiguity type, each with three word order variants) and 30 filler items were assembled to create the questionnaire; an item consisted of a sentence and its two associated paraphrases. So that identical materials would not be repeated to any subject, the questionnaire was constructed in three versions, word order variants of any experimental item being distributed over versions in a counterbalanced design. Filler items were identical across versions. Thus, any one version of the experiment presented 48 sentence-plus-paraphrases items in total, 18 experimental and 30 filler. The order of presentation of paraphrases for both experimental and filler items was counterbalanced across each ambiguity type so that for one sentence a particular type of paraphrase was the first (Meaning 1) while in the other it came second (Meaning 2). Experimental and filler items were interspersed in a pseudo-random order.

*Procedure and Data Treatment.* Each version of the questionnaire was presented to a different group of subjects in a paper-and-pencil format. Specific instructions which included two examples preceded the questionnaire proper. Subjects were instructed to read each sentence carefully, and then to rate each of its two paraphrases on a scale ranging from 0 to 3. The ratings were explained as follows:

- (36)
- 0 No such meaning exists for the sentence
  - 1 The meaning does not come to mind easily, but you agree that it is possible
  - 2 The meaning comes to mind second but not immediately, after reading the sentence
  - 3 The meaning immediately comes to mind, right after reading the sentence

Subjects were instructed to circle an appropriate number from 0 to 3 for each of the paraphrases, separately, to record their judgment about the accessibility of that meaning of the sentence.

Subjects' rating responses were screened for missing data. Two subjects with more than two data points missing were rejected and replaced. The ratings data were assembled into  $2 \times 6 \times 17$  matrices, for purposes of analysis, to reflect a design factorially combining meanings and Sentences. This analysis design brings together the ratings of two paraphrases (made by 17 subjects in any version of the experiment) for six exemplars of a given ambiguity type and word order; these had been distributed over versions by the counterbalanced materials design. In all, nine such matrices were separately prepared, one for each of three word order variants (Below the Verb, Above the Verb, Sentence-Initial) in three ambiguity types (NOM/ACC, INSTR, DAT). The data were analyzed parametrically in analyses of variance taking the Meanings factor as a repeated measure and the Sentences factor as non-repeated.

Two terms of the analysis of variance bear directly on the question around which the experiment was designed, and the results report to follow focuses on these. The main effect of the Meanings factor provides information about whether (for the exemplars of a given type and order, taken together) subjects gave reliably different accessibility ratings to the paraphrases which expressed competing meanings of a sentence. Statistical significance in this term indicates an overall preference for one meaning, and this will be presumed to reflect a lower processing

cost in assigning the relevant structure. The Meaning x Sentences interaction term of the analysis of variance is equally important; this provides information about whether the overall preference pattern seen for the exemplars, taken together, genuinely reflects meaning preferences for the exemplars considered individually. Non-significance in the interaction term indicates a reasonable consistency across sentences in the relative accessibility of competing meanings, and significance indicates variability. The latter is likely to arise when idiosyncratic lexical or pragmatic factors are contributors to the meaning preference pattern.<sup>14</sup> Where the two-way analysis produced evidence of this kind of variation, subanalyses were carried out for each sentence, independently. These were one-way analyses of variance on the Meanings factor, and served to identify item subgroups within the set of exemplars of a given ambiguity type and word order.

The data analyses to be reported were undertaken separately for each word order variant of each ambiguity type. As Section 4.3 has made clear, very different questions about the impact of Scrambling on processing arise for different word orders in the different ambiguity types. In this initial exploratory study, therefore, the materials design is best viewed as an assemblage of situations that can throw light on questions of the processing of scrambled structures, and the formal statistical analysis is pitched at this level.

## Results and Discussion

For globally ambiguous sentences of the NOM/ACC type, data summarizing the accessibility ratings given to paraphrases of each of two competing meanings<sup>15</sup> are presented in Table 6.6 below:

---

<sup>14</sup> The third term of the analysis of variance, the main effect of Sentences, holds no particular interest in this study. That term picks up differences *among sentences* of a given type and order in the *average* rating given to its paraphrases. Variability here (signalled by statistical significance) is most likely to reflect the variety of grammatical and lexical means used to ensure that paraphrases gave unambiguous expression of the competing meanings of experimental sentences.

<sup>15</sup> Data for Below the Verb and Sentence-Initial variants of the NOM/ACC ambiguity are based on five sentences only, due to a construction error in the preparation of the questionnaire.

**Table 6. NOM/ACC Ambiguity: Rated Accessibility, as a function of Meaning and Word Order**

|                                           | Meaning 1<br>(OBJECT) | Meaning 2<br>(SUBJECT) |
|-------------------------------------------|-----------------------|------------------------|
| <b>Word Order Variant</b>                 |                       |                        |
| BELOW THE VERB                            | 2.68                  | 1.25                   |
| ABOVE THE VERB                            | 2.36                  | 1.70                   |
| SENTENCE-INITIAL                          | 1.27                  | 2.52                   |
| <b>Scale: 0 = No such meaning</b>         |                       |                        |
| <b>3 = Immediately accessible meaning</b> |                       |                        |

For the word order variant locating the second of two DPs ambiguously marked NOM/ACC below the verb, these data showed a strong main effect of Meanings,  $F(1,80) = 94.22$ ,  $p < .001$ , and no reliable interaction of Meanings and Sentences,  $F(4,80) = 1.37$ ,  $p > .25$ . Meaning 1, taking that second DP as object of the verb, was given reliably higher accessibility ratings than its competitor, and this pattern held over exemplars. This outcome is not at all surprising: Meaning 1 supposes the sentence to be in canonical order, while Meaning 2 requires postulation of two scrambling chains, in violation of the Minimal Chain Principle, and processing steps involving reanalysis, in violation of the Minimal Revisions Principle.

The remaining two word order variants, Above the Verb and Sentence-Initial, place the two DPs ambiguously marked NOM/ACC adjacently, and differ only in the order of those DPs. Patterns of meaning preference for these word order variants are expected, therefore, to be mirror-image. Given the assumption of understanding SVO order in Russian (see Section 2.2), either of the two meanings involves scrambled structures, and the parameterized theory of landing sites adopted in this dissertation makes a clear prediction about which of two meanings should be most accessible: This will be the meaning which takes DPs in the order of their encounter, assigning these as subject and object, respectively. Thus, for Above the Verb word order, Meaning 1 requiring postulation of a chain at the second DP, adjoining to VP, should be

preferred to Meaning 2 requiring revision and a longer chain at the first DP, adjoining to IP; Sentence-Initial word order necessarily runs the prediction of preferred meaning in reverse. As discussed in Section 4.3, a theory restricting adjunction to IP only makes less clear predictions, since covert as well as overt scrambling chains are at issue.

Inspection of the data in Table 6.6 for these two word orders suggests that the predicted mirror-image pattern in fact holds, but also that an asymmetry in rated meaning accessibility is greater for the Sentence-Initial than for the Above the Verb word order variant. The statistical analyses in some ways confirmed these impressions: certainly, the Meanings main effect was reliable both for sentences in Above the Verb order  $F(1, 96) = 17.17, p < .001$ , where Meaning 1 received higher overall accessibility ratings, and for sentences in Sentence-Initial order,  $F(1, 80) = 76.24, p < .001$ , where Meaning 2 was favored. However in the data for both word orders there was evidence of variability among the sentences tested; Meanings  $\times$  Sentences interaction approached significance for Above the Verb word order,  $F(5, 96) = 2.22, p < .059$ , and reached significance for Sentence-Initial word order,  $F(4, 80) = 14.60, p < .001$ . Subanalyses showed that, with the critical DP located above the verb, the preference for Meaning 1 was significant by individual test only for three sentences, the remaining three showing no reliable preference either way; with the critical DP located sentence-initially, individual tests found higher Meaning 2 ratings for four sentences only, the remaining one reversing this pattern.

Why are the data less clear, here, than might have been expected? In both word orders, the MCP has to choose between a shorter chain (VP-adjunction of the scrambled object) and a longer chain (IP-adjunction of the scrambled object). Assuming that the MCP does take into account chain lengths, the Minimal Revisions Principle conspires together with the MCP in favoring Meaning 1 in Above the Verb word order but Meaning 2 in Sentence-Initial word order. However, non-structural factors may influence the preference patterns; recall that in materials construction, every effort was made to refine experimental sentences so that its two possible meanings were equally plausible. There was, however, no formal assessment made of

plausibility, the experimenter's native intuition serving as the only guide. It is possible that such factors as relative plausibility of meanings which goes against initial structural preferences in such sentences make the results less clear than expected.

In summary: The results are consistent with the claim that the canonical surface word order in Russian is SVO and that the parser obeys the MCP. Subjects have at the very least a strong tendency to take the first appropriately Case-marked DP in the input to be the subject, in all three word orders. This has been observed also in English (Fodor, Bever, and Garrett, 1974), and in German (Bader, 1994) which also have canonical subject-before-object order. The first DP is taken as the subject and no chain is required; taking it as the object would necessitate postulation of a chain resulting from object Scrambling, a violation of the MCP (and supported by the Minimal Revisions Principle). When both Meaning 1 and Meaning 2 involve Scrambling, as in Above the Verb and Sentence-Initial word orders, at least one chain is unavoidable; however, assuming that the MCP takes into account chain length, the Minimal Revisions Principle favors such scrambled structure which does not require revisions. Other factors such as relative plausibility of meanings may however weaken preferences resulting from these two structural principles.

Table 7 below summarizes the ratings data obtained globally ambiguous sentences of the second type, those with INSTR ambiguity:

**Table 7. INSTR Ambiguity: Mean Rated Accessibility, as a Function of Meaning and Word Order**

|                           | Meaning 1<br>(SMALL CLAUSE) | Meaning 2<br>(BY-PHRASE) |
|---------------------------|-----------------------------|--------------------------|
| <b>Word Order Variant</b> |                             |                          |
| BELOW THE VERB            | 2.48                        | 1.61                     |
| ABOVE THE VERB            | 1.90                        | 2.05                     |
| SENTENCE-INITIAL          | 1.52                        | 2.45                     |

For the *Below the Verb* word order variant, these data show that Meaning 1 (small clause) is reliably rated as more accessible than Meaning 2 (*by*-phrase of passive); the main effect of Meanings was significant,  $F(1, 96) = 30.57, p < .001$ , and there was no indication (in the interaction of Meanings and Sentences) that this pattern differs among the six sentences tested,  $F(5, 96) = 1.53, p > .10$ . Granting the working assumption that small clauses of this kind are properly analyzed as arguments, the pattern of meaning preference found here apparently confirms a prediction of Construal theory: Where there is ambiguity in the attachment of a phrase as an argument or an adjunct, argument status is to be preferred.

However, an account in these terms is not supported by the data for *Above the Verb* word order. Although both meanings require construction of a scrambling chain, nothing has changed other than location of the INSTR phrase and the argument vs. Adjunct distinction remains as before. Yet the data show a pattern which is quite different to that for *Below the Verb* word order. With the critical DP scrambled and left-adjoined to VP, rated accessibility does not differ between Meaning 1 and Meaning 2; for the Meanings main effect,  $F < 1$ . Although there was a suggestion of variability in meaning preference among the sentences tested,  $F(5, 96) = 3.40, p < .01$  for the Meanings  $\times$  Sentences interaction term, individual subanalyses showed this to be only minor: There was no significant difference in meaning accessibility for the five of the sentences tested, and the ratings pattern favored Meaning 2 for the remaining sentence.

Clearly, these data for the INSTR ambiguity taken together, raise a real problem: Assume for the moment that more detailed linguistic analysis confirms the assumption of argument status for these small clauses. This being so, Construal theory needs to account for the finding that argument attachment of an XP-scrambled phrase is not preferred to adjunct attachment, in the way that it is for an unscrambled phrase. Alternatively, assume that closer examination leads to an analysis of these small clauses as adjuncts, so that the argument/adjunct distinction is not relevant to the contrast of meanings in these sentences. Again, what (possibly non-structural) factors can account for the shift in meaning preference patterns seen in the data reported here?

Notice that lexical idiosyncracies, e.g., the plausibility with which a verb takes small clause vs. *by*-phrase remains unchanged whether DP-INSTR is in its canonical position or is scrambled, and thus an account in these terms is unlikely to be successful. In the end, the appropriate account of the data may lie in something as simple as the fact that the right outermost position is the most common, for a small clause of any kind in Russian.

Finally, for Sentence-Initial word order, inspection of the data in Table 7 suggests a further shift in the pattern of meaning accessibility ratings for sentences with INSTR ambiguity. Apparently, the preferred meaning is now Meaning 2, taking the critical DP as the agent *by*-phrase of the passive. Indeed, the analysis showed a Meanings main effect,  $F(1, 96) = 29.45$ ,  $p < .001$ . This overall pattern is consistent with a grammatical constraint: Control theory requires the PRO subject of small clause be c-commanded by the subject of the matrix clause. Thus, XP-Scrambling of small clause above the matrix subject should be ruled out, blocking Meaning 1. However, both native intuition and the data found here suggest that the constraint is not absolute. Meaning 1 can still be assigned to sentences with the INSTR phrase in sentence-initial position; the small-clause meaning status is marginal rather than ungrammatical. Note that the mean rating for Meaning 1, 1.52, lies midway in the 0 – 3 range of the rating scale employed in this experiment, well away from Rating 0, “No such meaning exists.” On this point it is relevant that there was even evidence of the variability among experimental sentences. The Meanings  $\times$  Sentences interaction term was significant,  $F(5, 96) = 2.63$ ,  $p < .05$ , and individual subanalyses showed a Meaning 2 preference for five sentences; for the remaining sentence, Meanings 1 and 2 were equally accessible.

In summary: The Below the Verb word order requires no Scrambling for either meaning, and Meaning 1 (argument small clause) is preferred because the Construal principle favors argument over adjunct attachment when both are available. However, this preference is not carried over, as was expected, for Above the Verb word order: While either meaning required postulating a scrambling chain (that is, both meanings were equally complex to construct),

Meaning 1 and Meaning 2 were equally available. Possibly, some non-structural factors such as plausibility of a small clause with a particular verb or even its most common location were responsible for the shift in meaning preference. An even further shift towards preference for Meaning 2 (*by-phrase*) in Sentence-Initial word order can be explained by the fact that a grammatical principle, Control theory, overrides processing principles: Small clauses cannot be scrambled above the matrix subject which results in a violation of the c-commanding relation between the matrix subject and the PRO subject of small clause.

Table 8 presents mean accessibility ratings for the paraphrases expressing Meaning 1 (indirect object of the embedded verb) and Meaning 2 (subject of the matrix verb) of sentences with the DAT ambiguity:

**Table 8. DAT Ambiguity: Mean Rated Accessibility, as a Function of Meaning and Word Order**

| Word Order Variant | Meaning 1<br>(EMBEDDED<br>OBJECT) | Meaning 2<br>(MATRIX SUBJECT) |
|--------------------|-----------------------------------|-------------------------------|
| BELOW THE VERB     | 2.67                              | 1.06                          |
| ABOVE THE VERB     | 2.01                              | 1.90                          |
| SENTENCE-INITIAL   | 1.75                              | 2.14                          |

For the Below the Verb word order, Meaning 1 was rated as more accessible than Meaning 2, and this pattern was consistent over sentences; for the Meanings main effect,  $F(1, 96) = 117.68$ ,  $p < .001$ ; for the Meanings  $\times$  Sentences interaction,  $F(5, 96) = 1.36$ ,  $p > .10$ . This outcome is not at all surprising, and is predicted by both Right Association and the MCP. Meaning 1 can be constructed directly from the D-Structure of a sentence, without any Scrambling, while Meaning 2 requires postulating a Long-Distance Scrambling chain in which the DAT subject of the matrix clause is moved and VP-adjoined in the embedded clause. Meaning 2 is at best marginal, as the data in Table 8 show; the average rating obtained indicates that subjects were prepared to agree that the meaning is possible, but not one that comes to mind easily.

There is no difference in accessibility between Meaning 1 and Meaning 2,  $F < 1$ . For the Above the Verb word order, postulation of a Scrambling chain is unavoidable in both cases: Meaning 1 requires leftward XP-Scrambling of the indirect object while Meaning 2 requires rightward XP-Scrambling of the matrix subject (Right Extraposition). The chains are comparable in length and differ only in the direction. Thus the lack of an accessibility difference supports the claim that Scrambling is bidirectional in Russian. The pattern of preferred meaning varied across the sentences tested,  $F(5, 96) = 10.78$ ,  $p < .001$  for the interaction term of Meanings x Sentences. Individual subanalyses showed a rating pattern favoring Meaning 1 for two of the sentences tested, Meaning 2 for two other sentences, and no preference either way for those two remaining.

Finally, for the Sentence-Initial word order, it is Meaning 2 which can be constructed directly from the D-Structure of a sentence and involves no Scrambling, while Meaning 1 requires postulating a Long-Distance Scrambling; the DAT indirect object would have to move across two IPs in order to adjoin to the left of the matrix IP. On these grounds, it can be said that this word order straightforwardly reverses the circumstances of Below the Verb word order, for which a very sharp contrast of meaning accessibility was found. And indeed, there was an overall tendency for Meaning 2 to be more accessible than Meaning 1,  $F(1,96) = 5.55$ ,  $p < .025$ . But as inspection of the data in Table 8 suggests, the preference for Meaning 2 is not a strong one, and the analysis showed that it was not consistent over sentences; for the interaction of Meanings x Sentences,  $F(5,96) = 5.91$ ,  $p < .001$ . Subanalyses showed that only two sentences reliably favored Meaning 2; for three sentences, the individual tests provided no evidence for any preference between meanings, while for the remaining sentence the pattern reversed, so that Meaning 1 was favored.

Why are the data not as clear as predicted? When the DP-DAT is scrambled for either of the meanings, as in Above the Verb word order, the parser has to choose between two chains which are of approximately the same length but differ in direction of Scrambling. The MCP does not say anything in terms whether there should be any structural preference reflecting this

difference. It is possible that if the grammar favors leftward movement which is universally the case across languages, the bias would be towards Meaning 1 which is result of the object Scrambling to the left IP-adjoined position of the embedded clause. As for Sentence-Initial word order, much weaker results (the mirror-image of Below the Verb word order) may be due to yet another processing constraint, a constraint against non-transparent use of Case. In the strictly incremental processing, the DP-DAT is assumed to be a scrambled indirect object since DAT is a default Case for indirect objects in Russian; DAT subjects being rare and limited to a very small class of modal predicates. When the conflict between the MCP and non-transparency is revised in favor of the MCP one word later, it has already contributed to a much weaker preference of Meaning 2 than it was expected if a violation of the MCP had been avoided initially.

In sum, the subjects strongly preferred to interpret ambiguous DAT phrase as the indirect object of the embedded verb (Meaning 1) in Below the Verb word order, as was predicted by the MCP and Minimal Revisions, since Meaning 1 involves no Scrambling; constructing Meaning 2 (the subject of the matrix clause) would involve a Long-Distance rightward chain. The results were not so clear for Above the Verb word order, where no difference in accessibility was found. This is compatible with the fact that either meaning would require postulating a scrambling chain, making them both equally complex to construct. However, the data showed a slight bias towards Meaning 2 making it possible to suggest that while both left- and rightward Scrambling is allowed in Russian, leftward XP-Scrambling is the unmarked case. For Sentence-Initial word order, the mirror-image of Below the Verb word order was achieved, as predicted; however, the effect was much weaker in the former case. This was possibly due to the competition between processing principles, the MCP and non-transparent use of Case: XP-Scrambling could be initially preferred under strictly incremental fashion in which the parser proceeds; however, this initial decision very soon is revised, and the DAT subject interpretation becomes available.

## General Discussion

Overall, the findings obtained in Experiment 1's meaning accessibility ratings for sentences presented in a written questionnaire are consistent with the Scrambling Complexity Hypothesis. Details to one side, it can be said that subjects disprefer scrambling constructions. They favor an analysis that requires no XP-Scrambling, i.e., a canonical surface SVO word order, when one exists. This was the case with Below the Verb word order for the NOM/ACC ambiguity (XP-Scrambling) and the DAT ambiguity (LD-Scrambling), and also for Sentence-Initial word order for the INSTR ambiguity. Note for this latter case, however, that a grammatical constraint is involved.

For some sentences, postulating a scrambling chain was unavoidable. This is so for Above the Verb word order for all three ambiguity types (and Sentence-Initial word order for INSTR). In these cases the Scrambling Complexity Hypothesis does not predict any preference, though it is compatible with there being other factors that play a crucial role in meaning accessibility. For INSTR and DAT, the relevant factor may be not a difference of complexity of chains, but lexical factors such as plausibility, and the most common word order for a particular scrambling construction.

Finally, the accessibility of Meaning 2 in the Sentence-Initial variant for INSTR has a potential grammatical explanation. The small clause needs a controlled PRO subject and it must not c-command its controller. Scrambling of the small clause to the left-adjoined position of IP from which it now may c-command the PRO subject of the small clause creates a violation of the Control Theory. In contrast, the adjunct *by*-phrase of the passive is not restricted in this way because it contains no anaphor, and so it can scramble freely.

Thus, the results of Experiment 1 provide support for the following theoretical predictions discussed in Section 4.3.4 above. The Minimal Chain Principle and the Minimal Revisions Principle direct the parser to construct underlying unscrambled structures when both scrambled and unscrambled structures are possible. All other factors being equal, a least complex

structure, without Scrambling, is preferred (unless the sentence contains specific evidence to the contrary). The MCP which takes into account chain length, and the parameters for XP-Scrambling in Russian which allows both left and right IP- and VP-adjunction allow the parser to choose among more complex structures: out of two structures with Scrambling, the one that involves fewer or shorter scrambling chains is preferred. The Construal principle requires the parser to prefer argument over adjunct attachment when both are possible; however, this processing principle can be overridden by a grammatical constraint of the Control theory.

In addition, the results of Experiment 1 shed light on the linguistic analysis of Russian, by choosing between competing accounts of the landing sites and directionality for XP-Scrambling in Russian. The results are better explained by the parameterized theory of landing sites for scrambled phrases, with the assumption that in Russian the parameter is set to make both IP and VP available for adjunction, rather than IP alone. Another finding that is of theoretical linguistic interest is that the data are consistent with the bidirectionality of XP-Scrambling, in contrast to a theory permitting leftward movement analysis only.

#### 4.5 Experiment 2: Whole Sentence Reading Time

Experiment 2 gathered reading time data (and answers to follow-up comprehension questions) for the three types of Russian globally ambiguous sentences, using a whole-sentence reading technique. While Experiment 2 utilized the materials of Experiment 1 (with some modifications), it differed from Experiment 1 in a number of ways.

Experiment 1 gathered judgment data for paraphrases of sentences in each of three word orders, Below the Verb, Above the Verb, and Sentence-Initial, for each of three ambiguity types, NOM/ACC, INSTR, and DAT. These ratings of meaning accessibility were collected separately for each of two paraphrases of any experimental sentence. An imbalance between accessibility ratings for a given sentence provided evidence of a preferred interpretation of the global

ambiguity, that preference usually being related by the structural properties of the competing interpretations. In contrast, Experiment 2 takes as its primary data a reading time measure which is assumed to be related to the time taken to compute one single successful interpretation of an ambiguous sentence; the reading time measure is not itself directly informative about which one of two competing interpretations might have been computed. According to the Minimal Everything strategy of the Garden-Path model, the interpretation which is likely to emerge first, successfully, is the computationally simpler one. Thus, while the data analysis for Experiment 1 looked at the balance of rated accessibility judgments for a given word order, within an ambiguity type, the data analysis for Experiment 2 will compare the reading time for a sentence in one word order with its reading time in another word order. The secondary data collected in Experiment 2, in responses to comprehension questions, are more similar to the data gathered in Experiment 1. Yet even for this task, there could be only one comprehension question (directed toward one interpretation) for any stimulus sentence, and again it will be an analysis across word orders which examines the pattern of interpretative preference.

While Experiment 2 utilizes modified materials from Experiment 1, they are not a proper subset of the latter. The number of experimental sentences was doubled, that is, half the sentences were entirely new (NOM/ACC sentences 7-14, DAT sentences 19-24, and INSTR sentences 31-36, see Appendix 2). The remaining half was modified in terms of length; sentences were shortened in order to fit on no more than two lines on the computer display screen. Moreover, Experiment 2 uses only two word order variants instead of the three used in Experiment 1; these being Below the Verb and Above the Verb variants for NOM/ACC, and below the Verb and Sentence-Initial variants for INSTR and DAT.

These changes from Experiment 1 to Experiment 2 were necessitated by the on-line nature of the latter. It has been argued that Experiment 1's findings are consistent with the principles of the Garden-Path theory, in particular, the MCP and the Minimal Revisions Principle. Experiment 2 was designed to find out whether there is a directly measurable processing cost

associated with XP-Scrambling in Russian, that is, whether the Scrambling Complexity hypothesis can be supported.

### Method

*Subjects.* Forty-four volunteer subjects participated successfully in this experiment, 22 in each of its two versions. All were college-educated native speakers of Russian living in Moscow at the time of testing, who were naive with respect to the purpose of the experiment. Typically, subjects took about 20 minutes to complete the experiment.

*Materials and Design.* Sentence materials for the on-line experiment were based on a subset of the stimulus types used in Experiment 1; only two of the original word orders were included. These were Below the Verb and Above the Verb word order variants for NOM/ACC, but Below the Verb and Sentence-Initial variants of the INSTR and DAT ambiguity types. Half of the experimental items were sentences drawn from Experiment 1 which had been modified to fit the whole sentence reading technique; these were shortened so that they occupied no more than two display lines on the computer screen. The remaining half of the experimental items was a completely new set of sentences designed around the same three ambiguity types.

The globally ambiguous experimental sentences were constructed in pairs. Within a pair, sentences differed only in the location of the Case-marked critical element; one member of the pair placed the critical DP below the verb, and the other, above the verb (NOM/ACC), or in fact sentence-initially (INSTR, DAT). For each of three the NOM/ACC, INSTR, and DAT ambiguity types, 12 pairs of sentences were generated, resulting in a materials set of 72 experimental sentences, in total. In Sections 4.3 and 4.4, the relevant linguistic analyses and off-line processing profiles of the experimental sentences have already been presented; examples (36)-(38) below illustrate experimental materials for Experiment 2:

- (36) a. Trolleybus                      obognal                      *avtobus.*                      BELOW THE VERB  
trolleybus-NOM/ACC              passed                      bus-NOM/ACC
- b. Trolleybus                      *avtobus*                      obognal.                      ABOVE THE VERB  
trolleybus-NOM/ACC              bus-NOM/ACC              obognal

MEANING 1 (OBJECT): 'The trolleybus passed *the bus*.'

MEANING 2 (SUBJECT): 'The *bus* passed the trolleybus.'

- (37) a. Smirnov                      byl poslan                      na zavod                      *direktorom.*                      BELOW THE VERB  
Smirnov-NOM                      was sent                      to the plant                      director-INSTR
- b. *Direktorom*                      Smirnov                      byl poslan                      na zavod.                      SENTENCE-INITIAL  
director-INSTR                      Smirnov                      was sent                      to the plant.

MEANING 1 (SMALL CLAUSE): 'Smirnov was sent to the plant *as a director*.'

MEANING 2 (BY-PHRASE): 'Smirnov was sent to the plant *by the director*.'

- (38) a. PRIXODITSJA                      ob"jasnjať                      principy                      *prepodavateljam.*                      BELOW THE VERB  
have to                      to explain                      principles                      instructors-DAT
- b. Prepodavateljam                      prixoditsja                      ob"jasnjať                      principy.                      SENTENCE-INITIAL  
instructors-DAT                      have to                      to explain                      principles.

MEANING 1 (EMBEDDED OBJECT): '*pro* have to explain the principles to *the instructors*.'

MEANING 2 (MATRIX SUBJECT): '*The instructors* have to explain the principles.'

As in Experiment 1, sentences in Experiment 2 were not controlled for length. Sentences of the NOM/ACC ambiguity type were the shortest (23 characters on average), while sentences with the INSTR and DAT ambiguities were substantially longer (averaging 67 and 59 characters, respectively), with some variability among items.

For each pair of experimental sentences, one comprehension question was constructed. Different grammatical and lexical means were used to ensure that those questions were unambiguous, cf. the unambiguous paraphrases of Experiment 1. All questions were of the Yes/No type, and each was explicitly designed to query one of the two potential meanings of the experimental sentence pairs with which it was associated: A question directed towards Meaning 1 would be answered positively, that is, with a 'Yes' response, just in case the subject had settled on that interpretation of the experimental sentence; conversely, for a question directed towards

Meaning 2. Examples (39)–(41) give the questions actually used for the experimental sentences listed in (36)–(38) above, respectively. Note that (39) is directed to Meaning 2, while (40)–(41) are directed to Meaning 1:<sup>16</sup>

- |      |                                                                                                                                                                                        |                                              |
|------|----------------------------------------------------------------------------------------------------------------------------------------------------------------------------------------|----------------------------------------------|
| (39) | Avtobus    bystree    trolleybusa?<br>bus-NOM    faster    trolleybus-GEN<br>'Is the bus faster than the trolleybus?'                                                                  | MEANING 2 (SUBJECT)<br>NOM/ACC AMBIGUITY     |
| (40) | Smirnova    poslali    na zavod    direktorom?<br>Smirnov-ACC    sent-PL    to the plant    director-INSTR<br>'Did <i>pro</i> send Smirnov to the plant as a director?'                | MEANING 1 (SMALL CLAUSE)<br>INSTR AMBIGUITY  |
| (41) | Prepodavateljam    ob"jasnjajut    principy    trgovli?<br>instructors-DAT    explain-PL    principles    commerce<br>'Do they explain the principles of commerce to the instructors?' | MEANING 1 (EMBEDDED OBJECT)<br>DAT AMBIGUITY |

Half of the comprehension questions constructed for the 12 sentences of each ambiguity type, were Meaning 1 directed, and half were Meaning 2 directed. Appendix 2 lists the set of experimental sentence pairs and their associated questions, in full.

In addition to the experimental sentences described above, 34 globally ambiguous fillers were constructed, each with only one word order. These exhibited other types of ambiguity than the experimental sentences. Eight out of these fillers had ambiguous attachment of a relative clause within a complex DP, as illustrated in (42a), and six had a subject/object ambiguity within a complex DP, as shown in (43a). The remaining 18 sentences had different kinds of adverb, PP, and modifier attachment ambiguity. Just as for experimental sentences, each filler was also

<sup>16</sup> Since only one question was constructed for each pair of experimental sentences, real examples from Experiment 2 materials are not available for questions directed to the alternative meaning of sentences (36)–(38). Below, I illustrate the form that would have been taken in a Meaning 1 directed question for NOM/ACC (36), and in Meaning 2 directed question for INSTR (37) and DAT (38):

- |       |                                                                                                                                                                             |                                             |
|-------|-----------------------------------------------------------------------------------------------------------------------------------------------------------------------------|---------------------------------------------|
| (i)   | Trolleybus    bystree    avtobusa?<br>trolleybus-NOM    faster    bus-GEN<br>'Is the bus faster than the trolleybus?'                                                       | MEANING 1 (OBJECT)<br>NOM/ACC AMBIGUITY     |
| (ii)  | Direktor    poslal    Smirnova    na zavod?<br>director-NOM sent    Smirnov-GEN    to the plant<br>'Did the director send Smirnov to the plant?'                            | MEANING 2 (BY-PHRASE)<br>INSTR AMBIGUITY    |
| (iii) | Prepodavатели    ob"jasnjali    principy    trgovli?<br>instructors-NOM    explained    principles    commerce<br>'Did the instructors explain the principles of commerce?' | MEANING 2 (MATRIX SUBJECT)<br>DAT AMBIGUITY |

followed by a comprehension question unambiguously directed to one of its two possible meanings; (42b) and (43b) are illustrative, cf. (34) and (35) above. Where there were multiple examples of a particular structural ambiguity among the fillers, care was taken to balance the comprehension questions; half were directed to one possible meaning, and half to the other.

- (42) a. *Etu knigu ja vzjal u podrugi moej sestry, nedavno uexavšej za granicu.*  
 this book I took from friend-GEN my sister-GEN recently gone abroad
- b. *Podruga nedavno uexala za granicu?* EARLY CLOSURE MEANING  
 friend-NOM recently has gone abroad  
 'Has the friend recently gone abroad?'
- (43) a. *Obvinenie direktora bylo neobosnovannym.*  
 accusations-NOM director-GEN were ungrounded.
- b. *Direktor obvinjal neobosnovanno?* SUBJECT MEANING  
 director-NOM accused without grounds  
 'Did the director accuse without grounds?'

The experimental and filler items (an item constituting a sentence plus its associated comprehension question) were assembled to create an experiment in two versions. So that identical materials would not be presented twice to any subject, the experimental sentences of any word order pair were assigned to the two versions in a counterbalanced design. Each version of the experiment presented half of the items for an ambiguity type in Below the Verb word order, and half in the alternative order (Above the Verb word order for NOM/ACC, Sentence-Initial word order for INSTR and DAT). Thus, any one version of the experiment presented 70 sentence-plus-question pairs in total, 36 experimental (3 ambiguity types x 2 word orders x 6 exemplars) and 34 filler items. Experimental and filler items were interspersed in a pseudorandom order, a separate pseudorandomization being prepared for each subject. In addition, five practice items were constructed to precede the experiment proper.

Due to screen-size limitations, only 64 characters could fit on a display line. This presented no problem for short NOM/ACC sentences or for comprehension questions, and these could be presented on a single line. However, among the longer INSTR and DAT materials were some sentences which could not be fit on one line of display. For the purposes of presentation,

sentences of these ambiguity types longer than 64 characters were split so as to be displayed on no more than two lines. Sentences were carefully checked to make sure that the line-break occurred at a phrase boundary. In Appendix 2, the symbol “// ” indicates the location of any line-break in an experimental sentence. Note that splitting long sentences between lines affected the location at which the critical INSTR- or DAT-marked phrase was displayed in Below the Verb word order: In six INSTR sentences which were split between the lines, the INSTR phrase occurred on the second line, but in six split DAT sentences, the DAT phrase was only once on the second line. As for fillers, 18 out of 34 were split into two lines, and 2 were split into three lines.

*Procedure.* Subjects were tested individually, in a quiet location, with a procedure which involved two tasks: A sentence was presented as a whole, to be read as quickly as possible, and each sentence was followed by a comprehension question. Materials were presented on the liquid-crystal screen of a notebook computer in a specially designed simplified Cyrillic font<sup>17</sup>, as white letters on a gray background. Each sentence and question was centered on the screen, with questions replacing their associated sentences as soon as subjects responded in the sentence reading task. Stimulus presentation and data collection were under the control of DMASTR software (Forster and Forster, 1990).

Subjects initiated each item's presentation by pressing a footswitch. After the footswitch press, a sentence was displayed as a whole. Whenever the sentence was presented on a single display line or split between lines, the entire sentence was displayed at the same time. The subject was instructed to press either of the two response buttons labeled *ДА* ('YES') and *НЕТ* ('NO') to indicate that the sentence had been read. Display was response-contingent, i.e., the sentence remained on the screen until the subject pressed a response button to signal that it had been read, at which time the sentence was erased and immediately replaced by a comprehension question. "Timeout" for sentence display was set at 9 seconds; that is, the display was

---

<sup>17</sup> It was an appropriately modified version of Borland's "Simplex" font. While it was rather unattractive looking, it was perfectly legible, and the subjects had no problems reading it.

automatically terminated (and a question shown) if no button press had been registered. For the two-choice comprehension task which followed sentence reading, subjects indicated their answer to the question by pressing the appropriate one of the same two response buttons. Timeout for questions was set at 9 seconds.

Subjects were instructed verbally about the character of the tasks they were to perform. They would be reading Russian sentences which would appear on the screen as a whole, and after each sentence was read, they should press either of two response buttons as soon as possible but without sacrificing comprehension. When a question appeared on the screen following the sentence they had just read, they should answer the question by pressing the 'Yes' or 'No' button, as appropriate. Again, they were asked to do this as quickly and as accurately as possible. These instructions were reinforced on the screen before the experiment itself began.

*Data Treatment.* In total, 49 subjects participated in the experiment, and later they were screened according to their performance data. Subjects who had an unacceptable rate of timeouts, i.e., no response given within 9 seconds of the onset of sentence display, were rejected. The cutoff for acceptable performance was set as 10% or more of the data lost, i.e., more than 3 out of 36 experimental sentences. This was taken as an indication that the subject was not just reading normally but had stopped to think about the sentence, thereby jeopardizing the on-line nature of the experiment. Five subjects were rejected on this criterion, and the analyses that follow are based on the remaining successful 44 subjects.

Two kinds of data were collected, corresponding to the two tasks (sentence reading, question answering) which subjects performed in the experiment. Of these, the data for sentence reading are primary, since the experiment was designed to test the Scrambling Hypothesis through the direct comparison of overall reading times for sentences in different word orders. Comprehension questions were included in the first instance simply to ensure that experimental sentences would be read fully. However, these are also a source of data, namely the patterns of

meaning preference indicated by subjects' responses to questions designed to query one of two possible meanings of the globally ambiguous sentences. Both data types were analyzed.

The sentence reading data were analyzed with analyses of variance, the analyses being carried out over reading times and over timeout rates, for each of the three ambiguity types separately. These analyses applied to subject-based data (collapsing over items) and to item-based data (collapsing over subjects), and these different bases of estimation are indicated in the report that follows as  $F_1$  and  $F_2$ , respectively.<sup>18</sup> The factor of interest in the analyses of variance was Word Order, contrasting performance with two word orders; the analyses also included a dummy factor Groups (subject groups in the subject-based analysis, item groups in the item-based analysis) arising from the experiment's two-version design. Prior to the statistical analysis, standard data cleanup routines were applied to the reading time data. Responses shorter than 250 ms or longer than 3000 ms were discarded as anticipatory or aberrant, respectively; then, to minimize the distorting effect of outliers, data points lying beyond cutoffs set for each subject at mean plus-or-minus two standard deviations were replaced by those cutoff values.

The analysis of question-answering data was based on assumptions whose justification comes from the way questions were constructed to be directed towards a particular meaning of an ambiguous sentence. A positive response ('Yes') to a question querying, say, Meaning 1, was taken to indicate that the subject had accepted that meaning, and a negative response was taken to indicate that the subject had instead settled on the alternative, say, Meaning 2. Given these assumptions, the patterns of Yes/No answers can provide information about which meaning was preferred, regardless of the way questions were cast. For the purposes of analysis, the data were transformed to reflect the rate of acceptance of Meaning 1. Analyses of variance were carried out on subject- and item-based data, for each ambiguity type separately, as for the sentence reading data. Again, these had a dummy factor (Groups) in addition to the Word Order factor which is of

---

<sup>18</sup> F values were combined in the *minF'* statistic; since this is known to be conservative, an alpha-level of 10% is accepted for significance (Santa, Miller, and Shaw, 1979). When *minF'* fails to reach significance,  $F_1$  and  $F_2$  are reported individually.

interest, but they also included a third factor, Question Form, through which the assumptions on which the analysis rested could be checked. No main effect of Question Form emerged in any analyses, nor any interaction with Word Order, and this factor is therefore omitted in the report of results.

### Results and Discussion

For the NOM/ACC ambiguity, data collected in the sentence reading and post-sentence comprehension tasks are summarized in Table 9. Note that, for the latter, the table shows not only the rates at which Meaning 1 was accepted in question responses (i.e., the data entered into statistical analyses), but also the rates at which Meaning 2 was accepted.<sup>19</sup> This is intended to facilitate the comparison with Experiment 1's data patterns.

**Table 9. NOM/ACC Ambiguity: Sentence Reading Time (in seconds, percent timeouts in parentheses) and Question Response Preference (percent) as a function of Word Order**

| WORD ORDER     | SENTENCE<br>READING TIME | RESPONSE PREFERENCE   |                        |
|----------------|--------------------------|-----------------------|------------------------|
|                |                          | Meaning 1<br>(OBJECT) | Meaning 2<br>(SUBJECT) |
| Below the Verb | 2.80 (0.4)               | 73.5                  | 25.0                   |
| Above the Verb | 3.27 (1.5)               | 64.1                  | 34.1                   |

As the data in the left panel of Table 9 show, it took subjects longer to read NOM/ACC sentences in Above the Verb word order than in Below the Verb word order, the difference being 0.47 sec. The data analysis found that this lengthening of reading times was reliable,  $\min F'(1,17) = 11.51, p < .005$ . The rate at which timeouts occurred follows the reading time data,

<sup>19</sup> Meaning 1 and Meaning 2 percentages for each word order sum to a little less than 100%, reflecting the small proportion of occasions on which no answer had been registered within 9 seconds of the onset of question display.

being numerically greater for Above the Verb word order, but because timeouts were so few with these very short sentences, the difference between word orders failed to reach significance,  $F_1(1,42) = 3.10, .05 < p < .10, F_2(1,10) = 2.14, p > .10$ .

These results provide evidence in support of the Scrambling Complexity Hypothesis. Recall that for globally ambiguous NOM/ACC sentences in Above the Verb word order, with two Case-ambiguous DPs encountered before the verb, a scrambling analysis is required, whether Meaning 1 or Meaning 2 is adopted (see Section 4.3.1). However, for Below the Verb word order with its ambiguous DPs on either side of the verb, no scrambling is required for one of the two available interpretations, namely, Meaning 1 (and Experiment 1 has shown that this is indeed the strongly preferred interpretation, see Section 4.4). The claim that scrambling constructions are more difficult to process than their unscrambled counterparts therefore predicts that Meaning 2 will rarely be adopted for a sentence in Below the Verb order; this being so, it predicts further that Above the Verb sentences (unavoidably taken as scrambled) will take longer to read than Below the Verb sentences (almost invariably taken as unscrambled) – just as the reading time data have shown, here.

The interpretation placed on the reading time outcome, above, depends crucially on the assumption that Meaning 1 is much more likely than Meaning 2 for sentences in Below the Verb word order. The response preference data arising from Experiment 2's comprehension questions (Table 9, right panel) confirm this assumption: Meaning 1 for the Below the Verb variant (SVO order requiring no Scrambling) was preferred better than 3-to-1 over Meaning 2 (OVS, requiring postulation of two scrambling chains).

Response preferences for the Above the Verb variant do not reflect absence versus presence of Scrambling, but rather the details of the Scrambling analysis involved in the two meanings: Meaning 1 (taking the second-encountered DP as object, SOV) results in a short chain since it supposes the scrambled object to be VP-adjoined; Meaning 2 (taking the second-encountered DP as subject and the first as object, OSV) has a longer chain since it supposes the

scrambled object to be IP-adjoined, and presumably incurs also a violation of the Minimal Revisions Principle since the assignments of subject and object reverses the order in which DPs are encountered. It is therefore not surprising that Meaning 1 appears to be preferred for Above the Verb word order, just as it was for Below the Verb. Equally, the weakening of that preference (so that Meaning 1 was favored somewhat less than 2—to –1 over Meaning 2) is not surprising, given the more subtle basis of competition between meanings when sentences are in non-canonical order. Note the parallel with the findings of Experiment 1 (see Table 6, Section 4.4).

The analysis of response preference data, comparing Meaning 1 acceptance rates between word orders, showed that the decrease in Meaning 1 dominance from Below the Verb to Above the Verb was reliable in the subject-based analysis,  $F_1(1, 42) = 5.85, p < .025$ ; however, it failed to reach significance in the item-based analysis,  $F_1(1, 8) = 3.26, p = .11$ . The generalization is thus not an entirely secure one.

For the INSTR ambiguity, reading time and comprehension question data are summarized in Table 10. Note that, as in Table 9, response preference data are provided for Meaning 2 to facilitate comparison with Experiment 1.

**Table 10. INSTR Ambiguity: Sentence Reading Time (in seconds, percent timeouts in parentheses) and Question Response Preference (percent) as a function of Word Order**

| WORD ORDER       | SENTENCE<br>READING TIME | RESPONSE PREFERENCE         |                          |
|------------------|--------------------------|-----------------------------|--------------------------|
|                  |                          | Reading 1<br>(SMALL CLAUSE) | Reading 2<br>(BY PHRASE) |
| Below the Verb   | 4.42 (1.9)               | 76.2                        | 23.5                     |
| Sentence-Initial | 5.31 (6.4)               | 37.9                        | 61.8                     |

The data in the left panel of Table 10 show that it took subjects longer to read sentences in which the ambiguous INSTR phrase occurred sentence-initially, in comparison to those in which

the critical phrase occurred below the verb, a difference of 0.89 sec which was highly significant,  $minF'(1,20) = 32.51, p < .001$ . The difference in the timeout rates, similarly greater for Sentence-Initial word order, was also significant,  $minF'(1,48) = 3.62, p < .10$ . Again, these results can be interpreted as arguing for an increase in processing load associated with scrambling constructions. For Below the Verb word order, the INSTR phrase can be interpreted either as a small clause or as the agent *by*-phrase of the passive, neither meaning involving Scrambling; however, when that phrase is placed sentence-initially, a Scrambling analysis is unavoidable. Thus, the data for INSTR are compatible with the Scrambling Complexity Hypothesis.

The response preference data in the right panel of Table 10 show that Meaning 1 is strongly preferred over Meaning 2 in Below the Verb word order; the 3—to—1 preference here is not connected to Scrambling, but may be attributable to the argument status assumed for Meaning 1's small clause, cf. adjunct status for Meaning 2's *by*-phrase of the passive. In Above the Verb word order, this preference pattern reverses to favor Meaning 2. While both meanings in Above the Verb word order involve Scrambling, Meaning 1 is more or less unavailable in this variant due to a violation of the Control Theory; see discussion in Section 4.3 above. Meaning 1 is not totally blocked, as shown by the nearly 38% of question responses which accept it. Nonetheless, a small clause scrambled above its antecedent is somewhat marginal compared with Scrambling of the *by*-phrase of the passive, which is perfectly grammatical. Just as was the case with the NOM/ACC ambiguity, the data for INSTR parallel the findings in Experiment 1. The analyses comparing rates at which Meaning 1 was accepted in Below the Verb and Sentence-Initial word orders found a significant shift in pattern,  $minF'(1,22) = 27.26, p < .001$ .

Finally, for the DAT ambiguity, the two data types are summarized in Table 11:

**Table 11. DAT Ambiguity: Sentence Reading Time (in seconds, percent timeouts in parentheses) and Question Response Preference (percent) as a function of Word Order**

| WORD ORDER       | RESPONSE PREFERENCE      |                             |                            |
|------------------|--------------------------|-----------------------------|----------------------------|
|                  | SENTENCE<br>READING TIME | Reading 1<br>(EMBEDDED OBJ) | Reading 2<br>(MATRIX SUBJ) |
| Below the Verb   | 4.28 (0.8)               | 76.6                        | 22.3                       |
| Sentence-Initial | 4.19 (1.1)               | 40.2                        | 59.5                       |

The data in the left panel of Table 11 show that, in contrast to the NOM/ACC and INSTR ambiguity types, reading times for the two different word order variants were remarkably similar. Indeed, sentences in Below the Verb word order differed in reading time from those in Sentence-Initial word order only by 0.09 sec,  $F < 1$  in both subject- and item-based analyses. Nor was there any evidence of a difference in the timeout rates for the two word orders,  $F < 1$  in both analyses. This is not surprising because (unlike the NOM/ACC and INSTR ambiguities) a simple structure without Scrambling is available for each of the word order variants of the DAT ambiguity (Meaning 1 for the Below the Verb variant; Meaning 2 for the Sentence-Initial variant). In accordance with the Scrambling Complexity Hypothesis, structures without Scrambling are universally preferred, and that preferred meaning should incur no special cost for either word order. The lack of any observed difference here strengthens the argument that the reading time differences found for NOM/ACC and INSTR are indeed due to the cost of Scrambling.

The response preference data (right panel, Table 11) show that indeed subjects strongly preferred Meaning 1 for sentences in Below the Verb word order more than 3-to-1 over Meaning 2. This is not surprising given the fact that Meaning 1 requires no Scrambling and can be read off directly from the D-Structure; to assign Meaning 2 to this variant would mean postulating of a rightward Long-Distance scrambling chain. For the Sentence-Initial word order,

it is Meaning 2 which is compatible with a simple structure without Scrambling; constructing Meaning 1 would involve postulating a leftward Long-Distance chain. Although the data show a reversal of pattern, the asymmetry between meanings is numerically smaller: Meaning 2 was preferred over Meaning 1, roughly 3 – to – 2. In Section 4.3.3 it has been suggested that there may be competition between a processing principle, the MCP, and a dispreference for non-transparent use of Case. Thus, XP-Scrambling could be initially preferred if processing is strictly incremental to avoid the oddness of a DAT-marked subject; however, this initial decision very soon would be revised, when the DAT subject interpretation became licensed by a modal predicate. Analyses of Meaning 1 acceptance rates in the two word orders provided evidence of a highly reliable difference,  $\min F'(1,11) = 18.45$ ,  $p < .005$ . These results confirm those obtained for DAT ambiguity sentences in Experiment 1. Subjects most often choose the interpretation which requires minimally necessary structure, i.e., the one without Scrambling.

### General Discussion

The results of Experiment 2 are twofold: First, the sentence reading times were consistent with the Scrambling Complexity Hypothesis; second, subjects' answers to the post-sentential comprehension question data were quite parallel to the meaning accessibility findings of Experiment 1.

Subjects favor a canonical surface SVO word order, and when Scrambling is unavoidable the analysis with a shorter chain is preferred. It is reasonable to suppose that this is because XP-Scrambling imposes an additional burden on the processor and thus is avoided or minimized whenever possible. This interpretation is supported by the fact that when a Scrambling analysis must be adopted, reading time increases.

Overall, the results of Experiment 2 (like the results of Experiment 1) provide support for the theoretical predictions discussed in Section 4.3 above. Russian XP-Scrambling constructions do not require any new additional processing principles, since all the data are compatible with the assumption that they are parsed according to the general strategy Minimal Everything of the Garden-Path theory. Everything else being equal, the least complex structure is preferred, unless there is evidence to the contrary. One instance of this is that structures without Scrambling are preferred where available. Moreover, when two structures with Scrambling compete, the one that involves shorter scrambling chains wins. The MCP and Minimal Revision Principle account for almost all the meaning preferences found in the comprehension question data in this experiment; however, the DAT ambiguity data seem to suggest that there is a processing dispreference for non-transparent use of Case. In general, there is support for the claim that a least-effort tendency in the human parser leads to a processing cost for XP-Scrambling in Russian, as reflected in longer reading times for scrambled word orders.

#### 4.6 Summary of Chapter 4

In this chapter, the processing characteristics of Russian XP-scrambling constructions have been investigated. It has been argued that the findings in the two experimental studies, an off-line meaning accessibility questionnaire and an on-line whole sentence reading experiment involving also comprehension questions, are consistent with the claim that the Garden-Path theory is universal. The MCP and the Minimal Revision Principle which have been proposed as universal principles have been shown to apply to these constructions: Subjects choose interpretations of globally ambiguous Russian sentences which have minimal scrambling chains.

The specific results are as follows. In Experiment 1, subjects gave higher ratings to meanings resulting from analyzing ambiguous sentences as having canonical SVO order, compared with derived orders. In Experiment 2, it took subjects longer to read scrambled

sentences than their unscrambled counterparts. Also, subjects answered questions on the basis of whichever sentence meaning involved no scrambling chains or the fewest and shortest possible. These results all support the Scrambling Complexity Hypothesis.

The results of these two experiments contrast with those in previous investigations of the processing of XP-Scrambling in German and Japanese. As has been reviewed in Sections 4.2.2 - 4.2.3 of this chapter, it has been claimed in the literature for both languages that no extra processing load is incurred by XP-scrambling. Further studies are needed to clarify the exact nature of the differences in processing XP-Scrambling in Russian, on the one hand, and in German and Japanese, on the other hand.

This chapter concludes Part I of this dissertation, whose goal was to investigate the syntactic and processing characteristics of XP-Scrambling in Russian. In addition to the questions it could answer in its own right, this investigation was the first step necessary to explore another and less common type of Scrambling which exists in Russian – Split Scrambling. The syntactic and processing characteristics of split scrambling constructions constitute the topic of Part II of this dissertation.

**PART II: SPLIT SCRAMBLING: SYNTAX AND PROCESSING**

**Chapter 5: Syntactic Properties of Split Scrambling**

|         |                                                                                  |     |
|---------|----------------------------------------------------------------------------------|-----|
| 5.1     | Introduction .....                                                               | 182 |
| 5.2     | Descriptive Properties of Split Scrambling in Russian .....                      | 185 |
| 5.2.1   | Restrictions on Discontinuous DPs and PPs .....                                  | 185 |
| 5.3     | Syntactic Properties of Split Scrambling Cross-Linguistically .....              | 189 |
| 5.3.1   | Historical Overview .....                                                        | 190 |
| 5.3.2   | PP and NP Breakup in Latin (Ostafin, 1986) .....                                 | 193 |
| 5.3.2.1 | PP Breakup .....                                                                 | 194 |
| 5.3.2.2 | NP Breakup .....                                                                 | 196 |
| 5.3.3   | VP-Remnant Topicalization in German (Den Besten and Webelhuth,<br>1990) .....    | 198 |
| 5.3.4   | PP-Remnant Topicalization in Serbo-Croatian (Franks and Progovac,<br>1994) ..... | 199 |
| 5.3.5   | Split DP Focus Constructions in Modern Greek (Androutsopoulou,<br>1997) .....    | 205 |
| 5.4     | Syntactic Accounts of Split Scrambling in Russian .....                          | 207 |
| 5.4.1   | DP-Hypothesis and the <i>Barriers</i> Framework (Yearley, 1993) .....            | 208 |
| 5.4.2   | Scrambling of Pieces of Phrases (Franks, 1993) .....                             | 211 |
| 5.4.3   | DP-Hypothesis, Left Branch Constraint and Subjacency (Bailyn, 1995) .....        | 213 |
| 5.4.4   | Copy and Deletion (Junghanns and Zybatow, 1995) .....                            | 214 |
| 5.4.5   | Summary .....                                                                    | 216 |
| 5.5     | The Double-Movement Analysis of Split Scrambling in Russian .....                | 217 |
| 5.6     | Summary of Chapter 5 .....                                                       | 224 |

## 5.1. Introduction

Regular XP-Scrambling as found in many Indo-European and Asian languages does not exhaust the phenomenon of free word order. Perhaps the most extreme manifestation of this phenomenon is discontinuous constituency of phrases (arguments and adjuncts) such as DPs and PPs. The existence of discontinuous DPs and PPs is one of the most striking typological characteristics of non-configurational languages of which the best known are the Australian Aboriginal languages (Hale, 1983; Austin and Bresnan, 1996) where non-configurationality is a theoretical concept understood to imply a lack of X-bar schemas so that a sentence is generated as an unstructured string of words, that is,  $S \rightarrow W^*$  (Hale, 1983).

The scrambling languages (except Russian) discussed in Part I of this dissertation exhibit relatively free constituent order but do not allow discontinuous DPs and PPs of this type. Note that the issue in question here is discontinuous constituency of non-sentential argument and adjunct phrases. This does not mean that other languages do not allow discontinuous constituency in general. Understood broadly, any type of movement produces discontinuous constituents. For example, Wh-movement of an object in an SVO language like English results in a discontinuous VP. However, in these types of movement, a head of a syntactic phrase and its modifier move together as a whole, so this can be subsumed under the heading of XP-movement. Descriptively, I define *Split Scrambling* as an operation which derives discontinuous DPs and PPs otherwise treated as a unit with respect to Case theory and  $\theta$ -theory. Discontinuous DPs and PPs are phrases in which modifiers are separated from the N head by other constituents, as illustrated in (1) for Russian (the subparts of the discontinuous constituent are underlined):<sup>1</sup>

---

<sup>1</sup> Russian allows any maximal projection smaller than VP to be discontinuous, including AP, AdvP, DP and PP. In example (i), a degree word *očen'* 'very' is separated from the head of the adjectival small clause *ščastlivym* 'happy' it modifies resulting in a discontinuous AP, and (ii) illustrates a split adverbial phrase:

- (i) Očen' Ivan prišel domoj ščastlivym.  
 very Ivan came home happy  
 'Ivan came home very happy.'
- (ii) Sliškom Ivan prišel domoj pozдно.  
 too Ivan came home late

- (1) a. I k polosatym bežit on tigriatam ... (Kornej Čukovskij 'Doctor Ajbolit')  
 and to striped-DAT runs he tiger cubs-DAT  
 'And he is running to the striped tiger cubs ...'
- b. Ox, vetry naleteli zlye! ( a folk song)  
 Oh, winds-NOM came ferocious-NOM  
 'And the ferocious winds came.'

Examples of the type (1) are found in two particular registers of Russian – the language of literature (literary Russian) and spoken (colloquial) Russian.

Split Scrambling can be found in those Indo-European languages which are often described as having discourse-oriented free word order. These contrast with the scrambling languages with more restricted freedom of word order such as the Germanic languages, Japanese, and Hindi, which were discussed in Chapter 2. Classical languages, Latin and Ancient Greek, as well as Modern Greek, on the one hand, and at least some of the Slavic languages such as Serbo-Croatian, Polish, and Russian, on the other, are traditionally analyzed as exhibiting such properties as pragmatically-determined free word order and discontinuous constituency. These two properties justified a line of research (Yearley, 1993) which investigated the question of whether they may be non-configurational languages like Warlpiri. However, the lack of other properties associated with non-configurationality (properties such as no VP constituent, split-ergative case marking and null anaphora) (Austin and Bresnan, 1996), together with detailed analysis of the basic syntactic structure of the clause (Ostafin (1986) for Latin; King (1993) and Bailyn (1995) for Russian), convincingly show that these languages are configurational (see Chapter 2 for discussion of configurationality of Russian).<sup>2</sup>

---

'Ivan came home too late.'

The constructions with discontinuous AP and AdvP (i)-(ii) will not be discussed here any further, and in what follows we will focus specifically on discontinuity in DPs and PPs.

<sup>2</sup> Australian Aboriginal languages and Latin/Greek and Slavic languages have in common a syntactic phenomenon of DP and NP-internal morphological agreement of an adjectival modifier with its head noun. Note that in contrast to Warlpiri, agreement features such as gender, number, and case in Latin and Russian are always obligatory regardless of whether modifying adjectives and the head noun are adjacent or not. In Warlpiri, as the contrast between (ia) and (ib) above shows, this agreement is absent in sentences where modifying adjectives and the head noun are adjacent (ia):

- a. Kurdu wita-jarra-rlu =ka-pala maliki wajili-ni-nyi.  
 child small-DUAL-ERG PRES-3duSUB dog.ABS chase-NPAST

The properties of Split Scrambling, which is the theme of Part II of this dissertation, have been much less thoroughly investigated cross-linguistically than those of regular XP-Scrambling, discussed in Part I. Recently, a few analyses of Split Scrambling in German, Latin, Serbo-Croatian, Modern Greek (Section 5.3), and Polish (Section 6.3) have been proposed in the literature. They are relevant to the Double-Movement analysis for Russian split scrambling constructions argued for in this chapter (Section 5.5). The Double-Movement analysis is compared to four recent attempts to account for discontinuous DPs and PPs in (Section 5.4). While some of the details of the proposed structural derivations will be useful, in general these accounts of Russian (Yearley, 1993; Franks, 1993; Bailyn, 1995; Junghanns and Zybatow, 1995) are still quite sketchy. They do not provide an explanation for the restrictions on Split Scrambling in Russian, and do not address the issue of its motivation.

It is generally assumed that the unmarked word order in the Russian DP is Adjective – Noun where the adjective is continuous with the noun. However, discontinuous orders are quite common both in literary and spoken Russian. The goal of this chapter is to provide a syntactic analysis of split scrambling constructions in Russian. In order to do this, it is important to formulate descriptive generalizations about split scrambling constructions (Section 5.2). The constraints on it appear to be more restrictive than those on XP-Scrambling which allows any XP to undergo Scrambling and can be multiple and possibly long-distance. In contrast, Split Scrambling does not allow phrases with multiple modifiers to be discontinuous, it cannot be long-distance, it obeys a Periphery Constraint, a One-Split-per-Clause Constraint, and for split PPs it obeys a Preposition-First Constraint, combined with the No Preposition Stranding Constraint.

---

'Two small children are chasing the dog.' or  
'Two children are chasing the dog and they are small.'

- b. Kurdu-jarra-rlu =ka-pala maliki wajili-pi-nyi wita-jarra-rlu.  
child-DUAL-ERG PRES-3duSUB dog.ABS chase-NPAST small-DUAL-ERG  
'The two small children are chasing the dog.' (Austin and Bresnan 1996: (25)-(26))

Section 5.5 (and Chapter 6 to follow) presents an attempt to explain these restrictions on Split Scrambling in Russian by means of the Double-Movement analysis. Two parameters are proposed for Russian Split Scrambling:

*Remnant in Situ*: Yes/No;

Category of Extracted Element: N', A'.

Split Scrambling is hypothesized to be an operation which consists of two steps: leftward XP-Scrambling of a DP (or PP) and a rightward Y'-Extraction. First, a DP is XP-scrambled to a special position, the SPEC position of F(ocus)P. Then a phrase which is argued to be a Y' is extracted out of the scrambled DP (or PP) into the right FP-adjoined position. Both movement operations obey the standard constraints on movement. While the Double-Movement analysis of Split Scrambling in Russian faces some unresolved issues, such as justifying the fact that a Y' can move, it provides an explanation for the Periphery Constraint, the One-Split-per-Clause Constraint, and the Preposition-First Constraint.

## 5.2 Descriptive Properties of Split Scrambling in Russian

As was the case with standard XP-Scrambling (Chapter 2), with respect to Split Scrambling there are two important issues that need to be discussed. First, how are split scrambling constructions derived and what is their syntactic structure (Section 5.3)? Second, what motivates Split Scrambling (see Chapter 6)? Like standard XP-Scrambling, it appears to be optional.

### 5.2.1 Restrictions on Discontinuous DPs and PPs

Compared to cases of standard clause-internal XP-Scrambling (Chapter 2), Split Scrambling appears to be more restrictive. Both theoretically possible split word orders are available for Russian discontinuous DPs, as in (2) (in contrast to the asymmetrical pattern Adj ...

N of other languages which allow Split Scrambling; see Section 5.3 below). However, only two out of all theoretically possible split word orders are available for discontinuous PPs, as shown in (3).

- (2) a. Adj ... N  
b. N ... Adj
- (3) a. P Adj ... N  
b. P N ... Adj

Furthermore, an analysis of discontinuous DPs and PPs in Russian reveals that Split Scrambling obeys the following descriptive constraints (4) which are not characteristic of XP-Scrambling.

- (4) (a) Discontinuity within the DP (and PP) tends to involve phrases containing a head noun and just one modifying adjective (or possessive, etc.). In cases where the head noun is modified by more than one adjective<sup>3</sup>, any kind of split appears to be much less acceptable, as shown in (5b, c, d) below, than in cases with a single adjectival modifier (5a).<sup>4</sup>
- (b) Long-Distance Split Scrambling is not allowed, as the ill-formed (6a, b) show, in contrast to XP-Scrambling which while far from being perfect, marginally allows Long-Distance Scrambling in some contexts (6c).<sup>5</sup>
- (c) *The Periphery Constraint*: In the overwhelming majority of cases, the constituents of a phrase are split up into two parts such that one part (a remnant XP) occurs on the left edge of the clause (sentence-initially), while the other (an Y') is moved to the right edge (sentence-finally), as shown in (7a, c). However, since they can appear in other

---

<sup>3</sup> In Russian, nouns can be modified by both prenominal adjectives and postnominal nouns in GEN. Discontinuous usage of these GEN nominal modifiers is also possible in Colloquial Russian but to a lesser degree than discontinuous usage of adjectival modifiers. I will not discuss cases of discontinuous nominal modifiers in this dissertation and leave this topic for future research.

<sup>4</sup> Franks and Progovac (1994) (see Section 5.3.4) analyze similar examples in Serbo-Croatian and argue that when the first modifying adjective is the demonstrative *ovu* 'this' it can be extracted in Serbo-Croatian leaving the second modifying adjective and the head noun behind. This is not possible in comparable constructions in Russian.

<sup>5</sup> In general, long distance extraction in Russian is allowed only across an overt subjunctive complementizer *čtoby* or from infinitival complements.

positions as well, as in (7b, d), although much less frequently, this restriction appears to be a tendency and not an absolute constraint, in contrast to Polish (see Section 6.3) where this constraint is strictly enforced.

- (d) *The One Split-per-Clause Constraint*: Only one split constituent is allowed per clause. Franks' (1993) examples of double splits (8a, b) are considered ungrammatical by the overwhelming majority of Russian speakers<sup>6</sup> while a single split of any DP in the sentence is acceptable.
- (e) *The Preposition-First Constraint*, in combination with the No Preposition Stranding Constraint (for discontinuous PPs only): Discontinuity within the PP can only occur if some part of the prepositional object remains adjacent to the preposition (Ostafin, 1986), and no part of the prepositional object precedes the preposition, as the ill-formed (9a, b, c) illustrate.

- (5) a. On sobral ljubimye semejnye fotografii.  
he collected favorite-ACC family-ACC pictures-ACC
- b. *?\*Ljubimye semejnye on sobral fotografii.* SPLIT DP  
favorite-ACC family-ACC he collected pictures-ACC
- c. *?\*Ljubimye on sobral semejnye fotografii.* SPLIT DP  
favorite-ACC he collected family-ACC pictures-ACC  
'He collected his favorite family pictures.'
- d. *\*?Po novej korotkoj my poedem doroge.* SPLIT PP  
on new-PREP short-PREP we will go road-PREP  
'We will go on the new short road.'
- (6) a. *?\*Beluju ja xotela, čtoby ty nadel rubašku.* SPLIT DP  
white-ACC I would like that-SUBJ you put on shirt-ACC  
'I would like you to put on a white shirt.'
- b. *?\*Po novej Maša poprosila, čtoby my poexali doroge.* SPLIT DP  
on new-PREP Masha asked that-SUBJ we went road-PREP

<sup>6</sup> My judgments are based on informal inquiries with numerous Russian informants, linguists as well as non-linguists. I did not conduct a formal questionnaire study to assess the acceptability of such constructions because the informants were unanimous about the unacceptability of double splits in general.

- c. Po novoj doroge Maša poprosila, čtoby my poexali. XP-SCRAMBLED  
 on new-PREP road-PREP Masha asked that-SUBJ we went  
 'Masha asked that we went on the new road.'
- (7) a. Interesnuju oni predložili moej dočke rabotu. SPLIT DP  
 Interesting-ACC they offered my-DAT daughter-DAT work-ACC  
 b. Oni interesnuju predložili rabotu moej dočke. SPLIT DP  
 they interesting-ACC offered work-ACC my-DAT daughter-DAT  
 'They offered interesting work to my daughter.'  
 c. Po novoj my poexali doroge. SPLIT PP  
 on new-PREP we-NOM went road-PREP  
 d. My po novoj poexali doroge. SPLIT DP  
 we-NOM on new-PREP went road-PREP  
 'We went on the new road.'
- (8) a. \*Interesnuju<sub>1</sub> oni dočke<sub>2</sub> predložili moej<sub>2</sub> rabotu<sub>1</sub>. SPLIT DP  
 Interesting-ACC they-NOM daughter-DAT offered my-DAT work-ACC  
 'They offered interesting work to my daughter.'  
 b. \*Po novoj<sub>1</sub> na letnjuju<sub>2</sub> my poexali daču<sub>2</sub> doroge<sub>1</sub>. SPLIT PP  
 on new-PREP to summer-ACC we went cottage-ACC road-PREP  
 'We went to the summer cottage on the new road.'
- (9) a. \*Novoj my poexali po doroge. SPLIT DP  
 new-PREP we-NOM went on road-PREP  
 b. \*Doroge my poexali po novoj. SPLIT PP  
 road-PREP we-NOM went on new-PREP  
 c. \*Novoj doroge my poexali po.  
 \*new-PREP road-PREP we-NOM went on  
 'We went on the new road.'

The restrictions in (4) are summarized in Table 12:

Table 12. Restrictions on Split Scrambling in Russian

| RESTRICTIONS ON SPLIT SCRAMBLING        | DP EXAMPLE | PP EXAMPLE |
|-----------------------------------------|------------|------------|
| (a) Single modifier only                | (5b, c)    | (5d)       |
| (b) Clause-boundedness                  | (6a)       | (6b)       |
| (c) the Periphery Constraint            | (7a, b)    | (7c, d)    |
| (d) the One-Split-per-Clause Constraint | (8a)       | (8b)       |
| (e) The Preposition-First Constraint    | n/a        | (9a, b, c) |

What is the explanation for the restrictions in Table 12? Since I am only concerned in this dissertation with the cases where there is only one modifying adjective in the DP, I will not be proposing a grammatical explanation for the restriction (4a), i.e., the fact that multiple modifiers do not appear to be extractable. It is possible that the syntactic configuration of the two adjectives inside the DP is such (e.g., two adjunctions) that their extraction together is disallowed.<sup>7</sup> Extraction of multiple modifiers one by one can probably be subsumed under the One-Split-per-Clause Constraint. But why the remnant cannot contain multiple modifiers is quite unclear.

Nor am I dealing with Long-Distance Scrambling (4b) here. As was noted above, Long Distance Scrambling is a marginal phenomenon in Russian grammar, and we need first to find constructions where it would be fully accepted by informants. If such constructions are considered strained in general, then together with the greater complexity of Split Scrambling, this may be sufficient to account for why Split Scrambling does not occur outside of the clause.

The three remaining restrictions, the Periphery Constraint (4c), the One-Split-per-Clause Constraint (4d), and the Preposition-First Constraint (4e), will be addressed here and it will be argued in Section 5.5 and Chapter 6 that the Double-Movement analysis of Split Scrambling in Russian can provide a plausible grammatical explanation for these restrictions. In Chapter 7 a potential processing explanation for these constraints will be considered and will be argued to have some plausibility too, but experimental evidence is in accord with this only for the One-Split-per-Clause Constraint.

### 5.3 Syntactic Properties of Split Scrambling Cross-Linguistically

It is surprising how little has been written about discontinuous constituency in generative syntax. The reason probably lies in the fact that for a long time, generative syntax concerned

---

<sup>7</sup> Notice that Siewierska (1984) (see Section 6.3, Chapter 6 below) does not explicitly discuss the source for this restriction in Polish either. She considers it most probably to be a part of the processing considerations which limit Polish clauses with split constituents to very short and simple ones.

itself primarily with English data. English has a very limited set of discontinuous constituency constructions (Wh-Movement, Topicalization, Extraposition, Preposition Stranding) and no discontinuous DPs in which an adjective is separated from the N head it modifies by other constituents. A volume of papers edited by Huck and Ojeda (1987) contains studies of different movement phenomena in English which produce discontinuity within the VP. The set of these movement phenomena in English is rather diverse; constructions in which such movements occur include degree words and their complements, verb plus particle constructions, extraposition out of NP, PP, extraposition of relative clause, Right-Node Raising constructions, adverb placement, Stripping, comparatives, and gapping. Note that these constructions are quite different from discontinuous DPs and PPs, illustrated in (1) above for Russian, and the analyses proposed to account for the English discontinuous VP constructions in the Huck and Ojeda (1987) volume appear not to be relevant to the Russian facts, either directly, or by adaptation.

There are other languages to which Russian is genealogically related which exhibit the phenomenon of Split Scrambling. In particular, ancient classical languages allowed discontinuous DPs and PPs, and so did Old Church Slavonic and Old Russian from which contemporary Russian inherited discontinuity. A brief historic overview is presented in the next section.

### 5.3.1. Historical Overview

Research in comparative Indo-European linguistics as presented by Hall (1995) shows that quite a few ancient Indo-European languages had a poetic device known as *hyperbaton*. This Greek term comes from a combination of two stems: *hyper* + the aorist participle of *baino* 'to come'; and means 'stepped over', 'passed over'. In Alexandrian philology the term *hyperbaton* was used to describe a movement of one constituent over another, which was regarded as bad style.

Hall notes examples of *hyperbaton* in three ancient languages which represent three of the major branches of the Indo-European family: Latin (10a), Ancient Greek (10), and Sanskrit (10c):<sup>8</sup>

- (10) a. LATIN: ... tibi suavis<sub>1</sub> daedela tellus summittit t<sub>1</sub> flores.  
 thee sweet-ACC artful earth sends up flowers-ACC  
 '[for] thee the artful earth sends sweet flowers.'
- b. GREEK: Ménin<sub>1</sub>, áeide, t<sup>h</sup>ea, Peleíadeo Ak<sup>h</sup>ileos  
 wrath-ACC sing goddess-VOC of Peleidean-GEN Achilles-GEN  
ouloménen t<sub>1</sub>, ...  
 destroying-ACC  
 'Sing, o Goddess, Peleidean Achilles' destructive wrath ...'
- c. SANSKRIT: hiranyáyena<sub>1</sub> Savitá<sub>2</sub> t<sub>1</sub> ráthena, á<sub>3</sub> t<sub>2</sub> devó t<sub>3</sub> yati bhuvanani  
 [on] golden-INSTR Savitr-NOM car-INSTR to god-NOM goes beings  
 pásyān.  
 seeing  
 '... on [his] golden chariot, Savitr [the]god comes, seeing [all] beings.'  
 (Hall 1995: (9)-(11))

Summarizing these cases, Hall writes:

"Hyperbaton movement usually seems to occur right to left and to consist of the preposing of an element, but there are cases of rightward movement as well. Adjectives and nouns in the genitive seem most likely to be moved but nouns in other cases may be moved as well. Hyperbaton may occur only once within a constituent. ... The purpose of hyperbaton ... was rhetorical: it helped the poet foreground essential information and maintain poetic tension and surprise throughout the sentence."

Hall proposes that *hyperbaton* is a poetic device which was inherited by Latin, Ancient Greek, and Sanskrit from Indo-European. This hypothesis can be strengthened to the extent that there is evidence that *hyperbaton* existed in one or more of the other Indo-European languages as well.

There is some suggestive evidence that Old Church Slavonic allowed *hyperbaton*.

Perevlessky in his *The Slavic Grammar* (1879) showed the following examples:<sup>9</sup>

- (11) a. рѣвѣи пастыри хвоѣ blagovestvujutъ рождѣство.  
 righteous shepherds Christ's-ACC greet Nativity-ACC  
 'The righteous shepherds are greeting the Nativity of Christ.'
- b. ... xristosovi učenci blagovetstvovaša xristosovoje iz mŕtvyix poroždenije.  
 Christ's disciples greeted Christ's-ACC from dead-GEN resurrection-ACC  
 'The disciples of Christ greeted Christ's resurrection from the dead.'

<sup>8</sup> The traces in examples (10) are placed by Hall.

<sup>9</sup> The letters ѣ and љ in examples (11) are reduced vowels used in Old Church Slavonic and Old Russian.

Just two examples are not sufficient to support the claim that Old Church Slavonic had *hyperbaton* as a standard rhetorical device inherited from the Indo-European protolanguage, but these instances hold out some hope that more examples may be found to support this claim.

If it turns out to be true, we would expect to find *hyperbaton* in later stages of the development of Old Church Slavonic, i.e., in its descendants on the Russian branch. We know that Contemporary Russian in some of its forms (Literary Russian (12a) and Colloquial Russian (13b)) has *hyperbaton*:

- (12) a. A v more vysokaja xodit volna.  
 But in sea-LOC high-NOM rises wave-NOM  
 'But a high wave is rising in the sea.' (Čukovskij 'Doktor Ajbolit')
- b. Včerašnie ležat na stole gazety.  
 yesterday-NOM are on table-PREP newspapers-NOM  
 'Yesterday's newspapers are on the table.'

The intermediate stages that should be investigated are Russian Church Slavonic and Old Russian. An adjective separated from its head noun is an especially productive phenomenon in Colloquial Russian. It could be expected that Old Colloquial Russian might have this construction as well. There is an extraordinary source of Old Colloquial Russian in the form of the birchbark notes that have been being excavated in Novgorod, one of the oldest Russian cities between Moscow and St. Petersburg. Birchbark notes and letters are believed to reflect Old Colloquial Russian as spoken by merchants between the mid-12th C. and the beginning of the 15th C. Janin and Zaliznjak (1986) conducted an extensive study of the birchbark notes including their syntactic analysis. They describe a particular phenomenon of the birchbark notes' syntax – preposition doubling.<sup>10</sup> They identify two contexts in which this preposition doubling occurs. One of these contexts is specified as where "the noun phrase is split by words that do not belong to it":

---

<sup>10</sup> This phenomenon does suggest Copy/Spellout analysis rather than movement.

- (13) a. Letter #601 ... a za sa[ni] po 5 kouno za dov[oe] ...  
 and for sleds-ACC 5 kunas for each-ACC  
 'and for each sled [is needed] 5 kunas [money unit] .'
- b. Letter #10 ... въ волости tvoej toliko voda piti в Gorodiščjanьx.  
 in region-PREP your-PREP only water to drink in Gorodishchjan-PREP  
 '.. in your Gorodishchjan region [there is] only water to drink.'  
 (Janin and Zaliznjak 1986: p.152)

The authors mention 5 other birchbark notes that have this construction in them, which makes a total of seven cases. The excavations are still in progress, so a final word has not yet been said in the study of this interesting source material.

Lapteva (1976) cites her earlier work (Lapteva, 1970) on noun phrases containing a single adjectival modifier in Old Russian (*Raspoloženie odinočnogo kačestvennogo prilagatel'nogo v sostave atributivnogo slovosočetanija v russkix tekstax XI-XVII vv.* 'Placement of a Single Quantitative Adjective in the AP in Russian Texts of the 11th-17th C.'). Examples with adjectives separated from their head nouns, both in prenominal and in postnominal positions, can be found in Old Russian. The prenominal adjective separated from the noun was used with a contrastive function while the postnominal adjective separated from its noun was used in several functions. All these functions have been preserved in modern Colloquial Russian and to a lesser extent in literary Russian. These will be described in Chapter 6.

### 5.3.2 PP and NP Breakup in Latin (Ostafin, 1986)

In his dissertation (1986) on Latin word order Ostafin directly addresses the problem of discontinuous constituency in DPs and PPs. He refers to the general phenomenon of discontinuous constituents on a lower-level as *syntactic breakup*. The case of Latin is especially interesting because discontinuous DPs and PPs in Latin share many common syntactic properties with split scrambling constructions in Russian. Latin is similar to Russian and differs from the scrambling languages described in Chapter 2, in that it has pragmatically-oriented word order patterns. Ostafin follows the classical tradition in specifying the purpose of such lower-level

discontinuous constituency as emphasis; that is, constituents on either edge of the clause S are interpreted as emphatic.

### 5.3.2.1 PP Breakup

Anticipating the debate in recent years on the issue of configurationality of free word order languages, Ostafin convincingly argues that Latin is underlyingly configurational. Possible surface orderings can be accounted for by positing movement operations to specific landing sites. With respect to the Latin prepositional phrase, he shows that it is underlyingly P NP, and all surface orderings are derived by movement to 1) the left periphery of PP; 2) the left periphery of S, and 3) the right periphery of S.

Two general types of PPs are considered: PPs with unmodified objects and PPs with modified objects (where the former can be considered to be a subcase of the latter). PPs with modified objects have a preposition and a noun with an adjective phrase modifying this noun.<sup>11</sup> The underlying order of such PPs is shown to be P–AP–NP. There are six logically possible orderings of these three elements; however, if we include cases where words that are not a part of the PP can occur between the parts of the phrase, this number increases to 24 logical possibilities (where X in Ostafin's notation stands for "one or more words that are not a part of PP, but a part of the PP's clause"):

|     |               |      |                          |      |                    |      |                    |
|-----|---------------|------|--------------------------|------|--------------------|------|--------------------|
| (1) | P - N - A     | (7)  | *N - P - A <sup>12</sup> | (13) | *A - N - X - P     | (19) | *P - X - N - A     |
| (2) | P - A - N     | (8)  | *A - N - P               | (14) | *N - A - X - P     | (20) | *P - X - A - N     |
| (3) | A - P - N     | (9)  | *N - A - P               | (15) | *A - X - N - X - P | (21) | *P - X - N - X - A |
| (4) | P - N - X - A | (10) | *N - X - P - A           | (16) | *N - X - A - X - P | (22) | *P - X - A - X - N |
| (5) | P - A - X - N | (11) | *A - X - N - P           | (17) | *A - P - X - N     | (23) | *A - X - P - X - N |
| (6) | A - X - P - N | (12) | *N - X - A - P           | (18) | *N - P - X - A     | (24) | *N - X - P - X - A |

<sup>11</sup> Ostafin considers only APs that consist of a single constituent, the head A. He does not explicitly state whether more complex APs behave in the same manner as a single adjective.

<sup>12</sup> (7) is a poetic ordering. Ostafin proposes parametric variation between prose orderings and poetic orderings such that some restrictions operating in prose can be relaxed in case of poetry to render them relatively acceptable. Only prose orders will be discussed here.

Only the first 6 of these orderings are actually found in Latin prose; the other 18 orderings are not possible. Ordering (2) is the underlying ordering, and (1) involves only reordering within NP. (3) - (6) exhibit a discontinuous NP, and can be derived by the three movement rules in (14). The application of these rules is constrained by a general requirement of the Proper Binding Condition: a moved constituent must c-command its trace.

- (14) a. Move AP to the left periphery of PP for (3)  
 b. Move AP to the left periphery of S for (6)  
 c. Move AP to the right periphery of S for (4)  
 d. Move N to the right periphery of S for (5)

Note that in (14b-d) the landing site is clause-peripheral; this looks very similar to the Periphery Constraint which is important for discussion of Russian split DPs and PPs. However, Ostafin makes it clear that the remnant PP out of which an element has scrambled need not be peripheral but must remain *in situ*. The orderings (8)-(24) (except for (10)) are violations of the *Right Adjacency requirement* proposed by Ostafin: either the adjective or the noun of the NP object of the preposition P must be right-adjacent to the P. Orderings (8), (9), (11)-(16) all share the property of preposition stranding by extraction. Orderings (17) - (24) share the property that some element that is not part of the PP is immediately to the right of the P. The Right Adjacency requirement does not need to be stipulated: Ostafin claims that it falls out of the universal requirement that clitics must cliticize to an element in their domain. Latin Ps are lexically specified as proclitics in the domain of PP, and they must attach forward to an adjacent word on their right (the P and the adjacent word form a single phonological word for the purposes of primary stress assignment). It appears that the right adjacent word that the preposition can cliticize to has to be a part of its object.

Finally, the contrast between a possible ordering (5) and two ill-formed ones, (7) and (10), is explained by a proposed *Head Movement Constraint* on leftward nominal movement:<sup>13</sup>

---

<sup>13</sup> Ostafin admits that "The proposed constraint on leftward nominal movement is in a sense theoretically superfluous. The absence of orderings which would result from violation of such a constraint can be explained directly by the absence of rules generating these orderings. The reasons for proposing this constraint are (1) to explain the nature of the apparent movement asymmetry in the prose ordering data and

“The “head” of a nominal constituent cannot move leftward out of that constituent.”  
(Ostafin 1986: 120)

However, the nominal head can move rightward as the well-formed (5) shows.

### 5.3.2.2 NP Breakup

In Latin, an adjectival modifier or the head N of an NP can move out of an NP, and this movement is always to the left or right periphery of a clause. There are three legitimate orderings of the parts of a discontinuous NP (15a-c):

- |      |    |               |    |                                                                              |
|------|----|---------------|----|------------------------------------------------------------------------------|
| (15) | a. | A - X - N - X | d. | *N - X - A - X                                                               |
|      | b. | X - A - X - N | e. | *A <sub>1</sub> - X - [ t <sub>1</sub> t <sub>2</sub> ] - X - N <sub>2</sub> |
|      | c. | X - N - X - A | f. | *N <sub>1</sub> - X - [ t <sub>2</sub> t <sub>1</sub> ] - X - A <sub>2</sub> |

The three acceptable orderings in (15a-c) can be explained by the same movement rules proposed for the PP breakup in (14). The ordering (15d) is ruled out by the Head Movement Constraint on leftward nominal movement (just as is the case with the PP breakup). The ill-formed ordering (15e) is ruled out as a violation of Subjacency. Ostafin claims that Latin movement is constrained by Subjacency, where the bounding nodes for Latin are NP, S, and S'. He notes that if there is movement of AP and N to the left and right periphery of S respectively, one of them will necessarily cross two bounding nodes: the NP node it was contained in and the S node created by the adjunction of the other constituent. The ill-formedness of construction in (15f) stems from violations of two constraints at the same time: Subjacency and the Head Movement Constraint.

As was shown in Section 5.2, Russian Split Scrambling allows only one split constituent per clause. Ostafin does not discuss multiple Split Scrambling cases for PPs but he does show that in Latin poetry double splitting of NPs is possible, as shown in (16):

- (16) a. aurea            purpuream    subnectit fibula            vestem.  
 golden-NOM    purple-ACC    clasps    buckle-NOM    cloak-ACC  
 'A golden buckle clasps a purple cloak.'

---

(2) to ascertain what verse violates by allowing a more symmetric ordering distribution than that found in prose." (Ostafin 1986: 120)



5.3.3), Serbo-Croatian (Section 5.3.4), and Modern Greek (Section 5.3.5). These analyses provide important evidence concerning the parametric variation that UG permits in Split Scrambling.

### 5.3.3 VP-Remnant Topicalization (Den Besten and Webelhuth, 1990)

Den Besten and Webelhuth (1990) discuss the following four constructions in German which exhibit discontinuous constituency in various ways: 1) Remnant VP-Topicalization (17a), 2) Preposition Stranding (17b), 3) *was-für*- Split (17c), and 4) NP-Extraction (17d):

- (17) a. [<sub>VP</sub> t<sub>i</sub> gelesen] hat Hans [<sub>r</sub> das Buch<sub>i</sub> [<sub>r</sub> nicht t<sub>VP</sub>]].  
 read has Hans the book not  
 'Hans has not read the book.'
- b. weil Hans [<sub>r</sub> da<sub>i</sub> [<sub>r</sub> nicht]<sub>i</sub> [<sub>VP</sub> [t<sub>i</sub> mit] gerechnet] hat]].  
 because Hans there not with counted has  
 'because Hans had not expected that to happen.'
- c. Was<sub>i</sub> hat Hans [ t<sub>i</sub> für Leute] getroffen?  
 what has Hans for people met  
 'What kind of people did Hans meet?'
- d. Bücher<sub>i</sub> hat Hans [keine t<sub>i</sub>] gelesen.  
 books has Hans none read  
 'Hans has read no books.'

Despite the superficial look of a non-maximal projection in the sentence-initial topic position in these constructions, Den Besten and Webelhuth argue that the topicalized constituents in (17) really are maximal projections. In (17a), the scrambling operation removes parts of the VP into the middle field and then the VP-remnant (VP containing in general, one or more traces) is topicalized. Thus, VP-Remnant Topicalization is derived via a double movement analysis. In other examples, the scrambled phrases, *da* 'there' in (17b), *was* 'what' in (17c), and *Bücher* 'books' in (17d), represent maximal projections AdvP, NP, NP respectively. This extraction proceeds through the SPEC, DP position as is illustrated in (17' d) for the NP-Extraction cases:

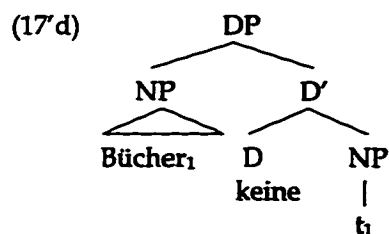

Den Besten and Webelhuth show that all the constructions in (17b-d) obey strict restrictions with respect to the surface order of the topicalized phrase (which they refer to as *the operator*) and the remnant from which it has been extracted. These restrictions follow from the generalization that an extracted operator has to c-command the remnant at S-Structure together with the requirement that traces have to be bound, either directly or through reconstruction. In (17b-d), the traces of the extracted operators are directly bound as argument traces (ignoring the intermediate traces). In (17a), however, despite the fact that the trace in this VP-Remnant Topicalization construction is not c-commanded by its antecedent, the sentence is grammatical. In this case, it is an argument trace bound by reconstruction, and den Besten and Webelhuth claim it is sufficient for an argument trace to be bound by reconstruction.<sup>14</sup>

This account of VP-Remnant Topicalization in German was the first Double-Movement analysis for a phenomenon which can be taken as related to Split Scrambling. Franks and Progovac (1994) then took up Den Besten and Webelhuth's idea and applied it to cases of discontinuous PPs in Serbo-Croatian. Their PP-Remnant Topicalization analysis for Serbo-Croatian data is discussed in the next section.

#### 5.3.4 PP-Remnant Topicalization (Franks and Progovac, 1994)

Franks and Progovac (1994) in their analysis of the placement of Serbo-Croatian pronominal clitics illustrate the nature of this phenomenon using constructions with split NPs (18a) and PPs (18b):

- (18) a. [NP<sub>A</sub> zanimljivu] sam knjigu] čitao.  
           interesting CL book I read  
           'I read an interesting book.'

---

<sup>14</sup> Den Besten and Webelhuth argue that there is a correlation between the availability of remnant Topicalization and the existence of scrambling in a language. German and Dutch are the only Germanic languages that allow remnant Topicalization, and they are the only scrambling Germanic languages.

- b. [<sub>PP</sub> u veliku] je Jovan ušao sobu.  
 into big CL Jovan walked room  
 'Jovan walked into the big room.'

Franks and Progovac note that these examples illustrate the general possibility in Serbo-Croatian of separating adjectives from the nouns they modify (18a),<sup>15</sup> and of separating a noun complement from both its modifying adjective and a governing preposition (18b).

They consider two possible analyses for the split PP sentences of type (18b): 1) the AP moves directly to SPEC, CP, in violation of the Left Branch Condition (LBC)<sup>16</sup>; 2) The noun scrambles out of the NP and PP, and the remnant subsequently moves to SPEC, CP. The authors note that the first solution might in fact be plausible if we recall that Wh-modifiers in SPEC, NP in Serbo-Croatian, as in many Slavic languages, can in general move out of the NP, as shown in (19):

- (19) Čija dolazi sestra?  
 Whose is coming sister  
 'Whose sister is coming?'

However, Franks and Progovac pursue the second alternative which they refer to as *PP-Remnant Topicalization*, an approach very similar to den Besten and Webelhuth's (1990) analysis of VP-Remnant Topicalization in German (see Section 5.3.3. above). The derivation of (18b) will proceed as follows:

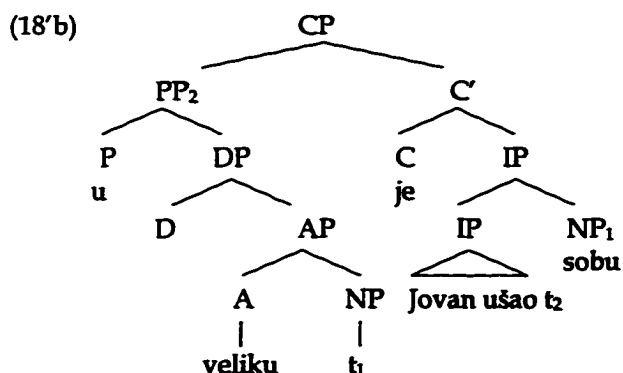

<sup>15</sup> It is interesting to observe that Franks and Progovac do not discuss how the split DP of (18a) is derived. In fact, they do not even account for split DP constructions in Serbo-Croatian although they use examples like (19), (23)-(24) below in their article. It is not clear whether it is possible to have N X Adj split order in this language and whether there are any restrictions on different word order combinations of N and Adj.

<sup>16</sup> Bailyn (1995) in his discussion of AP Scrambling in Russian also argues that the LBC should be relaxed for languages like Russian.

As the first step, the head noun *sobu* 'the room' moves out of the PP and right-adjoins to the IP. Then the remnant [*u veliku t<sub>1</sub>*] 'into big' topicalizes to SPEC, CP. Note that Franks and Progovac generate an NP as a complement to an A because, as they show, only NPs (20a) but not what they regard as APs (20b) can undergo the first step (moving out of the PP) in the process of PP-

*Remnant Topicalization*::

(20) a. [<sub>PP</sub> *u ovu t<sub>1</sub>*] *sam se zaljubio* [<sub>NP</sub> *studentkinju fizike*]<sub>1</sub>.  
 in this CL CL fell in love student of physics  
 'I fell in love with this student of physics.'

b.?? [<sub>PP</sub> *u ovu t<sub>1</sub>*] *sam se zaljubio* [<sub>AP</sub> *lepu studentkinju*]<sub>1</sub>.  
 in this CL CL fell in love pretty student  
 'I fell in love with this pretty student.'

It is possible to scramble the NP *studentkinju fizike* 'student of physics' out of the PP where the complement *fizike* 'of physics' scrambles along with the head noun *studentkinju* 'student' and then topicalize the remnant preposition plus adjectival demonstrative *v ovu t* 'in this t' in (20a). It is impossible to do the same manipulations with the word combination *lepu studentkinju* 'pretty student' in (20b), because the modifier *lepu* 'beautiful' cannot scramble along with the head noun.

The construction in (20b) is not the only example of illicit split word orders in Serbo-Croatian. An NP cannot itself be moved out of the PP and topicalized, as shown in (21):

(21) \*<sub>[NP</sub> *sobu*]<sub>1</sub> *Jovan ušao* [<sub>PP</sub> *u veliku t<sub>1</sub>*].  
 room Jovan walked into big  
 'Jovan walked into the big room.'

This is reminiscent of the Preposition-First phenomenon in Russian, but Franks and Progovac suggest that the ill-formedness of examples like (21) stems from a violation of the Scope Preservation Principle (22):

(22) *Scope Preservation Principle*:  
 "Surface word order respects relative scope as much as possible."  
 (Franks and Progovac 1994: (11))

It follows that except in special circumstances, the elements of a DP or PP cannot be reordered when they are separated from each other. Since in (21) the scrambled NP precedes an adjective that modifies it, the scope relations are disrupted in this sentence, and the Scope Preservation

Principle rules it out. In general, in Serbo-Croatian both Scrambling (no clitics, the moved phrase adjoins to IP), as in (23), and Topicalization, (clitic second, the moved phrase moves into SPEC, CP), as in (24), preserve scope relations. If there is more than one modifying adjective, the second one cannot be extracted over the first one, as the contrast between (23a)-(24a) and (23c)-(24c) shows (where *ovu* 'this' is an adjective):

- (23) a. \*[<sub>IP</sub> zanimljivu<sub>1</sub> [<sub>IP</sub> Jovan čita ovu t<sub>1</sub> knjigu]].  
           interesting Jovan is reading this book  
       b. \*[<sub>IP</sub> knjigu<sub>1</sub> [<sub>IP</sub> čita Jovan ovu zanimljivu t<sub>1</sub>]].  
       c. [<sub>IP</sub> ovu<sub>1</sub> [<sub>IP</sub> Jovan čita t<sub>1</sub> zanimljivu knjigu]].  
       'Jovan is reading this interesting book.'
- (24) a. \*[<sub>CP</sub> zanimljivu<sub>1</sub> je [<sub>IP</sub> ovu t<sub>1</sub> knjigu] pročitao].  
       b. \*[<sub>CP</sub> knjigu<sub>1</sub> je [<sub>IP</sub> ovu zanimljivu t<sub>1</sub> pročitao]].  
       c. [<sub>CP</sub> ovu<sub>1</sub> je [<sub>IP</sub> t<sub>1</sub> zanimljivu knjigu pročitao]].  
       'He read this interesting book.'

Franks and Progovac's analysis of PP-Remnant Topicalization in Serbo-Croatian appears to be a promising one for Russian because the Serbo-Croatian cases of Split PPs are exactly like the Russian split PP cases we are interested in (cf. (1a) above) except that Russian does not obey the Scope Preservation Principle. Also, Serbo-Croatian is related to Russian since both languages belong to the Slavic family. These constructions are found in modern Serbo-Croatian, a living language, in contrast to classical Latin and are therefore more accessible for study. However, there are some problems with this analysis as well as some details that are not discussed but which would be relevant for the analysis of Russian discontinuous constituents.

First, Franks and Progovac do not extend their analysis of split PPs to split DPs. It remains unclear what word order restrictions are imposed on discontinuous DPs and whether the Scope Preservation Principle accounts for all impossible combinations. However, it is crucial that an analysis of Split Scrambling in Russian could handle symmetrical split word orders for DPs (see (2) above) which appear to violate the Scope Preservation Principle.

Second, they assume a syntactic structure for the Serbo-Croatian DP in which the AP takes an NP as its complement (18'b). The only argument they use to support this hypothesis is

different possibilities of splitting DPs which contain more than one modifying adjective ((20a) vs. (20b)). Franks and Progovac claim that the reason for this is the AP status of the complex phrase in (20b). However, there is a possible independent reason for the ungrammaticality of Russian examples similar to Serbo-Croatian (20b): a violation of the restriction in Russian on splitting a DP that has more than one modifying adjective. The Scope Preservation Principle (22) and the AP dominating the NP structure of Franks and Progovac cannot account for these Russian facts.

Third, Franks and Progovac base their analysis on the assumption that Serbo-Croatian has a well-defined rule of Topicalization (substitution into SPEC, CP) which is revealed by the facts related to the clitic placement restrictions in this language. They also mention that Serbo-Croatian has Scrambling (adjunction to IP), and the difference between the two processes is illustrated by examples (23) and (24). However, in Chapter 2 of this dissertation it has been suggested that possibly there is no separate Topicalization operation in Russian, but everything is XP-Scrambling. Thus, PP-Remnant Topicalization will not be justified for Russian data though PP-remnant Scrambling maybe; see Section 5.5 below.

The distinction between Topicalization and Scrambling also bears on the question of whether in Serbo-Croatian, the second step of the movement, i.e., the movement of the PP-remnant into SPEC, CP is obligatory. Franks and Progovac show that there are examples where this second step does not appear to be obligatory, as in (25), which they admit may appear problematic for their analysis:

- (25) ?[v vrlo] je veliku Jovan ušao sobu.  
           into very CL big Jovan walked room  
           ‘Jovan walked into a very big room.’ (Franks and Progovac, 1994: fn.6)

The preposition *v* ‘into’ cliticizes onto the adverb *vrlo* ‘very’ which heads the AdvP in SPEC, AP and then the adverb moves into SPEC, CP to support the clitic *je*. If it is not clear how obligatoriness of the second step of the movement can be enforced in the case of Topicalization with the clitic second phenomenon, it is going to be even more difficult to enforce it for Scrambling in Russian.

Finally, Franks and Progovac propose to account for the ungrammaticality of one particular split PP word order in Serbo-Croatian, \*NP<sub>1</sub> ... [PP P Adj t<sub>1</sub>], as a violation of the Scope Preservation Principle which allows leftward movement of the first part of the constituent but disallows leftward movement of any other parts that are not constituent-initial. Note that both examples in (23)-(24) have two modifying adjectives one of which is the demonstrative *ovu* 'this'. Avrutin (1992), however, showed for Russian that the demonstrative *ëtot/ëta/ëto* 'this-M/F/N' has the property of making any extraction out of the DP impossible, as shown in (26):

- (26) a. Ivan s'el èto vkusnoe jabloko.  
 Ivan-NOM ate this-ACC tasty-ACC apple-ACC  
 'Ivan ate this tasty apple.'
- b. \*Kakoe<sub>1</sub> Ivan s'el èto t<sub>1</sub> jabloko?  
 which kind-ACC Ivan-NOM ate this-ACC apple-ACC  
 'What kind was that apple that Ivan ate?' (Avrutin 1992: (18))
- c. Kakoe<sub>1</sub> Ivan s'el t<sub>1</sub> jabloko?  
 which kind-ACC Ivan-NOM ate apple-ACC

If Serbo-Croatian demonstrative *ovu* 'this' has the property of blocking extraction on a par with the Russian *ëtot* 'this', then the Serbo-Croatian examples in (23)-(24) are not relevant in showing the Scope Preservation Principle at work. Also, if the Scope Preservation Principle is at work in all split constructions we would expect it to rule out the split word order N X Adj for the split DP in the manner it rules out the Serbo-Croatian example (21) above. However, the N X Adj split order is grammatical in Russian. Thus, as was noted above, the Scope Preservation Principle is not true of Russian. It may nevertheless be true of Serb-Croatian, but it would be more satisfactory if one account worked for both languages. Ideally, the Double-Movement analysis for Split Scrambling in Russian presented in Section 5.5 should be able to account for Serbo-Croatian, either as is, or with different parameter values.

### 5.3.5 Split DP Focus Constructions in Modern Greek (Androutsopoulou, 1997)

In Modern Greek, as shown by Androutsopoulou (1997), both DPs, as in (27a) and PPs, as in (27b), can be split (in Androutsopoulou's notation, the focused constituent is capitalized):

(27) a. to KOKKINO idha forema  
 the RED saw-1s dress  
 'It is the RED dress that I saw.'

b. me BLE eghrapsa molivi  
 with BLUE wrote-1s pencil  
 'I wrote with a BLUE pencil.'

(Androutsopoulou 1997: (14), (39))

The constituent on the left, separated from its noun, can be of various syntactic nature: possessor, demonstrative, numeral, quantifier, attribute adjective, and longer DP-internal string. These split DPs obey the generalizations in (28):

(28) a. The displaced DP-internal string, A, must form together with the DP-string that remains behind, B, a grammatical DP in that very order, AB;

b. A DP-internal string can be displaced if it can appear in isolation as a DP-fragment.

(Androutsopoulou 1997: (8))

The displaced constituent which ends up at the left periphery of the clause is a DP which is shown by the fact that it has the distribution of a DP: when not preposed, it can appear in subject, object, and complement of a preposition positions in a clause.

Androutsopoulou refers to examples like (27) as *Adjective Displacement (AD)* and argues that since the adjective *to KOKKINO* 'the red' in (27a) is contrastively focused, AD is an instance of Focus movement which is of A'-type. The arguments for a movement analysis of AD include long-distance cases, sensitivity to strong islands, subject/object asymmetries, reconstruction effects, and PG licensing. AD is analyzed as a Double-Movement operation which consists of two steps: XP-Scrambling and Focus movement. The derivation for (27a) is represented in (27'):

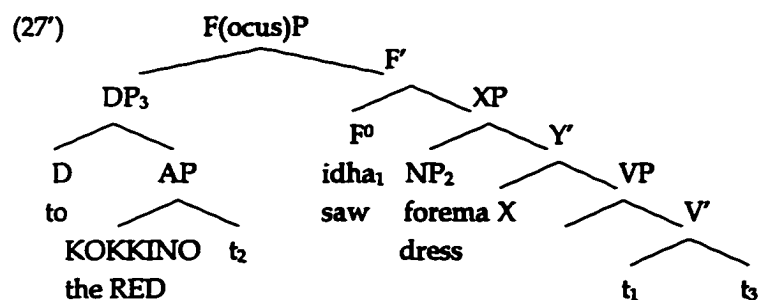

First, the verb raises to F<sup>0</sup>. Then the NP *forema* 'dress' undergoes XP-Scrambling into SPEC, XP (the nature of this XP is left unspecified). Finally, the DP-remnant with the trace inside undergoes Focus movement into SPEC, FP in order to receive Contrastive Focus.

What forces all these instances of movement? Nothing is said about the verb raising. Motivation for the NP-extraction is specified, though the existence of the NP-extraction is supported by the fact that in small clause constructions with discontinuous DPs, the NP cannot surface in its base position (29a) but has to be higher in the tree, as in (29b):

- (29) a. tin KALITERI theoro tin Maria ipopsifia.  
           the BEST consider-1s the Mary candidate
- b. tin KALITERU theoro ipopsifia tin Maria.  
           the BEST consider-1s candidate the Mary  
           'I consider Mary the BEST candidate.' (Androutsopoulou 1997: (35))

Additional argumentation of the same type is provided using double-object constructions (split of an indirect object DP is preferred when it precedes the direct object) and placement of VP-adverbs.

Motivation for the DP-remnant to move to SPEC, FP comes from the necessity to assign a Contrastive Focus to the adjective. Note that if Androutsopoulou is right that Focus movement is obligatory ingredient of the split construction, it must be the case that examples as in (30) are ungrammatical, i.e., that Modern Greek (just like Serbo-Croatian) is asymmetrical with respect to possible split word orders (cf. (27)). However, Androutsopoulou does not discuss this matter:

- (30) a. idha forema<sub>1</sub> [<sub>DP</sub> to kokkino t<sub>1</sub>].  
           bought dress the red
- b. forema<sub>1</sub> idha [<sub>DP</sub> to kokkino t<sub>1</sub>].  
           dress bought the red

Androutsopoulou's analysis of split DPs in Modern Greek is important to the Double-Movement analysis of Split Scrambling in Russian, proposed in Section 5.5 in several ways: it consists of at least two steps; it requires a special Focus projection to be generated above IP; it is Focus-driven. However, there are major differences between the Greek and Russian facts: the

remnant appears to have considerably more freedom of leftward movement in Greek than in Russian; and Greek Adjective Displacement constructions appear (see above) to be asymmetrical in allowing only (P) Adj X N split word order, like the Serbo-Croatian constructions discussed in 5.3.4. It may be that Russian is in the minority with respect to this aspect of split constructions. It is not obvious whether Modern Greek obeys the Periphery Constraint. Nothing is said about other possible restrictions that AD constructions may obey (e.g., is there the One-Split-per-Clause Constraint?) and whether there are other ill-formed split word orders that are disallowed in this language. Finally, since Androutsopoulou follows Kayne's (1994) antisymmetry theory, she does not allow rightward movement of any sort. In Section 5.5 I will argue for the Double -Movement analysis for Split Scrambling in Russian which crucially requires rightward adjunction. In view of the data in (29) this may be a real difference between the two languages, not just a difference of analysis. If so, some additional parameterization is called for, but I will not pursue it here.

I now briefly survey attempts existing in the literature which account for Russian discontinuous DPs.

#### 5.4 Syntactic Accounts of Split Scrambling in Russian

This section provides a survey of the recent attempts to account for split DP and PP constructions in Russian. None of them has been really carried through into a complete analysis of such structures. Some are just a collection of descriptive facts about possible word orders in sentences which contain split DPs and PPs, others offer partial explanations. Nevertheless, it is helpful to discuss them because some aspects of these analyses can be successfully incorporated into a fuller account to be presented in Section 5.5.

#### 5.4.1 The DP-Hypothesis and the Barriers Framework (Yearley, 1993)

Yearley compares Russian discontinuous DPs to similar constructions in Mohawk and Warlpiri. She shows that the analysis proposed for Mohawk and Warlpiri discontinuous DPs, according to which overt objects are base-generated in an IP-adjoined position and are coindexed with some sort of null pronominal in an argument internal position<sup>17</sup>, cannot be maintained for Russian.

Yearley assumes that Russian is completely non-directional in the sense that heads may project their specifiers and take their complements on either side. Case and Theta-assignment are non-directional, too. With these assumptions in mind, she considers advantages and disadvantages of a movement analysis for Russian discontinuous constituents. There are three major questions that need to be addressed under the movement approach. The first is whether discontinuous constituents are derived by head or phrasal movement. Yearley considers the head movement analysis for such constructions and rejects it because even for simple cases like (31a) the Head Movement Constraint would be violated. It has to be some sort of phrasal movement that is responsible for discontinuous constituency in Russian. This is the position I will take for purposes of the Double-Movement analysis presented in Section 5.5:

- (31) a. [<sub>C</sub> Knižku<sub>1</sub>] ja včera pročital interesnuju t<sub>1</sub>.  
 book-ACC I yesterday read interesting-ACC  
 'I read the interesting book yesterday.'
- b. Na bol'suju kuricu t<sub>1</sub> položi [<sub>C</sub> tarelku<sub>1</sub>].  
 on big-ACC chicken-ACC put plate-ACC  
 'Put the chicken on the big plate.'

The two problems that the phrasal XP-movement analysis has to deal with are: 1) it is not always clear which part of the DP subconstituent has moved; and 2) extraction of DP subparts is possible from both subjects and adjuncts although these are presumably islands. Yearley's

---

<sup>17</sup> For details of the pronominal argument account of discontinuous constituency in Mohawk see Baker (1991), in Warlpiri see Austin and Bresnan (1996).

proposal addresses both problems in the following way. She adopts Abney's (1987) DP-Hypothesis for Russian, shown in (32):

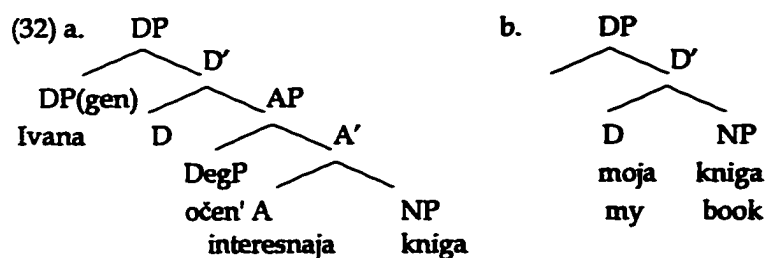

Ivan-GEN very interesting book  
'Ivan's very interesting book'

The discontinuity effects are due to a subcase of Scrambling where subparts of DPs can move out of their base-generated positions and adjoin to IP (just like regular XP-Scrambling of full DPs). However, this immediately faces a problem with ECP violations. None of the elements internal to DP are themselves  $\theta$ -governed, so the traces of the moved parts must be antecedent-governed. If  $A^0$  and  $D^0$  can be considered as proper governors for traces of their complements, we can account for many discontinuity effects by allowing the rightward moved element to travel up in a successive cyclical fashion through open specifier positions within its own extended projection. This analysis accounts for unproblematic cases, such as (31a): first, the entire direct object DP *interesnuju knižku* 'the interesting book-ACC' scrambles out of the VP and left-adjoints to IP, and then the adjective *interesnuju* 'interesting' travels up through this scrambled DP and scrambles out of it, adjoining to the right of IP, as shown in (31'a). Yearley refers to this analysis as *Multiple Scrambling*. This is similar to the Double-Movement analysis of Split Scrambling I argue for in Section 5.5, though there are constraints which Yearley's analysis does not fully capture.

(31a')

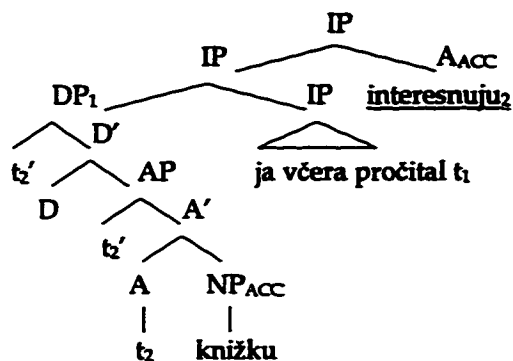

lit. The book-ACC I yesterday read interesting-ACC.  
 (= 'I read the interesting book yesterday.')

However, Yearley notes that problems remain concerning extraction out of adjuncts, subjects, and cases with degree word modifiers within DP, which would have to be derived in a similar way, i.e., through multiple Scrambling. This inevitably poses a problem for the *Barriers*-type approach. In such cases it will be necessary to postulate some illicit intermediate adjunctions.

Yearley's analysis clearly shows that Split Scrambling in Russian is a phrasal movement, not a head movement, and that it consists of two steps. Note the similarity (although details differ) among VP-Remnant Topicalization in German (den Besten and Webelhuth, 1990) (see Section 5.3.3 above), PP-Remnant Topicalization in Serbo-Croatian (Franks and Progovac, 1994) (see Section 5.3.4 above) and Yearley's tentative account of the split DPs and PPs: all three require double movement. In Yearley's analysis, however, the XP remnant moves first, i.e., before it becomes a mere remnant. I will argue in Section 5.5 for this version of the general idea of Split Scrambling as derived by double movement, though some crucial differences from Yearley's assumptions. In my proposal, the first step involves application of standard XP-Scrambling as described in Chapter 2, where the scrambled XP is scrambled into SPEC, FP; the second step of the process involves extraction of a Y' out of this XP and right-adjoining it to FP. This makes it possible to explain restrictions on split scrambling orders in Russian, and to answer the

explanatory question what motivates Split Scrambling in Russian. I believe it is possible to make some progress with respect to the problem of the ECP violations which Yearley raises.

#### 5.4.2. Scrambling of Pieces of Phrases (Franks, 1993)

Franks (1993) suggests that XP-Scrambling (scrambling of phrases) is different from “scrambling of pieces of phrases” in that there appear to be particular restrictions that Split Scrambling obeys, in contrast to XP-Scrambling. He describes Scrambling of pieces of phrases in Russian, i.e., discontinuous constituency, as movement of elements from maximal projections, as shown in (33):

- (33) a. Čemodan<sub>1</sub> ja ponesu [ t<sub>1</sub> tvoej \_\_\_\_\_ ženy].  
 suitcase-ACC I will carry your-GEN wife-GEN
- b. (??) Tvoej<sub>1</sub> ja ponesu [čemodan t<sub>1</sub> ženy].  
 your-GEN I will carry suitcase-ACC wife-GEN  
 ‘I will carry your wife’s suitcase.’
- c. (\*) Krasivoj stol byl [t<sub>1</sub> skater’ju t<sub>2</sub>] pokryt [iz l’na]<sub>2</sub>  
 beautiful-INSTR table was tablecloth-INSTR covered from flax  
 ‘The table was covered with a beautiful linen tablecloth.’ (Franks 1993: (5)-(6))

Franks’ examples in (33) are meant to be parallel to examples of discontinuous DPs, which I illustrated above in (1) and (31). However, I must note that I do not share the judgments of Franks’ informants who regarded examples (33b, c) as grammatical. For me as a native speaker, (33b) is very marginal while (33c) is ill-formed. These judgments are shown in parentheses in (33b, c). The disagreement in judgments with Franks’ informants makes it hard to evaluate Franks’ proposal about the nature of Split Scrambling because it is based on the contrast between (34a) and (34b). As with examples in (33b, c), I disagree with Franks’ informants and find (34a) ungrammatical (indicated by \* in parentheses):

- (34) a. (\*) o.k. Oni interesnuju<sub>1</sub> dočke<sub>2</sub> predložili moej t<sub>2</sub> t<sub>1</sub> rabotu.  
 they interesting-ACC daughter-DAT offered my-DAT work-ACC
- b. (\*) ?\* Oni dočke<sub>2</sub> interesnuju<sub>1</sub> predložili moej t<sub>2</sub> t<sub>1</sub> rabotu.  
 they daughter-DAT interesting-ACC offered my-DAT work-ACC  
 ‘They offered my daughter interesting work.’ (Franks 1993: (19)-(20))

Franks claims that the difference in acceptability between (34a) and (34b) as reported by his informants (i.e., that (34a) is acceptable but (34b) is not) stems from the fact that the dependencies between the fillers and gaps in (34a) are nested, while in (34b) they are crossed. The parser is claimed to employ a pushdown storage mechanism which ensures a “last-in/first-out” pattern, and the second member of a crossed dependency cannot be accessed until the element added on top of the stack has been removed. This is a well-known phenomenon discussed in the literature under the headings of the *Nested Dependency Constraint* and the *Crossing Constraint* (Fodor, 1978; Pesetsky, 1982). In (34a), *dočke* ‘daughter-DAT’ is on top of the stack and is accessible when the DAT possessive modifier *moej* ‘my-DAT’ is encountered, which makes it possible to concatenate them. In (34b), however, *interesnuju* ‘interesting-ACC’ is on top of *dočke* ‘daughter-DAT’ and cannot be removed from the stack to concatenate with its second part *moej* ‘my-DAT’. Franks uses these examples to support his idea for a pushdown parsing mechanism according to which sentences like (34b) are ruled out not on grammatical grounds but for processing reasons.

It is an interesting observation that some scrambling constructions may be not ungrammatical but unacceptable since the Nested Dependency Constraint is known to influence processing. However, as noted above, I do not share the intuitions of Franks’ informants about the acceptable status of (34a) where the dependencies are nested: *interesnuju<sub>2</sub> dočke<sub>1</sub> ... moej t<sub>1</sub> t<sub>2</sub> rabotu* ‘interesting -ACC daughter-DAT... my-DAT work-ACC’. Informal inquiries I carried out in Moscow with about 20 native speakers showed that they do not accept sentences with double splits at all, no matter whether the dependencies are nested or crossed. Therefore, we need to look for a general explanation for the One-Split-per-Clause Constraint on Split Scrambling in Russian. In Section 5.5 and Chapter 6 I present an attempt to derive this constraint from the Double-Movement analysis and restrictions on Focus structure. In Chapter 7 I consider the possibility that it has its origin in processing limitations.

### 5.4.3 The DP-Hypothesis, the Left Branch Constraint and Subjacency (Bailyn, 1995)

Bailyn argues that word order within the DP is much more fixed than that within the clause. Adjectives canonically precede the noun they modify unless there are contextually marked circumstances which require an adjective to move to a position outside of the NP. Thus adjective<sup>18</sup> before noun is the underlying word order within NP. The order Noun - Adjective is possible when the adjective which follows the noun it modifies is used as focus, as shown in (35):

- (35) Maša                    devočka UMnaja.  
Masha-NOM girl-NOM [smart-NOM]-F  
'Masha is a smart girl.'

Attributive adjectives may be scrambled out of their NPs, in contrast to scrambling languages like German, Dutch, Japanese, and Korean, discussed in Chapter 2. Even extraction of an AP containing a complement is possible, as shown in (36):

- (36) Zelenuju                    ot solnca Ivan ljubit t<sub>1</sub> travu.  
green-FEM/ACC/SG from sun Ivan likes grass-FEM/ACC/SG  
'Ivan likes green from the sun grass.' (Bailyn 1995: 229-231)

Russian also fronts not only attributive adjectives, but also possessive DP specifiers, both in Scrambling and Wh-movement contexts. This is an apparent violation of the Left Branch Condition (LBC), which is a stipulative constraint necessary to prevent extractions such as that in (36) from occurring in English. Examples like (36) demonstrate that the LBC, as a putative universal, is too strong for Russian.

Specifiers and left-branch modifiers can be left-extracted, but right-branch modifiers and NP complements cannot, as the ill-formedness of (37) shows:<sup>19</sup>

- (37) \*S dlinnymi volosami Boris znaet studenta.  
[with long hair]<sub>1</sub> Boris knows [student-ACC t<sub>1</sub>]  
'Boris knows a student with long hair.'

<sup>18</sup> Bailyn adopts Rubin's (1994) analysis of AP modifiers (as well as all other adjoined modifiers) as instances of a functional category Mod(ification) Phrase headed by the head Mod<sup>0</sup> which takes an AP complement.

<sup>19</sup> In the discussion of the split DP and PP constructions that follows in Section 5.5, I will not be concerned with right-branch modifiers and complements and will concentrate on the analysis of left-branch modifiers (specifically, a single modifying adjective.)

This similar to the Scope Preservation Principle effects noted by Franks and Progovac (1994), Bailyn argues that under the DP hypotheses, specifiers and left-branch modifiers are above NP in DP, and therefore their extraction does not violate Subjacency if it is NP and not DP that is a bounding node. By contrast, right branch modifiers and complements do cross an NP node (as well as IP).

Bailyn does not propose a formal syntactic analysis of Split Scrambling in Russian. He does not specify whether and how it is similar to standard XP-Scrambling, to what landing site movement occurs, where the remnant may appear, and what the precise mechanism of Split Scrambling is. He only suggests that it should be possible to account for it if the Left Branch Constraint is modified and combined with parameterization of Subjacency, an account similar in spirit to Ostafin's analysis of discontinuous DPs and PPs in Latin. (However, the facts of Russian differ from those of Latin in relevant ways, as will emerge in Section 5.5.) With respect to the issue of motivation of Split Scrambling, he makes two remarks: first, contextually marked circumstances may require the adjective to move out of its NP; and second, the post-nominal adjective is focused. In Chapter 6 I will argue that Split Scrambling in Russian is driven by Focus considerations, along the lines of Reinhart (1995)'s theory (see Chapter 3, Section 3.2).

#### 5.4.4 Copy and Deletion (Zybatow and Junghanns, 1995)

Recall that Zybatow and Junghanns (1995) in their theory of Russian Information-Structure (as discussed in Chapter 3, Section 3.3.5) distinguish two types of focus in Russian: informative focus and contrastive focus. The informative focus is tied to a particular position in the Russian clause (i.e., the right periphery of the clause), while the contrastive focus can occur in any position (it adjoins to any XP) provided it carries the right phonological stress, as shown in (38a-c). Consider the similarity of Split Scrambling constructions in (38) to Wh-movement constructions which can carry a contrastive focus, as shown in (39):

- (38) a. On zadal SLOŽnyj vopros.  
 he asked [DIFFicult]-CF question  
 b. On SLOŽnyj zadal vopros.  
 c. SLOŽnyj on zadal vopros.  
 'He asked a DIFFicult question.'

- (39) a. On zadal kaKOJ vopros?  
 he asked which-CF question  
 b. On kaKOJ zadal vopros?  
 c. kaKOJ on zadal vopros?  
 'Which kind of question did he ask?'

Zybatow and Junghanns propose to account for these contrastive focus constructions in (38) by using the Copy and Deletion theory of Movement (Chomsky, 1993). Under this analysis, the sentences (38b) and (39b) will have the following derivations, respectively:

- (36') b. On [DP složnyj vopros] zadal [DP složnyj vopros] COPY  
 On [[složnyj] [DP t vopros]] zadal [[složnyj] [DP t vopros]] OPERATOR RESTRICTION  
 On [[složnyj] [~~DP t vopros~~]] zadal [[~~složnyj~~] [DP t vopros]] DELETION  
 LF: on [složnyj x, x vopros] zadal  
 PF: On SLOŽnyj zadal vopros  
 lit. 'He a DIFFicult asked question.'  
 'It was a difficult question that he asked.'

- (37') b. [kako]j vopros] on zadal [kako]j vopros]? COPY  
 [[kako]j [t vopros]] on zadal [[kako]j [t vopros]]? OPERATOR RESTRICTION  
 [[kako]j [~~t vopros~~]] on zadal [[~~kako]j] [t vopros]] DELETION  
 PF: kaKOJ on zadal vopros?  
 lit. 'WHICH kind of he asked question?'  
 'Which kind of question did he ask?'~~

Note that Junghanns and Zybatow do not discuss the essential components of their analysis: how the contrastive focus is actually assigned, that is, by what mechanism, and how to account for acceptable split word orders and how to rule out the impossible ones. These shortcomings are due to the preliminary nature of their analysis which is presented as a working hypothesis and has not yet been fully developed. The extent to which copying and deletion rather than traditional movement is essential to the empirical consequences of their analysis is not fully clear at present. Clearly they differ in a number of respects, though they have some points in common. At present it is not easy to distinguish between differences among the languages being described, and differences in theoretical treatments of what are essentially the same facts.

The former differences need to be captured by parameterization of bounding or other aspects of movement in particular grammars. The latter constitute theoretical issues which need to be resolved. I have done my best in the following pages to find a consistent route through these difficult matters, and establish their implications for Russian.

#### 5.4.5 Summary

In Sections 5.4 and 5.3, different theoretical approaches which deal with discontinuous DPs and PPs have been discussed. Table 13 summarizes the essential points of these approaches.

**Table 13. Comparison of Theoretical Approaches to Split Scrambling Cross-Linguistically**

|                          | Latin<br>(5.3.2)           | German<br>(5.3.3)     | Serbo-<br>Croat.<br>(5.3.4) | Modern<br>Greek<br>(5.3.5) | Russian<br>(Yearley<br>(5.4.1) | Russian<br>(Franks)<br>(5.4.2) | Russian<br>(Bailyn)<br>(5.4.3) | Russian<br>(J & Z)<br>(5.4.4) |
|--------------------------|----------------------------|-----------------------|-----------------------------|----------------------------|--------------------------------|--------------------------------|--------------------------------|-------------------------------|
| Split phrases            | DP<br>PP                   | VP                    | PP                          | DP<br>PP                   | DP                             | DP                             | DP                             | DP                            |
| Mechanism                | Extraction;<br>Head Move-t | Double Movement       | Double Movement             | Double Movement            | Double Movement                | not available                  | Extraction                     | Copy/Deletion                 |
| First step               | A' or N'                   | All phrases out of VP | NP complement               | NP complement              | Scrambling of DP               | not available                  | not available                  | DP is copied                  |
| Second step              | not applicable             | VP-remnant            | PP-remnant                  | DP-remnant                 | A or N extraction              | not available                  | not available                  | subparti is deleted           |
| Landing site for remnant | <i>in situ</i>             | SPEC, CP              | SPEC, CP                    | SPEC, FP                   | IP-Adjunction                  | not available                  | not available                  | not available                 |

### 5.5. The Double-Movement Analysis of Split Scrambling in Russian

In order to account for split word orders, we first have to establish the underlying structure of the Russian DP and then to show how they are derived from it. I will draw on prior accounts (see Table 13 above) where appropriate and try to combine their merits in a single account that can cover all the known Russian facts.

It is generally assumed in Russian grammar that the D-Structure, unmarked, word order in the Russian DP is Adj – Noun where the adjective is continuous with the noun. Bailyn (1995) (see Section 5.4.3 above) argues convincingly that all the other orders including N – Adj must be derived from it as required by contextually marked circumstances. Thus, the order N – Adj is used to focus the adjective (see (35) above). Standard constituency tests (coordination, ellipsis, etc.) show that the N-plus-Adj phrase is a constituent.

There are two competing hypotheses with respect to the underlying structure of a DP cross-linguistically, the traditional one (40a) and the one proposed by Abney (1987), shown in (40b):

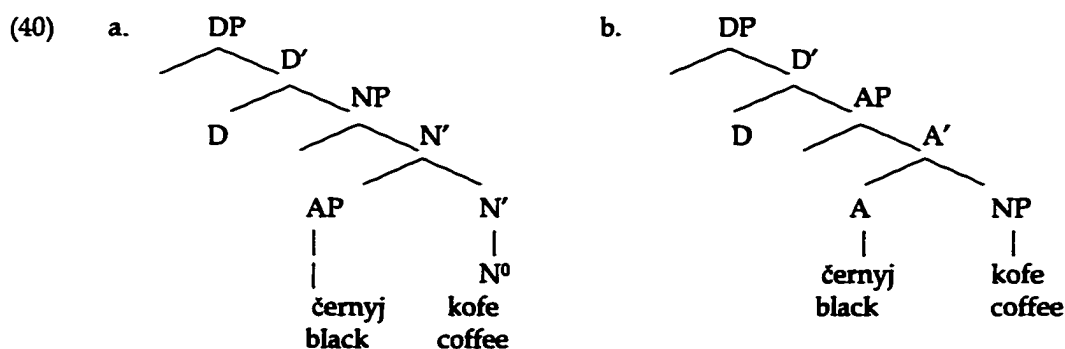

The Abney-type structure (40b) was assumed by Franks and Progovac (1994) and by Androutsopoulou (1997) (see Sections 5.3.4 – 5.3.5 above) in their respective accounts of PP-Remnant Topicalization in Serbo-Croatian and Adjective Displacement in Modern Greek. Franks and Progovac justify the necessity of generating an NP as a complement to an A by the fact that in Serbo-Croatian, only NPs but not APs can be extracted out of a PP (see examples in (20) above).



extended to cover the facts for other languages with Split Scrambling to comprise a parameterized theory of Scrambling.

How can the surface word orders (41b, c) be derived? There are a few plausible hypotheses with respect to the mechanism of Split Scrambling. Following Ostafin's (1986) analysis for discontinuous DPs and PPs in Latin, and Bailyn's (1995) idea to parameterize Subjacency in order to modify the Left Branch Constraint, one hypothesis is that Split Scrambling is simply a subcase of standard XP-Scrambling. Alternatively, it may involve double movement as proposed by Yearley (1993), Franks and Progovac (1994), and Androutsopoulou (1997). I will consider these possibilities in turn. I will conclude that the Single Movement account is unable to capture the full range of data, and the Double-Movement is necessary.

In the Single Movement analysis, the AP *černyj* 'black-ACC' is scrambled into the left IP-adjoined position resulting in the structure (43):

(43) S-Structure of (41b) under the Single Movement hypothesis:

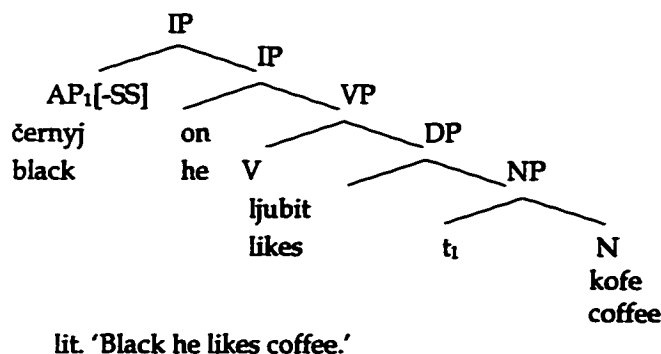

This works well enough for (41b), and a comparable account in which the noun *kofe* 'coffee-ACC' is scrambled leftward would suffice for (41c). However, in a sentence like *Černyj on ljubit pit' po večeram kofe* 'He likes to have black coffee in the evenings', the direct object *černyj kofe* 'black coffee-ACC' is base-generated as a sister to the V, which is not the clause-final position in this sentence because an adverbial follows. Clearly the noun *kofe* 'coffee-ACC' does not remain in that position. Thus, some sort of postposing (extraposition) is unavoidable. In fact, final position of the noun in the split scrambling is not only possible but obligatory, under the Periphery

Constraint. It appears, then, that Split Scrambling must be Double Movement in Russian. For uniformity of analysis, I assume that this is so even in the simple examples (41b) and (41c). Standard tests for constituency such as prosodic phrasing support this view. Thus all Split Scrambling in Russian is apparently due to Double Movement.

In the particular version of the Double Movement analysis that I will argue for, a DP (or PP) first moves out of its D-Structure position into the SPEC position of a higher functional projection F(ocus)P (see Section 6.4.2 below for discussion) via XP-Scrambling. Then an element Y is extracted out of it and is right-adjoined to FP. This element must be, or include, either an adjective or a noun. There are also three bar-level possibilities for the element Y:  $N^0$ ,  $N'$ , or NP (or  $A^0$ ,  $A'$ , and AP). Yearley (1993) (see Section 5.4.1) showed that from the point of view of restrictions on head movement, Russian Split Scrambling cannot involve movement of a head. In any case, the Y element of Split Scrambling can consist of an N modified by another (postnominal) noun in GEN, e.g., *fotografii detej* 'pictures-ACC of the children-GEN', as shown in (44):

- (44) Ljubimye on prines fotografii detej.  
 favorite-ACC he-NOM brought pictures-ACC children-GEN  
 'He brought his favorite pictures of the children.'

Hence, the only two possibilities left are  $N'$  and NP. In the traditional account of DP-internal structure adopted in this dissertation (40a), in contrast to Franks and Progovac (1994) and Androutsopoulou (1997) (40b), APs are  $N'$ -adjoined. Therefore, this extraposed element cannot be a whole NP. According to the structure in (40a) above, the element that is extraposed as the second step of deriving Russian split scrambling constructions such as (41b) and (44) via double movement has to be an  $N'$ . For uniformity I will assume that in examples with a final adjective such as (41c), what is extracted is  $A'$  (though in this case it is more difficult to rule out the possibility of AP movement).

This double-movement analysis encounters two obvious problems. First, as Den Besten and Webelhuth (1990) (Section 5.3.2.3) argued, movement of non-maximal projections is

prohibited by the universal theory of movement as defined by Chomsky in *Barriers* (1986). According to this otherwise well-motivated theory, only maximal projections and heads are allowed to move. It would be more satisfactory, both empirically and conceptually, to adhere to this strong universal theory than to introduce language-specific exceptions. Second, we need to address the question of how the trace of the extracted element is bound and how this element crosses the barriers on its way. Since FP is assumed to be above IP (for reasons outlined below), these barriers would comprise DP, sometimes PP, and IP (by inheritance) to reach the adjunction site at the right of FP. While there may be answers to these questions, they seem to require special assumptions not otherwise needed in syntactic theory. I will discuss the first question briefly here, and will return to the second question below.

Let us gather together the empirical evidence for movement of Y'. First, in the DP structure assumed in this dissertation, adjective is *inside* NP (see (40a) above), in contrast to the structure adopted by Yearley (1993), Franks and Progovac (1994), and Androutsopoulou (1997) in which an adjective takes an NP complement. In the instances when the noun is extracted but the adjective stays in the remnant, this category of the extracted element cannot be a maximal projection YP, otherwise the adjective would have been pied-piped along with the noun. It has also been shown above that this category cannot be a head (cf. the example (44) above). Thus, it has to be of a category Y'. Second, asymmetries between the NP-internal arguments and adjuncts show that a head noun can be extracted with its Genitive NP complement, while such extraction is not possible with N' adjuncts (cf. example (37) above). Finally, even if the Abney-type DP-structure is assumed, it would merely create a comparable problem for instances of adjective movement: it would still have to be an A', and not AP that is extracted. Nonetheless, I will set out the advantages of the Double-Movement analysis for split scrambling constructions in the belief that they may outweigh its current shortcomings.

The evidence for the Double-Movement analysis comes from the three specific restrictions this type of movement obeys in Russian (see (4) above). The Periphery Constraint

requires that the subparts of a split scrambling constituent be at the outermost edges of the clause. This implies that only an XP attached at the highest level of the clause can be split. The Y' extracted from it must also be at the highest level on the right (although this would also follow from the requirement that it c-command its trace in the XP). The limitation to one split constituent per clause indicates that this high site to which XP moves is not recursive. Thus it cannot be that XP adjoins to IP or CP.<sup>20</sup> Rather, there must be one designated base-generated position which is the XP's landing site, above the IP level. It can be deduced that the unique position that the remnant of a split scrambling construction resides in, is higher than the canonical subject position and beneath the complementizer position. The latter is shown by the contrast between (45a) and (45b):

- (45) a. \*On poprosil černogo, čtoby emu nalili kofe.  
 he asked black-GEN that-SUBJU him-DAT poured coffee-GEN
- b. On poprosil, čtoby černogo emu nalili kofe.  
 he asked that-SUBJU black-GEN him-DAT poured coffee-GEN  
 'He asked that they poured black coffee for him.'

Because of the strong association between Split Scrambling and Focus, as described in Chapter 6, I will hypothesize that this position is the SPEC of F(ocus)P, which selects IP as its complement (see Chapter 6 for discussion).

Split Scrambling serves the purpose of assigning Constituent Focus to one of the two subparts of the discontinuous constituent, the adjective or the noun. There is a difference in the landing site for XP-Scrambling in general and XP-Scrambling as the first step in Split Scrambling: while in the former case, a scrambled phrase is moved into the IP-adjoined (or VP-adjoined) position, either left or right, in the latter case, it is moved into SPEC, FP.<sup>21</sup> The SPEC position being on the left will require XP-Scrambling in Split Scrambling constructions to obligatorily

<sup>20</sup> XP does adjoin to IP in simple XP-Scrambling, which is iterative. The limitation is just that Y'-Extraction is only from the highest scrambled XP.

<sup>21</sup> Additional evidence that the first step in Split Scrambling is not adjunction to any major projection is that in split Scrambling the remnant phrase is never adjoined to VP, as it (arguably) is in some XP-Scrambling constructions (see Chapter 2 for discussion).

proceed to the left. XP-Scrambling, in contrast to Split Scrambling, does not have to involve Constituent Focus, but only serves to divide up the tree so that focus can be assigned to one part and not the other. Although it does not need SPEC, FP as a landing site, it can use it in sentences with multiple XP-Scrambling in which a scrambled phrase acquires special prominent status can move into SPEC, FP while others are IP- (or VP-)adjoined. This is parallel to multiple Wh-fronting constructions found in some Slavic languages like Serbo-Croatian in which preposed Wh-phrases do not form a constituent. Instead, only the first fronted Wh-phrase is located in Spec, CP; other Wh-phrases are adjoined to IP (Rudin, 1988).

The Preposition-First Constraint provides evidence for the direction of the two movement operations which comprise the Double-Movement analysis. Split PPs are particularly informative: Since only the orders P Adj X N and P N X Adj are allowed, the first movement, XP-Scrambling, has to proceed to the left. Then the fact that the second movement cannot extract a non-constituent from the scrambled PP guarantees that the preposition will remain on the left, with only A' or N' moving to the right. Note that the usual constraint against Preposition Stranding will prevent the outcome \*P X DP.<sup>22</sup> Consider some alternative derivations. If there were rightward movement first, nothing would prevent the grammar from deriving the ill-formed \*Adj X P N and \*N X P Adj split word orders. If A' or N' had moved first rightward, the remnant of the PP might have remained *in situ*, but this is not grammatical in Russian (though it is in Latin).<sup>23</sup> On the assumption that in Russian the Y'-Extraction can only occur from a phrase

---

<sup>22</sup> To explain the prohibition against Preposition Stranding for Latin, Ostafin assumed that prepositions are proclitics and must cliticize only to the DP they select and that DP must have some overt content at Spellout. However, to claim that prepositions in Russian are proclitics is not enough to account for the constraint against Preposition Stranding. Not all prepositions in Russian are phonologically proclitic (cf. *otnositel'no* 'as far as', *soglasno* 'according to', etc.). In general, the proclitic status of prepositions is not universal, while the constraint against Preposition Stranding is almost universal, English being a major exception. However, the investigation of Preposition Stranding goes beyond the scope of this dissertation; for now, it will suffice to assume that whatever principle rules out Preposition Stranding in Russian will explain the ungrammaticality of orders where the preposition is all the way at the right edge of the clause (e.g., \*A N P) or is not string-adjacent to at least a part of its complement (e.g., \*P X A N).

<sup>23</sup> I have noted in Section 5.2.1 the difficulty of ensuring leftward remnant movement in German if the remnant is created by extraction prior to remnant movement.

in FP (see below), it is guaranteed that the remnant will be in leftward scrambled position, never *in situ*. Note that this needs to be parameterized since in Latin the Y' evidently can extract from XP *in situ*. I assume this must have to do with the barriers relevant to Subjacency in this language. This is the second problem mentioned above, concerning bounding.<sup>24</sup> Though I cannot account for it precisely at this time, I will make the schematic proposal that Russian respects a greater number of barriers (or blocking categories) than Latin does. Alternatively, it is possible that in Latin the Y' can escape from XP *in situ* by first adjoining locally to that XP, and proceeding upward from there. In that case the parametric variation would concern this local adjunction: for Latin it would be possible, but for Russian it would not. I will call this informally the "Remnant in Situ" parameter, leaving open for now its precise formulation.

In summary: the following parameters are proposed for Scrambling in Russian (46):

- |      |                                                                           |                      |
|------|---------------------------------------------------------------------------|----------------------|
| (46) | Landing Sites: VP, IP;<br>Direction: Leftward, rightward.                 | FOR XP-SCRAMBLING    |
|      | Remnant <i>in Situ</i> : Yes/No<br>Category of Extracted Element: N', A'. | FOR SPLIT SCRAMBLING |

Postulating SPEC, FP as the unique landing site for a phrase in the first step of Split Scrambling can account for a great many structural facts, and at the same time can explain the special focus structure of split scrambling constructions.

## 5.6 Summary of Chapter 5

It has been shown in this chapter that discontinuous DPs and PPs in Russian obey several particular constraints, the most interesting of which are the Periphery Constraint, the One-Split-per-Clause Constraint, and the Preposition-First Constraint for split PPs. In order to seek a linguistic explanation for these restrictions, it was necessary to consider how such discontinuous

---

<sup>24</sup> Why is it possible to extract Y' out of the scrambled XP which is in SPEC, FP and not to violate barriers. There are several possibilities to explore. One is that FP does not inherit barrierhood from IP because it is not included into the extended projection of VP. Alternatively, it is allowed because adjunction to FP creates a segment which is a part of FP, not a barrier of its own.

constituents could be syntactically derived. Two types of analyses have been proposed in the literature: Split Scrambling as XP-Scrambling for Latin, and Double-Movement for German, Serbo-Croatian, and Modern Greek. Of the two, the Double-Movement analysis proposed in this chapter, offers the better explanation for Russian Split Scrambling, on the assumption that the landing site for the first movement is SPEC, FP and the landing site for the second movement is right-adjunction to FP.

This analysis is also motivated by the focus structure of split scrambling constructions which require a F(ocus)P. FP is a functional projection associated with Constituent Focus which is located above IP in the tree. The uniqueness of FP and its location in the tree (combined with standard constraints on movement) allow for a plausible grammatical explanation of the Periphery Constraint, the One-Split-per-Clause Constraint, and the Preposition-First Constraint. This analysis also permits suitable parameterization (bounding constraints, category constraints) to cover other languages which exhibit Split Scrambling.

In Chapter 6 it will be shown in more detail how the Double-Movement analysis of Split Scrambling in Russian is driven by Focus considerations.

## Chapter 6: Discourse Properties of Split Scrambling

|       |                                                                                                |     |
|-------|------------------------------------------------------------------------------------------------|-----|
| 6.1   | Introduction .....                                                                             | 227 |
| 6.2   | Functional Analyses of Discourse Properties of Word Order Variation in the<br>Russian DP ..... | 228 |
| 6.2.1 | Production Data: Sirotinina (1965) .....                                                       | 228 |
| 6.2.2 | Discourse Functions of Discontinuous DPs: Lapteva (1976) .....                                 | 234 |
| 6.3   | Functional Analysis of Split Scrambling in Polish (Siewierska, 1984) .....                     | 238 |
| 6.4   | Split Scrambling in Russian and the Syntax-Phonology Interface .....                           | 243 |
| 6.4.1 | Split Scrambling and Focus .....                                                               | 243 |
| 6.4.2 | The Periphery Constraint and the One-Split-per-Clause Constraint .....                         | 248 |
| 6.5   | Summary of Chapter 6 .....                                                                     | 251 |

## 6.1 Introduction

Like standard XP-Scrambling, Split Scrambling gives the appearance of being optional in the sense that the basic structure to which Split Scrambling applies is itself grammatical as a surface form. In Chapter 3, I have argued that Reinhart's (1995) theory of Scrambling motivated by Focus considerations can be applied to explain the driving force behind standard XP-Scrambling in Russian. XP-Scrambling serves the goal of removing a phrase from the domain of sentential Focus, that is, De-Focusing. This chapter hypothesizes that Split Scrambling is also driven by Focus requirements.

It has been noted in traditional Russian grammar that split scrambling constructions have a specific prosodic structure and they can have special semantico-pragmatic characteristics. Section 6.2 briefly summarizes the most important points of this functional approach to Split Scrambling. Sirotinina (1965) conducted a production study of various word orders within DP and provided some quantitative data on the distribution of Adj N combinations. Lapteva (1976) analyzed lexico-semantic classes of discontinuous DPs and showed that each class has special characteristics which are reflected in the prosody of the sentences in which the discontinuous DPs appear.

Another functional approach to Split Scrambling is exemplified by Siewierska's (1984) study of Split Scrambling in Polish. Siewierska identified special restrictions which split scrambling constructions in Polish obey, three of which, the Periphery Constraint, the One-Split-per-Clause Constraint, and the Preposition-First Constraint, are also applicable to Russian. In general, Polish split scrambling constructions have a special Focus structure since they are felicitous only in a doubly contrastive focus context. While Siewierska does not provide a formal account of Split Scrambling in Polish, her study presents an important background for the analysis of Russian Split Scrambling, which as will be argued in Section 6.4 is also driven by Focus requirements.

Section 6.4 elaborates on the Double-Movement analysis of Russian Split Scrambling of Chapter 5 as motivated by Focus requirements, along the lines of Reinhart's (1995) theory. Split Scrambling is associated with Constituent Focus, and I have argued that a special F(ocus)P must be projected in sentences with Split Scrambling. The first step of deriving Split Scrambling, XP-Scrambling, is triggered by the strong [-SS] feature, as described in Chapter 3. FP is projected higher in the tree than IP but lower than CP, and its SPEC position and right-adjoined position are used as landing sites for the subparts of the discontinuous constituents at the left and right periphery of the clause. This offers a possible grammatical explanation for the Periphery Constraint. Moreover, the uniqueness of FP in the clause entails that there can be only one potential discontinuous constituent per clause. Thus, the Double-Movement analysis of Split Scrambling in Russian proposed in Chapter 5 can provide a plausible grammatical explanation for the Periphery Constraint, the One-Split-per-Clause Constraint and the Preposition-First Constraint.

## 6.2 Functional Analyses of Discourse Properties of Word Order Variation in the Russian DP

### 6.2.1 Production Data: Sirotinina (1965)

As was shown in Section 5.5, it is generally assumed that the unmarked word order in the Russian DP is Adjective – Noun when the adjective is adjacent to the noun. However, discontinuous DPs (and PPs) occur very productively in two registers of Russian, spoken Colloquial Russian and literary Russian. Linguists in Russia who work on Colloquial Russian, such as Sirotinina, provide a descriptive account of such constructions within the general discussion of Adj – N and N – Adj orders.

Sirotinina (1965) carried out a corpus analysis of spoken Colloquial Russian. In her tape-recorded materials of naturally occurring speech she found 899 cases of adjectival modifier –

head noun constructions, both continuous and discontinuous. She classified these occurrences from the point of view of *logical stress* which is equivalent to the modern notion of Focus. If the entire Adj + N (or N + Adj) combination conveys *new information*, then the head noun carries the logical stress:<sup>1</sup>

- (1) On očēn' ljubil černyj KOfe.  
He very liked black coffee  
'He liked black COFfee very much.'

An adjective in the new information DP can only be stressed if the adjective by itself carries this new information:

- (2) Buržuazija tože nikogda ne vela s nami ČESTnoj bor'by.  
Bourgeoisie also never not carried on with us honest struggle  
'Bourgeoisie also never carried on HOnest struggle with us.'

In 319 cases the DP was not stressed at all because it wasn't conveying new information:

- (3) Ja doma nikogDA ne p'ju černyj kofe.  
I at home NEver not drink black coffee  
'I NEver drink black coffee at home.'

Sirotinina's statistical data are summarized in Table 15. It is important to note that in these data she does not separate continuous and discontinuous Adj – N and N – Adj word orders, that is, these data represent both types of word order collapsed together:

Table 15. Word Orders in Colloquial Russian DP (Sirotinina, 1965)

|                               | ADJECTIVE<br>– NOUN | NOUN –<br>ADJECTIVE | TOTAL |
|-------------------------------|---------------------|---------------------|-------|
| NO STRESS AT ALL <sup>2</sup> | not available       | not available       | 319   |
| STRESS ON THE N               | 326 (63%)           | 54 (88%)            | 380   |
| STRESS ON THE ADJ             | 155 (30%)           | 7 (12%)             | 162   |
| BOTH STRESSED                 | 38 (7%)             | –                   | 38    |
| TOTAL:                        | 518                 | 61                  | 899   |

<sup>1</sup> Examples (1) - (4) are actual sentences from Sirotinina's corpus.

<sup>2</sup> Sirotinina does not give separate numbers for the Adj N and N Adj combinations in the DP group without stress.

As can be seen from Table 15, stress is more often on the noun than on the adjective regardless of order. Stress on the adjective is more common when it precedes the noun than when it follows the noun (both absolutely and as a proportion of each word order). Adj – N order is eight times more common than N – Adj order. To explain these facts, Sirotinina suggests that there is a correlation between pre- and postnominal position of the adjective and its “communicative role”<sup>3</sup> in the sentence: she assumes that prenominal modifiers are usually communicatively significant while postnominal modifiers tend to be communicatively insignificant (54 cases out of 61 in Sirotinina’s sample of postnominal adjectives). To be communicatively insignificant for an adjective means that it does not contribute anything special to its head noun interpretation, or that it is known (presupposed) by both the speaker and the listener. Communicatively insignificant adjectives usually do not carry the logical stress. These features are the same for both spoken Colloquial and literary Russian.

Sirotinina argues that in Colloquial Russian, postnominal adjectives may have another function which is not possible in the written language. An adjective may be added to the already produced part of a sentence as an afterthought. For example, in (4a), the topic of the conversation is *musor* ‘the garbage-ACC’ and it is obvious that a cargo truck is necessary to remove it so there is no need for the adjective *guzovoj* ‘cargo-PREP’. Likewise, in (4b), the word *šapku* ‘hat-ACC’ already contains the semantic notion of warmth which makes the redundant adjective *tepluju* ‘warm-ACC’ an afterthought:

- (4) a. Na mašine segodnja uvezli guzovoj.  
 on car-PREP today took away cargo-PREP  
 ‘[pro] took away [the garbage] on the cargo car today.’
- b. Na ulice xolodno. Šapku naden’ tepluju.  
 in street cold. Hat-ACC put on warm-ACC  
 ‘It is cold outside. Put on a warm hat.’

A sentence like (4b) would not occur except in conversation.

---

<sup>3</sup> Sirotinina uses the so-called *functional sentence perspective analysis* advocated by the traditional Prague school of linguistics. See Bailyn (1995) for discussion of this school.

Sirotinina's descriptive facts about the properties of the different word orders in the Russian DP can be summarized in Table 16:

**Table 16. Properties of the Word Orders in the DP in Spoken Colloquial Russian**

| ADJECTIVE'S PROPERTIES<br>(WHEN NON-PREDICATIVE) | ADJECTIVE – NOUN                       | NOUN – ADJECTIVE                                       |
|--------------------------------------------------|----------------------------------------|--------------------------------------------------------|
| COMMUNICATIVE ROLE IN<br>THE CLAUSE              | usually significant                    | usually insignificant                                  |
| CLOSENESS TO THE NOUN                            | a single unit with the N               | a separate unit from the N                             |
| INFORMATION CONVEYED                             | new                                    | known (presupposed)                                    |
| CAN CARRY LOGICAL<br>STRESS                      | +                                      | -                                                      |
| SEMANTICS                                        | contributes to the N<br>interpretation | does not contribute to the<br>N; or is an afterthought |

The facts about the properties of different word orders in the Russian DP presented in Table 16 provide empirical motivation for the claims that the underlying D-Structure (Bailyn, 1995) and unmarked surface word order in the Russian DP is Adj – N where the adjective is adjacent with the noun. Communicative significance of the adjective in the clause is the usual case, and it is reflected in the stress pattern and in the positioning of the adjective preceding and adjacent to the head noun it modifies.

Sirotinina found that the Adj – N word order accounts for approximately 90% of all DPs in which an adjective modifies a noun (see Table 16).<sup>4</sup> In the derived word orders grammatical relations are not changed and rarely become ambiguous. What is changed in the derived word orders is only the unity of the phrase and the Focus structure of the sentence. To some extent, emphatic stress and intonation can be used as an alternative way to achieve the goal of logical stress while leaving the word order intact. Stress and intonation, however, cannot produce

<sup>4</sup> Sirotinina does not give statistical data in terms of numbers of tokens for her spoken sample. Instead she specifies that there were 15 kilometers of tape recorded with the speed of 19.5 centimeters per second. Recall however that her corpus was extremely small – 899 cases of DPs where an adjective modifies a noun. This number is not large enough to be truly representative, but approximate numbers are sufficient for present purposes.

communicative insignificance; the only way to do this is to change word order. However, this is more likely to be true only of languages with fairly free word order. In fixed word order languages like English, a word can be made insignificant by shifting stress to a different one, especially if the insignificant one would receive default stress and is being deprived of it (e.g., He wore a réd coat.) Default stress is used more commonly in Russian, and is not overridden as in English, because word order can be altered instead to achieve the same effect.

When discussing the properties of the discontinuous cases Sirotinina observes that adjectival modifiers separated from their nouns in examples like (4) above are understood as afterthoughts and therefore, their discontinuous position is justified by stylistic factors. However, in her opinion, some postposed adjectival modifiers separated from their nouns acquire a somewhat predicative interpretation. Recall from the discussion in Section 2.4.1 (Chapter 2, example (31) repeated here as (5)) that a combination of a noun and a prenominal modifying adjective which agrees with it is a DP, as shown in (5a), but can be a sentence when the adjective is postnominal, as in (5b):

- (5) a. *Tixaja noč'*  
       quiet night  
       'a quiet night'
- b. *Noč' tixaja.*  
       night quiet  
       'The night is quiet.'

(5a) *tixaja noč'* 'a quiet night' is usually understood as a constituent headed by the noun *noč'* 'night' which is modified by a prenominal adjective *tixaja* 'quiet', the default word order for such combinations in Russian. It is pronounced with a neutral gradually falling intonation and as a single phonological unit. In contrast, the combination *noč' tixaja* 'the night is quiet' in (5b) can be interpreted as a full sentence with the predication relation between the noun subject and the adjectival predicate where the present tense copula is zero. As such, it is pronounced as two phonological units, with rising and falling intonation contours, with a pause in between which is often represented as a hyphen in the orthography. Example (6a) is similar to (5b) in that the noun *noč'* 'the night-NOM' and the AP *na redkost' burnaja* 'exceptionally wild-NOM' are on the edges of

the clause separated from each other by a lexical verb which could be construed with a copula meaning. In contrast to (6a), example (6b) does not allow a potential predicative interpretation:

- (6) a. Noč' vypala na redkost' burnaja. (Leonov 'Russian Woods')  
 night-NOM occurred exceptionally wild-NOM  
 lit. 'The night occurred exceptionally wild.'
- b. Vrača t<sub>1</sub> boitsja malen'kij rebenok starogo t<sub>1</sub>.  
 doctor-GEN is afraid small child old-GEN  
 'The small child is afraid of the old doctor.'

The predicative interpretation is only possible in sentences with copula-like verbs (e.g., *vypala* 'occurred' in (6a)) and when the discontinuous constituent is in NOM, which is one of the two default cases for non-verbal predicates in Russian (the other two being INSTR). For these reasons, the predicative interpretation is not available for (6b). While I still assume that examples like (6a) are derived via Split Scrambling and only acquire some predicative meaning by analogy with true predicative constructions, I will avoid using such sentences in the discussion that follows.

Turning now to preposed adjectives separated from their nouns, Sirotinina reports that these carry logical stress and convey new information. Thus, in example (7), the preposed adjective *starogo* 'old-ACC' separated from its noun *vrača* 'the doctor-ACC' conveys new information in the sense that the presupposition is such that there are a few doctors that the child visits regularly and the assertion is that out of those, he is afraid of the old one:

- (7) Starogo<sub>1</sub> boitsja malen'kij rebenok t<sub>1</sub> vrača.  
 old-GEN is afraid small child doctor-GEN  
 'The small child is afraid of the old doctor.'

Sirotinina concludes her discussion with the claim that from the purely syntactic point of view, discontinuous Adj X N and N X Adj word orders behave as their continuous counterparts Adj N and N Adj orders and should be analyzed as such. What differs is their discourse status. We will see in Section 6.4 that the fact that split scrambling constructions are discourse dependent follows naturally from their Constituent (possibly, contrastive) Focus structure.

### 6.2.2 Discourse Functions of Discontinuous DPs: Lapteva (1976)

Lapteva (1976) in her book *Russkij Razgovornyj Sintaksis* ('Russian Colloquial Syntax') clarifies some points raised by Sirotinina and pays special attention to discontinuous DPs. For her analysis, the following classification (8) for adjective placement is important:

- (8)
- a. adjacent to the noun and preposed;
  - b. adjacent to the noun and postposed;
  - c. discontinuous with the noun and postposed;
  - d. discontinuous with the noun and preposed.

Lapteva looks for a correlation between the function the adjective fulfills and its position in the clause and points out that there is no one-to-one match between the function and the position of the adjective, since the first three cases (8a-c) overlap in some of their functions. For example, the postposed adjacent adjective, as in (9a), and the postposed discontinuous adjective, as in (9b), coincide in their communicative role (in cases where the adjective is as communicatively significant as the noun). If the discourse circumstances as reflected in the focus structure of the clause were equal, a speaker would tend to choose a less marked example (9a). However, in a situation where a Constituent Focus is required on the adjective *celuju* 'whole-ACC', (9b) may be preferred. (Note that Lapteva assumes that non-adjacency is the marked case.)<sup>5</sup>

- (9) a. Vam lekciju celuju nado pročitat' na ètu temu.  
you-DAT lecture-ACC whole-ACC need to give on this topic
- b. Lekciju vam nado pročitat' CEluju na ètu temu.  
lecture-ACC you-DAT need to give WHOLE-ACC on this topic  
'You need to give a WHOLE lecture on this topic.'

The only exception is (8d), a preposed adjective discontinuous with the noun, which has a unique function and does not share it with any other construction in this four-way classification. Separating the adjective from its noun and preposing it is used when the adjective conveys important information to fulfill two functions: one when the adjective is equally important with the noun or when it is even more important than the noun. Lapteva considers each possible function of (8d) in detail. I will briefly review her discussion.

---

<sup>5</sup> Examples (9) - (14) are from Lapteva.

The first possible semantico-pragmatic class of sentences with a preposed discontinuous adjective is cases where the adjective carries most of the semantic content of the split DP. Under these circumstances the noun is to some extent redundant because its meaning is more or less obvious from the lexical meaning of the adjective. Thus, in (10a), *borodinskogo* 'Borodinsky-GEN' refers to a particular type of bread in the context of grocery shopping, and the noun simply fills in a structural position. It has no real semantic role and is just a syntactic place holder. This is carried to the extreme in (10b). Finally, another possible connotation of this construction is the contrastive meaning, as in (10c). (Here and in examples below boldface represents communicative significance):

- (10) a. **Borodinskogo** u vas net **xleba**?  
 Borodinsky-GEN at you not bread-GEN?  
 'Do you happen to have the Borodinsky bread?'
- b. **Užasno urodlivyj** ona imeet **vid**.  
 awfully ugly-ACC she has appearance-ACC  
 'She looks very ugly.'
- c. Est' formuly pervaja, vtoraja, tret'ja, a **četvertoj** net **formuly**.  
 is formula first second third but fourth-GEN not formula-GEN  
 'There are the first, second and third formulas but there is no fourth formula.'

Such sentences have a distinct intonation pattern: the stress falls on the adjective, the middle part of the sentence is pronounced unstressed (and rising intonation in (10a)), and the noun may or may not bear a secondary stress.

The second possible class with a preposed discontinuous adjective consists of cases where both the adjective and the noun are communicatively significant and (in contrast to (10)), the noun is not redundant, as exemplified in (11):

- (11) **Gotovyj** ja inogda **pokupaju ščavel'**.  
 ready-ACC I sometimes buy sorrel-ACC  
 'I sometimes buy ready-to-use sorrel.'

I turn now to Lapteva's discussion of the postposed adjective discontinuous with the noun (8c). This fulfills two very different functions. The first function is addition of an insignificant property to the noun that the adjective modifies. The speaker did not have an initial

intention to include this adjective in his proposition, it comes in later as a kind of afterthought (as discussed by Sirotinina above). Such an adjective usually comes last in the sentence, it is not stressed, sometimes it is pronounced faster than the rest of the sentence and often it is preceded by a pause (#), as in (12):

- (12) a. **Platok** ja tože vzjala # teplyj.  
 shawl-ACC I also took warm-ACC  
 'I also took a warm shawl.'
- b. Oni xuliganjat, a zdes' rebjata stojat # malen'kie.  
 they make a row but here children-NOM are small-NOM  
 'They are making a row but there are small children here.'

The second function, the opposite to the first one, of the postposed adjective discontinuous with the noun is importance. In this case the adjective was initially planned in the proposition by the speaker. It conveys communicatively significant information (identified by boldface) which needs to be distinguished from the information conveyed by the noun. It is never pronounced faster, there is no pause in front of it, and it is always stressed, as shown in (13):

- (13) a. **Devočka** emu pomogaet staršaja.  
 girl-NOM him helps older-NOM  
 'The older girl helps him.'
- b. Ja vam sejčas berézu zàvaljú suxúju.<sup>6</sup>  
 I you now birch tree-ACC cut down dry-ACC  
 'I will cut down a dry birch tree for you now.'

Lapteva observes that the syntax is ambiguous with respect to the first and second functions of (8c); it is the phonology and communicative structure of the sentence that disambiguate these two functions.

In general, according to Lapteva, constructions with discontinuous constituents (with preposed or postposed adjectives separated from the noun) have two important properties. First, the discontinuous use of adjectives is licensed by the communicative perspective of a sentence

---

<sup>6</sup> The symbols ' and ` represent primary and secondary stress respectively. I have marked these only in the examples relevant to the current discussion, not throughout the dissertation.

where the parts of the discontinuous constituent are placed in two different domains: one in the given information (the Theme) domain and one in the new information (the Rheme) domain. Second, discontinuous constituents are used productively in spoken speech where the given vs. new information distinction tends to be encoded differently from the written form of the language. Spoken speech is organized rhythmically, with unstressed and stressed syllables alternating. In many cases in speech a discontinuity is introduced into the sentence in order to fulfill this rhythmic pattern. Thus, when a discontinuous postposed adjective is equivalent in its function to an adjacent postposed adjective, the former may be preferred because it enforces the alternating rhythmic pattern. In (13b) (repeated here as (14a)), the change of the discontinuous word order into a standard continuous Adj N (14b) will result in a violation of the alternating rhythmic pattern: the two syllables in italics are unstressed and at the same time are adjacent to each other.

- (14) a. Ja vam seĉas *berézu*            zàvaljú *suxúju*.<sup>7</sup>A      ALTERNATING RHYTHMIC PATTERN  
 I you now birch tree-ACC cut down dry-ACC
- b. Ja vam seĉas zàvaljú *suxúju berézu*.      VIOLATION OF THE ALTERNATING PATTERN  
 I you now cut down dry birch tree  
 'I will now cut down a dry birch tree for you.'

Sirotinina (1965) and Lapteva (1976) conducted their research within the framework of traditional descriptive Russian linguistics and as a result, they concentrated on the semantic and communicative functions of constructions with discontinuous DPs and did not discuss how these properties relate to the syntactic characteristics of such constructions. In Chapter 5 I proposed a syntactic analysis of Split Scrambling in Russian, the Double-Movement analysis, and in what follows (see Section 6.4 below) I will attempt to show that it is motivated by Focus properties of split scrambling constructions of the kind reviewed here. I will briefly review a different attempt to provide a functional explanation for Split Scrambling in Polish, a Slavic language closely

---

<sup>7</sup> Notice that the discontinuous Adj X N order *suxúju zàvaljú berézu* 'dry cut down birch tree' would also introduce an alternating rhythmic pattern into the sentence. Rhythmic considerations thus do not choose between these two orders.

related to Russian. It is important because of many striking similarities between split scrambling constructions in the two languages.

### 6.3 Functional Analysis of Split Scrambling in Polish (Siewierska, 1984)

The Polish facts described by Siewierska (1984) are very interesting for the present project because they are directly parallel to the Russian split DPs and PPs. Discontinuity within the NP<sup>8</sup> (15a) and PP (15b) in Polish can be illustrated with the following sample sentences:

(15) a. Piękny mają ogród.  
 beautiful have garden  
 'They have a beautiful garden.'

b. Do mojego włamali się mieszkania.<sup>9</sup>  
 to my broke in REFL flat  
 'They broke into my flat.'

(Siewierska 1984: (2)-(3))

Just as in Russian, the constructions exemplified in (15) are typical of two registers of Polish, literary prose and spoken language. Since Polish, like most Slavic languages, has rich inflectional morphology it is not difficult to construct the meaning of such sentences: the modifying adjective and the head noun agree in grammatical features of number, gender and case.

Siewierska argues that NP and PP discontinuity in Polish is a means of "highlighting" the constituents of the phrase, particularly for purposes of contrast. The two most robust constructions that allow discontinuous NPs and PPs in Polish are contrastive contexts involving constituent negation and gapping (16a), and doubly contrastive contexts (16b), where not only the original pairing of the constituents of the phrase is denied but a new pairing for both is suggested:

---

<sup>8</sup> In this section I will follow Siewierska in referring to split NPs rather than DPs. Her article appeared before Abney (1987) proposed the DP-hypothesis.

<sup>9</sup> The reflexive particle *się* is usually a clitic that cliticizes onto the verb and thus it is not a part of the discontinuous PP.

(16) a. Nie buty miała fajne, tylko nogi.  
not shoes had nice only legs  
'It was not her shoes which were great, but her legs.'

b. - Podobno mają piękny dom.  
apparently have beautiful house  
'Apparently they have a beautiful house.'

- Nie! Piękny mają ogród. Dom mają kiepski.  
No! beautiful have garden. house have crummy  
'No! They have a beautiful garden. The house is crummy.' (Siewierska 1984: (4)-(5))

In non-contrastive constructions, discontinuous NPs and PPs are sometimes acceptable, as in (17a), but more often are marginal at best, as in (17b):

(17) a. [A fellow student has just come out from an exam.]  
Łatwe dostałaś pytania?  
easy get questions  
'Did you get easy questions?'

b. - W rezultacie kupiłaś coś fajnego?  
in result bought something nice  
'Did you buy something nice in the end?'

- \*?Tak. Fajną kupiłam sukienkę  
Yes. nice I brought dress  
'Yes. I bought a nice dress.' (Siewierska 1984: (7), (9))

Siewierska shows that NP and PP discontinuity in Polish is not necessarily motivated by the principle which usually motivates word order choices in this language, i.e., that given information precedes new irrespective of the grammatical function of the constituents involved. Example (17a) is the first utterance in the discourse and none of the constituents, strictly speaking, can be regarded as given. Looking for an alternative explanation for the motivation of phrasal discontinuity in Polish, she proposes the following six descriptive generalizations (18) that characterize the usage of discontinuous NPs and PPs (see (16) -(17)):

- (18) (a) They occur only in clauses where the subject is expressed only by agreement suffixes on the verb (i.e., *pro*-drop clauses);
- (b) Discontinuous NPs typically have only one modifying adjective; sequences of modifiers are very rarely discontinuous;

- (c) No Preposition Stranding is allowed, and no part of a prepositional object may precede the preposition (cf. the Preposition-First Constraint, Section 5.2 above), as the contrast between (19a) and (19b) below shows;
- (d) The split parts of the discontinuous NP/PP are always on the periphery of the clause, one part sentence-initial, while the other is sentence-final, and they must be separated by the verb (cf. the Periphery Constraint, see Section 5.2 above), as illustrated in (20) below;<sup>10</sup>
- (e) Typically, only very short constituents (pronouns, clitics, adverbials) can intervene between the verb and the final constituent. Direct and indirect objects are prohibited in this position, as the ill-formedness of (21) illustrates;
- (f) Only one split per clause is allowed.
- (19) a. O tej mówiliśmy dziewczynie.  
about this spoke-we girl
- b. \*Dziewczynie mówiliśmy o tej.  
girl spoke-we about this  
'We spoke about this girl.' (Siewierska 1984: (15))
- (20) \*Kupili piękny Markowi obraz.  
bought beautiful Mark painting  
'They bought Mark a beautiful painting.' (Siewierska 1984: (16))
- (21) \*Z tej piła mleko szklanki.  
from this drank milk glass  
'She drank milk from this glass.' (Siewierska 1984: (18))

How can these restrictions in (18) be derived? Siewierska argues that the constraints in (18a) and (18e) follow from processing considerations. Discontinuous constituents are harder to process than continuous ones, and to minimize the processing load split NPs and PPs tend to be in short simple clauses. The restriction (18f) is claimed to follow from the combination of (18a) and (18e). Commenting on restriction (18c), she claims that split PPs are less acceptable than

<sup>10</sup> Note that the fact that they must be separated by the predicate will fall out of the Periphery Constraint, assuming that each clause has to have a predicate.

split NPs, and speculates that this may be because the constituents within the PP are more closely bound than those within the DP.

However, Siewierska claims that a processing explanation is not sufficient to account for restriction (18d), i.e., the concerning the location of the split parts of the discontinuous phrase. Here is where the Topic vs. Focus distinction becomes important in Siewierska's analysis. The sentence-initial position in Polish is the unmarked position for the topic of the clause, while the final one is the focus position. Discontinuity is then due to the assignment of topic and focus functions to the parts of the NP or PP. Therefore, Siewierska argues that the placement of the parts of the discontinuous phrase is an automatic consequence of their pragmatic functions, although she claims that the pragmatic considerations are more complex than is sometimes implied.

The motivation of topic vs. focus assignment explains one of the two main constructions in which split DPs and PPs are used in Polish, the doubly contrastive contexts (16b). On the other hand, there are some cases where a direct correlation with standard pragmatic functions cannot be found but discontinuity is nevertheless possible. This is the case when topic (given information) follows focus (new information) in a clause, as in (17a). Siewierska suggests that discontinuity in such cases is warranted by the marked assignment of topic and focus. The sentence-initial focus is marked with emphatic stress. This does not necessarily mean that this focus is contrastive; it signals that the focus of the clause has been placed in a marked position. However, the topic placed in the marked sentence-final position, which is standardly used for a new information focus, can now have two functions. It can convey new information or it can be contrastive. Siewierska concludes that in spoken Polish in the doubly contrastive context, both parts are contrastive; in other contexts, the part which conveys new information (whether it is the default focus or the marked topic) is emphasized.

In literary prose, however, both parts of the split DP or PP can be foci, as shown in (22):

- (22) Znowu nowych wprowadzi do wyobraźni znajomych.  
 again new introduce into imagination acquaintances  
 'His imagination will be stimulated by new acquaintances.'

The adjective *nowych* 'new' is assigned focus because it conveys new information while the sentence-final *znajomych* 'acquaintances' is a focus due to its position in the clause. This is a manifestation of the same phenomenon in literary prose as in speech, i.e., double prominence. Since the topic and focus are the most prominent constituents in the clause, phrasal discontinuity signals double prominence. This appears to be the overall function of phrasal discontinuity in Polish, according to Siewierska.

Siewierska does not propose a formal syntactic analysis of Polish split NPs and PPs, and the complexities are such that this is scarcely a predictive theory as yet, but her analysis of the NP and PP discontinuity in Polish is very interesting for our purposes because the Polish facts are very much like the Russian facts (Chapter 5). In both languages NP and PP discontinuity is allowed in speech and literary prose (in Russian in poetry as well). Just as Siewierska suggests for Polish, Russian Split Scrambling appears to be directly related to the assignment of a focus structure to the clause. Some of the restrictions which constrain Split Scrambling in Polish are applicable to Russian, such as (18b, c, f). Thus, sequences of modifiers do not get split (cf. (4a), Chapter 5). No Preposition Stranding is allowed, and the Preposition-First Constraint applies (cf. (4e), Chapter 5). Only one split per clause is allowed (cf. (4d), Chapter 5).

Some other restrictions in Polish do not apply in Russian, such as (18a, e). Russian usually retains pronouns in subject position and does not rule out the usage of direct or indirect objects between the verb and the sentence-final part of the split constituent. In fact, there is no apparent pressure in Russian to keep the intervening portion of the sentence short or syntactically simple. The two main functions of the phrasal discontinuity in Polish, constituent negation (or gapping) and doubly contrastive contexts, are not obligatorily required for split DP and PP cases in Russian; initial (opening) utterances of the discourse with split constituents are quite common. The Periphery Constraint (18d) although quite strong in Russian is not absolute, in contrast to



- (24) (a) Generalized Stress Rule assigns default sentential stress to a word;  
 (b) Basic Focus Rule specifies the constituent with default sentential stress as focused;  
 (c) Focus can project up in the tree;  
 (d) Stress, Focus and syntactic processes like Scrambling interact at the stage where both the syntactic tree and stress are visible. This is enriched PF construed as a syntax-phonology interface at which the full syntactic tree is represented including all phonological phenomena like stress, feature erasure, and others.

In Chapter 3 this theory was applied to Russian in order to provide an explanation of how standard XP-Scrambling and Focus interact. To reiterate briefly: In the unscrambled sentence (25a), the sentential Focus is assigned by default to the most embedded constituent, the direct object *knigu* 'the book-ACC', because it is in the default position for the main stress in the sentence. In (25b), XP-Scrambling serves the function of removing this direct object from its D-Structure position in which it otherwise would receive the sentential Focus. This Scrambling is triggered by a strong feature [-SS] on the phrase that scrambles. An independent operation may assign a marked stress to some constituent in the clause which can be any constituent, including the scrambled one, as shown in (25c), resulting in a structure with an additional Constituent Focus:

- |         |                                                                                               |             |
|---------|-----------------------------------------------------------------------------------------------|-------------|
| (25) a. | Mal'čik čitaet KNIGu.<br>boy-NOM reads [BOOK-ACC]                                             | D-STRUCTURE |
| b.      | Mal'čik knigu čitAet.<br>boy-NOM book-ACC[-SS] READS                                          | SCRAMBLED   |
| c.      | Mal'čik KNIGu čitAet.<br>boy-NOM [BOOK-ACC][-SS][+CS] READS<br>'The boy is reading the book.' | SCRAMBLED   |

In general, a derivation will proceed as follows. First, Focus structure (i.e., given and new information) is established by discourse context and communicative intentions. Second, prosodic features [-SS] and [+CS] are assigned, on this basis, to certain underlying constituents. If

only [-SS] is assigned and if the constituent with [-SS] is in the most embedded position in a sentence where it would receive [+SS] by default sentential stress assignment, XP-Scrambling occurs triggered by [-SS]. A derivation would crash if the stress rule assigns [+SS] to a phrase marked [-SS]. However, if XP-Scrambling first removes this phrase, the derivation comes through.<sup>11</sup>

In addition, [+CS] can be assigned to some constituent in a sentence whether or not some other constituent bears [-SS]. [+CS], just like [+SS], but unlike [-SS], is not a strong feature and does not trigger Scrambling; it is also compatible with [+SS] and so the constituent can be marked with both and will receive a marked stress. [+CS], in contrast to [+SS], does not project up in the tree. If [-SS] is assigned to one constituent and [+CS] is assigned to a different one, then XP-Scrambling occurs for the first constituent and the second one receives a marked stress. If [+CS] is assigned to the same constituent as [-SS], XP-Scrambling moves this constituent which will also receive a marked stress due [+CS].

Split Scrambling is simply the syntactic realization of one of these feature assignment. Split scrambling constructions arise when [+CS] is assigned to a subpart of the constituent which is assigned [-SS]. While [+CS] cannot project beyond the limits of the XP, it can project within the XP. Projection may be suited to the discourse context; if not, the two subparts of the XP must be separated because otherwise the Constituent Focus will improperly project up to the whole XP. The XP-scrambled constituent must be split, by postposing one subpart or the other, which makes the second step in Split Scrambling obligatory.

Let us turn to the particular examples with Split Scrambling discussed in Section 5.5: the sentences in (25a, b) and (26a, b) (repeated from Chapter 5).

- (25) a. Černyj on ljubit kofe.  
 black-ACC he-NOM likes coffee-ACC

<sup>11</sup> It is perfectly possible that instead of ordered rule application the derivation consists of simultaneous constraint satisfaction, with suitable adjustment of details. This difference is not important for the discussion to follow, and I will not elaborate it here. (See also footnote 20, Chapter 3.)

b. Kofe on ljubut černyj.  
 coffee-ACC he-NOM likes black-ACC  
 'He likes black coffee.'

(26) a. Na bol'suju položi jabloki tarelku.  
 on big-ACC put apples-ACC plate-ACC

b. Na tarelku položi jabloki bol'suju.  
 on plate-ACC put apples-ACC big-ACC  
 'Put apples on the big plate.'

These sentences have special prosodic patterns which manifest themselves in different combinations of stress and pauses, as shown in (27):

- (27) (a) (P) Adj X N: N is stressed and pronounced without a pause before it;  
 (b) Adj X # N : Adj is stressed, there is a pause before N, N is pronounced in a lower tone;  
 (c) (P) Adj X N: both stressed;  
 (d) (P) N X Adj: A is stressed and pronounced without a pause before it;  
 (e) (P) N X #A: N is stressed, there is a pause before Adj, Adj is pronounced in a lower tone;  
 (f) (P) N X Adj: both stressed.

The double-stressed prosodic structures (27c) and (27f) are very rare. For the remaining four structures, all possible combinations of stressing one subpart of the discontinuous phrase are available. The special stress can be assigned to either the Adjective or the Noun; and it can be either on the left or on the right. The six possible combinations of stress and pause assignment in (27) will result in six possible focus structures for (25) and (26), summarized in Table 17:

Table 17. Possible Focus Structures for Split Scrambling Constructions in Russian

|             | RIGHT FOCUS                                        | LEFT FOCUS                                         | DOUBLE FOCI                                        |
|-------------|----------------------------------------------------|----------------------------------------------------|----------------------------------------------------|
| ADJ ... N   | <u>Černyj</u> on ljubit <u>KOfe</u> .              | <u>ČERnyj</u> on ljubit <u>kofe</u> .              | <u>ČERnyj</u> on ljubit <u>KOfe</u>                |
| N ... ADJ   | Kofe on ljubit <u>ČERnyj</u> .                     | <u>KOfe</u> on ljubit <u>černyj</u> .              | <u>KOfe</u> on ljubit <u>ČERnyj</u> .              |
| P ADJ ... N | <u>Na bol'suju</u> položi jabloki <u>taRELku</u> . | <u>Na bol'ŠUju</u> položi jabloki <u>tarelku</u> . | <u>Na bol'ŠUju</u> položi jabloki <u>taRELku</u> . |
| P N ... ADJ | <u>Na tarelku</u> položi jabloki <u>bol'ŠUju</u> . | <u>Na taRELku</u> položi jabloki <u>bol'suju</u> . | <u>Na taRELku</u> položi jabloki <u>bol'ŠUju</u> . |

In this sense, Split Scrambling, on a par with XP-Scrambling, is an operation used to serve Focus purposes. However, these Focus concerns are different for XP-Scrambling and Split Scrambling: the former just separates the sentences into two parts and only one of them is specified with respect to sentential Focus; the latter produces a special Constituent Focus structure which makes such sentences felicitous.

The considerable explanatory power of the Double-Movement analysis of Split Scrambling, proposed in Chapter 5, crucially depends on postulating a particular non-recursive functional projection above IP. I have tentatively identified this with F(ocus)P, a functional projection which is inherently associated with the focus organization of a sentence. Are there any independent arguments in favor of postulating FP in the grammar of Russian? It is of interest that Androutsopoulou (1997) (see Section 5.3.5) argues for a FP as the best way to account for her Focus movement analysis of Adjective Displacement in Modern Greek. For Russian, King (1993) proposes an analysis of *èto* cleft construction in which the pronoun *èto* is followed by a clause with the focused initial phrase (see the structure in (17), Chapter 2 above) :

(28) a. Èto BOris vypil vodku.  
 it Boris-NOM drank vodka-ACC  
 'It was Boris who drank the vodka.'

b. Èto VODku Boris vypil.  
 it vodka-ACC Boris-NOM drank  
 'It was the vodka that Boris drank.'

(King 1993: (43))

King proposes that the cleft pronoun *èto* is in SPEC, F(ocus)P; F<sup>0</sup> is null and contains only a focus feature which it assigns to its complement, and this complement is the focus of the cleft construction (see also discussion in Section 2.3.2).

#### 6.4.2 The Periphery Constraint and the One-Split-per-Clause Constraint

Split scrambling constructions are licensed by a particular Focus structure, i.e., they require a Constituent Focus on one of the subparts of the discontinuous constituent. I argued that the first step in deriving split scrambling constructions consists of XP-Scrambling of a phrase which, in contrast to other instances of XP-Scrambling (see Chapter 2), is moved into SPEC, F(ocus)P.<sup>12</sup> FP is projected only in the sentences where it is required by special Focus structure. It is projected high in the clause, higher than IP, which means that the subpart of the phrase which is spelled out in SPEC, FP, is going to be on the left outermost edge of the clause. The second step in deriving Split Scrambling in Russian consists of extracting an element out of the scrambled phrase into the right FP-adjoined position. Note that no other landing site is possible from which it can c-command its trace. The subpart of the discontinuous phrase which is spelled out to the right, is thus also on the outermost edge of the clause. Thus, postulating FP at the top of the clausal tree structure allows a plausible grammatical explanation for the Periphery Constraint.<sup>13</sup>

However, recall that the Periphery constraint is not an absolute restriction but rather a strong tendency: There do exist examples like (9b), (13b) above in which the subparts of the discontinuous constituent are not on the absolute edges of the clause. This calls into question the syntactic explanation of the constraint. Squishy (non-absolute) constraints are often attributed to

---

<sup>12</sup> If the second step, rightward extraction of Y', does not take place, it is not possible to establish whether a single leftward scrambled XP is in SPEC, FP or is adjoined to IP. In case of multiple scrambling, the top XP might be under FP or IP while all lower ones will be under IP; see example (46), Chapter 5, above.

<sup>13</sup> Truckenbrodt (1995) argues for two Focus positions, one at each edge of the clause, for a number of Bantu languages.

processing problems rather than to the grammar *per se*, and this possibility should obviously be considered here.

Perhaps the parser likes to have the split elements in very prominent positions, to overcome the greater processing difficulty of the split scrambling construction, or to provide clearer cues that it is a split scrambling construction. The viability of the constraint would result because an occasional exception would stretch the capacity of the processor, but would not necessarily be completely beyond its ability. This would have to be assumed that the processing limitation is taken more seriously in Polish than in Russian. But such variability is not unknown. For instance, the Nested Dependency Constraint applies more strictly in English than in Swedish (Engdahl, 1980).

On the other hand, it is not impossible to account for the softness of the Periphery Constraint within the competence grammar. AN additional application of XP-Scrambling would have to be postulated to account for cases where phrases scrambled to a position outside, and therefore above, the FP containing the split constituent. Possibly, this raising of an element beneath FP violates Subjacency. Alternatively, it is not unreasonable to assume that the Scrambling of XP outside of a split scrambling configuration is grammatical, and even processable, but is rare because it presupposes a very intricate Focus structure which would only rarely be warranted by the discourse context. To summarize: postulation of the FP projection explains why split elements are usually peripheral, but there are two possible accounts for the occasional exceptions. I will return to the discussion of Periphery Constraint in Chapter 7 in which I describe sentence processing experiments designed to investigate processing of split scrambling constructions in Russian.

Finally, let us consider the One-Split-per-Clause Constraint. Note that Siewierska (1984) (Section 6.3) derives this restriction for Polish from two other restrictions on Split Scrambling in this language, pro-drop and limits on intervening constituents. She concludes that the One-Split-per-Clause Constraint in Polish is a consequence of these two, and she regards them as

restrictions which facilitate processing. However, as was shown above, Russian Split Scrambling does not obey the pro-drop and intervening constituents constraints; thus, the One-Split-per-Clause Constraint needs to be explained in an alternative way. Ideally we would find an account which accommodates both the stronger limitation on Polish, and the weaker one on Russian.

Again, there are two hypotheses to pursue: the One-Split-per-Clause Constraint may be either a grammatical or a processing restriction. The processing explanation would be based on the assumption that split scrambling constructions are complex enough even with a single split, and so they would cause processing overload if there were more than one split per clause. Furthermore, if two filler-gap relations overlap, ambiguity resolves concerning how they are paired up. As noted in Section 5.4.2 above, double-filler gap dependencies in the same sentence are generally subject to restrictions which reduce ambiguity.

However, the One-Split-per-Clause Constraint does have a sufficient explanation within the grammar even if processing overload may somehow contribute some practical value to this constraint. I have assumed that F(ocus)P is unique, like other functional projections such as D or Agrs, Agro etc. If there is only one FP per clause, there can be only one phrase that can use its SPEC as the landing site, since two phrases cannot move into one SPEC position. Therefore, only one phrase can be split in a clause. (Note that this does not preclude XP-Scrambling from co-occurring in the same clause as Split Scrambling because XP-Scrambling can be IP- or VP-adjunction.) Alternatively, the prosodic correlates of Split Scrambling may be restricted. Double Split Scrambling would involve two [-SS] and two [+CS] features, and as noted above, multiple feature assignment might be marginal.

It cannot be decided a priori whether a constraint exists in the grammar or reflects a failure of processing (or possibly is both in the grammar and motivated by processing limitations). To assess this it is necessary to consider the merits of both approaches, and to see which offers the most economical or plausible explanation of the data. I consider the issue of processing complexity of split scrambling constructions in Russian in Chapter 7.

## 6.5 Summary of Chapter 6

Under the Double-Movement analysis of Split Scrambling in Russian, one subpart of the discontinuous constituent is located in SPEC, FP and the other one is right-adjoined to FP. Split Scrambling as a syntax-phonology interface phenomenon has been argued to be driven by Focus considerations along the lines of Reinhart (1995). This is captured by an extension of the Focus-based approach proposed for Russian XP-Scrambling in Chapter 3. Sentences with Split Scrambling are perceived by native speakers of Russian as having special Constituent Focus on one of the two subparts of the split XP. This Focus structure is established by discourse context and communicative intentions. On this basis, prosodic features [ $\pm$ SS] and [+CS] can be assigned to some constituents: the phrase assigned [+SS] will carry default sentential focus which can project up in the tree, the phrase assigned [-SS] will have to be removed via XP-Scrambling, so that it does not receive sentential Focus. Any phrase assigned [+CS] will carry Constituent Focus (the latter feature can coincide with the feature [ $\pm$ SS]). [+CS] can be assigned to a subpart of an XP assigned [-SS] and it can project up to include the entire XP. If [+CS] is not intended to project to the whole XP, Split Scrambling separates the two subparts of the XP by postposing one part of the other.

Focus structure of split scrambling constructions with obligatorily projected FP offers a plausible explanation for the Periphery Constraint and the One-Split-per-Clause Constraint. One subpart of the XP is in SPEC, FP and the other one is right-adjoined to FP which constitute the left and the right outermost edges of the clause; this explains the Periphery Constraint. Standard XP-Scrambling is not restricted with respect to how many phrases can be scrambled in one sentence; it must therefore be assumed that it is an adjunction process which can be iterated. In contrast, Split Scrambling allows only one discontinuous constituent per clause, and this will follow from the presence of a unique FP in the clause.

Alternatively, it is possible that both the periphery Constraint and the One-Split-per-Clause may be due to processing limitations which result from the processing complexity of split scrambling constructions. This is one of the issues investigated in Chapter 7.

**Chapter 7: Processing Properties of Split Scrambling**

|     |                                                                                 |     |
|-----|---------------------------------------------------------------------------------|-----|
| 7.1 | Introduction .....                                                              | 254 |
| 7.2 | Syntax and Processing of Russian Experimental Sentences with Split Scrambling . | 255 |
|     | 7.2.1 General Remarks .....                                                     | 255 |
|     | 7.2.2 Analysis of Experimental Sentences .....                                  | 258 |
| 7.3 | Experiment 3: Chunk-by-Chunk Self-Paced Reading .....                           | 267 |
| 7.4 | Experiment 4: Sentence Completion Study .....                                   | 280 |
| 7.5 | Informants' Comments .....                                                      | 294 |
| 7.6 | Summary of Chapter 7 .....                                                      | 296 |

## 7.1 Introduction

In Chapters 5 and 6 a grammatical account of Split Scrambling has been developed. However, the possibility arose that some of the characteristics of the split scrambling construction, and its variability across languages, might be attributed instead to the processing complexity of sentences in which argument phrases are broken up, and multiple chains must be computed. The general goal of this chapter is to investigate the processing characteristics of Split Scrambling constructions in Russian. In particular, it aims to provide answers to two questions. First, is there extra processing cost associated with Split Scrambling in comparison with XP-Scrambling? Second, is there evidence consistent with a processing source for the restrictions which Split Scrambling in Russian obeys. Experiments 1 and 2 from Chapter 4 have shown, for globally ambiguous sentences, that the unscrambled meaning is preferred when it is available, and that it takes longer to read scrambled sentences than their unscrambled counterparts. These results were interpreted as evidence in favor of the Scrambling Complexity hypothesis. If Split Scrambling is standard XP-Scrambling plus an additional movement (Extraction) operation, we may expect it to be even more costly in processing terms than XP-Scrambling. Two experiments were conducted in order to investigate the issue of complexity of Split Scrambling, and to see if processing data confirm the Periphery Constraint.

In Section 7.2 the syntactic analysis of experimental materials is presented. In addition, theoretical predictions are formulated about how such structures can be expected to be processed, assuming the Minimal Chain Principle (MCP) (De Vincenzi, 1991) and the Minimal Revision Principle (Ferreira and Fodor, in press) of the Garden-Path processing model.

Experiment 3 (Section 7.3) is an on-line study using a self-paced reading task. This task was chosen because it allows the tracking of processing load throughout the sentence. Garden-path effects will be reflected in the lengthening of reading times at specific points in a sentence. Experiment 4 (Section 7.4) is an off-line sentence completion study designed to test how split DPs

are processed and whether psycholinguistic evidence supports the Periphery Constraint. The sentence completion paradigm provides evidence of the parser's preferred analysis of an ambiguity in the sentence fragment presented to the subject. Like any production task, it also reveals what constructions are regarded as well-formed by naive subjects.

## 7.2 Syntax and Processing of Russian Experimental Sentences with Split Scrambling

### 7.2.1 General Remarks

The production study reported by Sirotinina (1965) showed an asymmetry in preferences for different split word orders. In 90% of DP cases (N=580) with a single modifying adjective, the adjective was preposed, and in only 10% of them was it postposed. Thus, the order N X Adj is quite rare. This pattern provides one of the reasons why sentences of the Adj X N type were chosen for the processing studies to be reported in Section 7.3 and 7.4. Since some of these sentences were temporarily ambiguous between Adj X and N X at the beginning, they could also shed some light on the processing of the N X Adj order, as will be explained below. A discussion of the general linguistic characteristics of the experimental sentences and predictions with respect to how they are processed is presented in this section.

The sentences that were tested in the experimental setting are illustrated in (1)-(4). Examples (1) and (3) represent Split Scrambling constructions, and examples (2) and (4) represent their corresponding length-matched constructions without Split Scrambling but with XP-Scrambling. (Here and below the length-matched phrases that are central to the experimental setup are in italics, and the subparts of a discontinuous phrase are underlined).

- |                                         |                            |                  |                                   |                           |                  |
|-----------------------------------------|----------------------------|------------------|-----------------------------------|---------------------------|------------------|
| (1)                                     | <i>Šumnuju</i><br>loud-ACC | kupili<br>bought | naši sosedi.<br>our neighbors-NOM | <i>sobaku.</i><br>dog-ACC | SPLIT SCRAMBLING |
| ‘Our neighbors bought the loud dog.’    |                            |                  |                                   |                           |                  |
| (2)                                     | <i>Sobaku</i><br>dog-ACC   | kupili<br>bought | naši sosedi<br>our neighbors-NOM  | <i>deševo.</i><br>cheaply | XP- SCRAMBLING   |
| ‘Our neighbors bought the dog cheaply.’ |                            |                  |                                   |                           |                  |

- (3) *O krasivoj* vspominal moj dvojurodnjy brat *studentke*. SPLIT SCRAMBLING  
of beautiful-PREP thought my cousin-NOM student-PREP  
‘My cousin thought of the beautiful student.’
- (4) *O studentke* vspominal moj dvojurodnjy brat *postojanno*. XP-SCRAMBLING  
of student-PREP thought my cousin-NOM constantly  
‘My cousin thought of the student constantly.’

The experimental sentences with PPs (3)-(4) are exactly like the sentences with DPs except that the scrambled object was part of a prepositional phrase. Except where stated otherwise, the discussion below applies equally to DP and PP examples.

Experimental sentences with XP-Scrambling, like (2) and (4), were examples of OVS word order. How frequent is this word order in Russian? Although comprehensive statistical data of the typical word orders in Russian is not available, there exist a few studies like the one conducted by Sirotinina on Russian nominals (see Section 6.2.1 above) and Bivon’s study on word orders reported by Bailyn (1995). Bailyn summarizes Bivon’s findings for statistical frequency of different orders in written Russian as in Table 18.<sup>1</sup>

Table 18. Percentage of Russian  
3-Member Sentence Types

| WORD ORDER | PERCENT |
|------------|---------|
| SVO        | 81%     |
| SOV        | 1%      |
| VSO        | 1%      |
| VOS        | 2%      |
| OSV        | 4%      |
| OVS        | 11%     |

(Bailyn, 1995: p.13)

SVO is as expected the most frequent word order, and Bivon’s empirical findings are supported both by the intuitions of native speakers and by theoretical and experimental work on Russian

<sup>1</sup> In a footnote Bailyn writes: “The percentages are based on an examination of the Essex Russian Language Project’s text”. However, he does not specify the number of the sentences in the text or the number examined on which these percentages are based.

(see Chapter 2 for discussion of the structure of the Russian clause). The second most frequent word order in the written language is OVS, accounting for 11% in Bivon's sample, which though quite low is more than all the remaining word orders taken together.<sup>2</sup> This fact allows us to assume that experimental sentences of the type illustrated in (2)-(4) are reasonably natural, and do not require special provisions to support acceptability.

Some experimental sentences were like (1)-(4) but, instead of a lexical subject, had a *pro* subject, as shown in (5), a counterpart to (2):<sup>3</sup>

- (5) *Plennogo*                      *priveli*    *na*    *očerednoj dopros*                      *zasvetlo*.  
 prisoner-ACC (N/Adj) brought for regular interrogation at dawn  
 'pro brought the prisoner for a regular interrogation at dawn.'

The difference between sentences with lexical subjects and those with *pro* subjects was not important for the purposes of Experiments 3 and 4. Therefore, I will treat (1)-(4) as generally representative of all experimental sentences.

The experimental sentences like (2) and (4), with XP-Scrambling, were all completed with an adverb. It was important to have all the sentences balanced in terms of the number of words in relevant frames, and in terms of their overall length. Therefore, to match sentences like (1) and (3) with Split Scrambling, which ended with the noun subpart of a discontinuous DP, an adverb was added to the sentences (2) and (4). In some instances, like sentences with VSAdv word order,<sup>4</sup> a final adverb can be marginal, but the experimental materials for Experiment 3 were all felicitous.

---

<sup>2</sup> Recent studies of Japanese show that Scrambling in this language is very rare: Yamashita (1996) gives a number of less than 1% for scrambled sentences in a transcription of informal discussions. It should be noted, however, that *pro*-drop (of either subject or object) is common in colloquial Japanese, and that since Japanese is verb-final, it is not possible to detect scrambling of one argument if the other is null.

<sup>3</sup> It is not completely clear what the structure is for the sentences like (5) with *pro* subject. Being an empty category, *pro* does not have to move (prohibition against vacuous movement), in which case the sentences with *pro* actually have a surface structure DP<sub>2</sub> *pro* V t<sub>2</sub>.

<sup>4</sup> Bailyn (1995) claims that sentences with the VSAdv order, where a post-verbal subject is followed by an adverb, are marked, as represented by the contrast in (i):

- (i) a. *Neožidanno priexal xozjain*.  
       unexpectedly arrived landlord-NOM

### 7.2.2 Analysis of Experimental Sentences

The surface structure of the experimental sentences (2) and (4) with XP-Scrambling is derived by scrambling the direct object *sobaku* 'dog-ACC' (*o studentke* 'of the student-PREP) into the left IP-adjoined position. An additional XP-Scrambling chain results from scrambling of the subject (Right Extraposition) and its VP-adjunction. This instance of XP-Scrambling will be ignored throughout the discussion that follows because all experimental sentences have post-verbal subjects. It is relevant, however, in that it potentially adds to the processing complexity of all the experimental sentences. Postverbal subjects were used in the materials so that the scrambled constituent on the left would be followed by a verb, which provides the clearest possible signal that Scrambling has occurred and that the end of the scrambled constituent has been reached. According to the theory of the structure of the Russian clause and the mechanism which derives XP-scrambling structure (as discussed in Chapter 2), the S-Structure for (2) is the following:

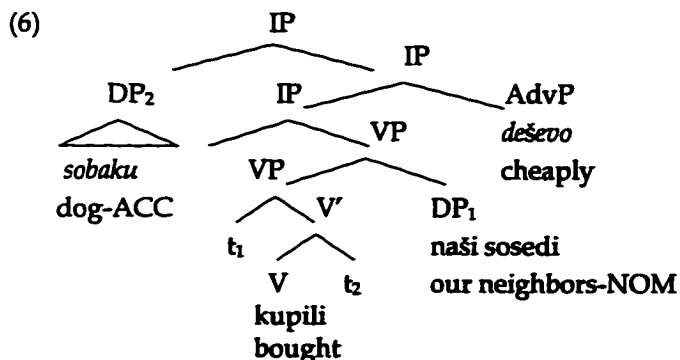

The S-Structure for example (4) with the scrambled PP is exactly the same as shown in (6), DP<sub>2</sub> being replaced by the PP *o studentke* 'of the student-PREP'.

---

b. ??Priexal xozjain neožidanno.  
 arrived landlord-NOM unexpectedly  
 'The landlord arrived unexpectedly.'

Bailyn finds such sentences infelicitous because they are zero-Theme sentences. (For an explanation of zero-Theme sentences see Chapter 3, Section 3.3). The experimental sentences were not zero-Theme.

In contrast to (2), example (1) is a split-scrambling construction with a discontinuous DP: the modifying adjective *šumnuju* 'loud-ACC' is separated from its noun *sobaku* 'dog-ACC' with which it constitutes a continuous direct object *šumnuju sobaku* 'loud dog-ACC' in the D-Structure. As is normally the case in Russian, this adjective agrees with its noun in all relevant morphological features (Case, gender, and number). Thus, the DP *šumnuju sobaku* carries the following morphological information: 'loud-ACC-F-SG dog-ACC-F-SG'<sup>5</sup>. *Šumnuju* 'loud-ACC' is also unambiguously an adjective; in order to be semantically interpreted and integrated into the sentence meaning, it has to modify a noun. Russian does not permit a null head to NP, as Chinese does, for example. Note the unacceptability of the incomplete sentence (7):

- (7) \**Šumnuju kupili naši sosedi.*  
 loud-ACC bought our neighbors-NOM  
 'Our neighbors bought the loud (?!).'

Following the Double-Movement analysis for split-scrambling constructions presented in Chapter 5, example (1) will be taken to have the following S-Structure. As was argued in Chapter 2, I will assume that the post-verbal subjects in Russian are XP-scrambled and adjoined to the right of VP (Right Extraposition); the lexical subject *naši sosedi* 'our neighbors-NOM' is right-adjoined to the VP. Then the direct object *šumnuju sobaku* 'loud-ACC dog-ACC' is XP-scrambled and is copied into SPEC, FP. A second movement operation extracts an N' and adjoins it to the right of FP, and only two subparts of the discontinuous DP appear in the surface structure, resulting in the representation (8):

---

<sup>5</sup> For simplicity in the discussion that follows, I omit gender and number features; the reader can assume that the elements of discontinuous constituents agreeing in Case also agree in these other morphological features.

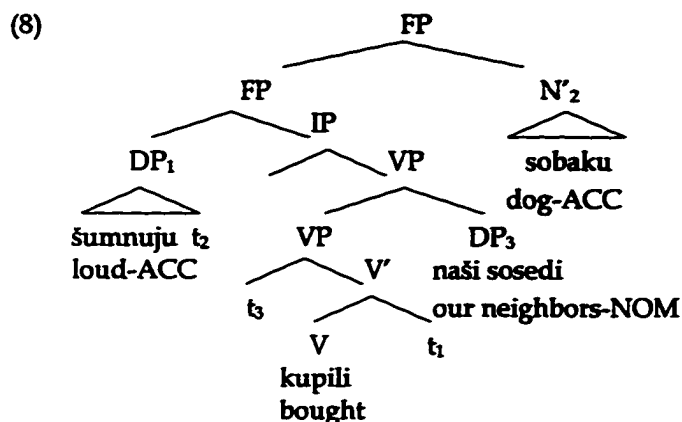

The same S-structure is derived for example (3), DP<sub>2</sub> being replaced by the PP *o krasivoj studentke* 'of the beautiful-PREP student-PREP'.

Assuming a full-attachment, serial parser as represented by the Garden-Path model of sentence processing (Inoue and Fodor, 1995; Clifton and Frazier, 1996, among others) as described in Chapter 4, how might the structures in (1) and (3) be processed? Recall that in the Garden-Path model, the parser is assumed to follow the strategy of *Minimal Everything*. That is, given two possible structures, one more complex than the other, the parser pursues the less complex one until there is evidence to the contrary. This model employs universal principles of structure building and ambiguity resolution: Minimal Attachment, Late Closure (Right Association), and the Minimal Chain Principle. The strategy of Minimal Everything applies equally to revision, which is reflected in the Minimal Revision principle. It has been argued in Chapter 4 that the MCP and Minimal Revision apply in the processing of standard XP-Scrambling constructions in Russian.

Let us briefly consider again how examples (2) and (4) with standard XP-Scrambling are processed, before investigating the additional complications that Split Scrambling brings into play. The parse proceeds from left to right in an incremental fashion. When the parser encounters the ACC-Case marked noun *sobaku* 'dog-ACC' at the beginning of the sentence in (6), it will project a DP. At this point the parser must create an IP node and adjoin this DP to the left

of IP because ACC Case-marking cannot be assigned to a subject in Russian.<sup>6</sup> Since this can only mean that this constituent has been scrambled from its D-Structure position, the second clause of the Minimal Chain Principle (MCP) (De Vincenzi, 1991) will force postulation of a scrambling chain. When the second word in the input is encountered, the verb *kupili* 'bought-PL', the partial phrase marker in (9a) is constructed:

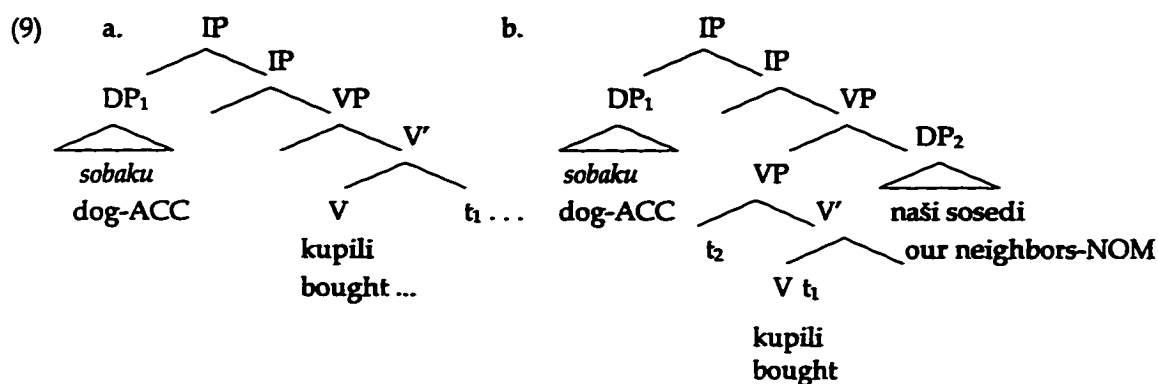

The last DP in the input, *naši sosedi* 'our neighbors-NOM', which arrives immediately after the verb, forces the parser to include it into (9b) as a post-verbal subject. As noted above, the structure in (9) contains at least one overt scrambling chain, which will produce some difficulty for the parser relative to sentences with no Scrambling. This difficulty, however, does not by itself cause processing overload, although it has been shown to result in longer reading times. The processing of example (3) will proceed in exactly the same manner, the only difference being that the scrambled phrase is the PP *o studentke* 'of the student-PREP'.

Consider now how example (1), the Split Scrambling counterpart of (2), is processed. The first constituent in the input is unambiguously an adjective. The parser will predict a structure where this adjective modifies a following head noun, and the NP is the complement within a DP, as shown in (10a). The ACC Case-marker will force the processor to construct this hypothetical

<sup>6</sup> As was discussed in Chapter 4, there is always an initial ambiguity in Russian sentences which do not begin with a NOM Case-marked DP because it is possible to hypothesize that there is a sentence-initial phonologically null subject pronoun. If later on a lexically filled NOM (or DAT) subject is encountered in the input, reanalysis occurs. This revision does not normally create a problem, so it is apparently more or less costless. The possibility that it added some slight difficulty to some of the experimental sentences cannot be ruled out, but in any case the sentences differed in various ways (e.g., lexically) and any consequences of this would be absorbed in the general 'noise' of the data.

DP as XP-scrambled and thus left-adjoined to IP. However, the second word in the input does not confirm this prediction because it is not a noun but a verb, *kupili* 'bought-PL'. Encountering a verb means that already at this point the parser has to change a previously built structure in order to reanalyze an XP-Scrambling chain into a Split Scrambling chain, as shown in (10b). This is in accordance with the Minimal Everything strategy that the parser is assumed to follow: a prediction of one scrambling chain would always be preferred to a prediction of two scrambling chains, until conflicting evidence forces the latter. The revision involves changing the higher IP node to FP, and positing an empty category inside the projected NP, in the head noun position.

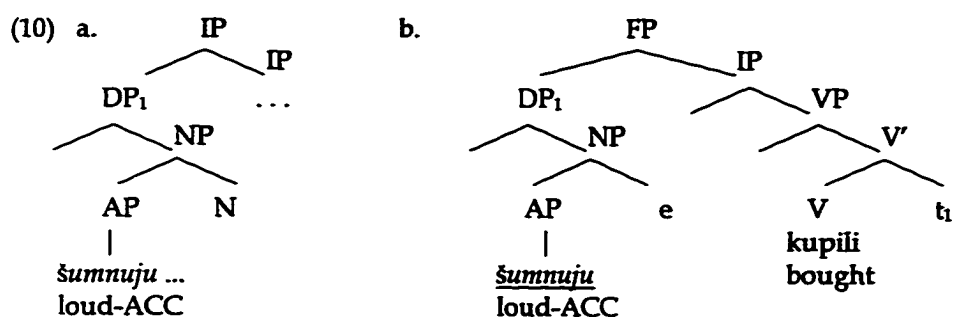

After reanalysis takes place, the parser would expect that what follows next in the input is the remainder of the VP, if any, and eventually the missing noun. In the case of (1), the next constituent in the input is the subject DP *naši sosedī* 'our neighbors-NOM', which is right-adjoined to the VP. It is processed exactly as in the XP-Scrambling example (2). Then the missing noun, *sobaku* 'dog-ACC' is encountered, which completes the split-scrambling chain. Since what follows is only the period, this satisfies the Periphery Constraint. The processing of example (4) with the split PP proceeds in a comparable manner.

In Experiment 2 (Chapter 4), it was found that the added cost of standard XP-Scrambling was reflected in a lengthening of reading times for whole sentences, as expected under the assumptions of the Garden-Path model: The presence of a scrambling chain contributes to the processing load for sentences with XP-Scrambling, relative to sentences with no Scrambling. We can expect that sentences with Split Scrambling will be processed at even greater cost than

sentences with XP-Scrambling because they are more complex, and because they require an additional reanalysis.

Whole sentence reading times could be used to assess processing load, as in Experiment 2. However, a more subtle experimental technique would be useful in exploring the processing of sentences with Split Scrambling, because the arguments about Split Scrambling specify particular points in the word string at which the reanalysis is initiated and an empty category within the leftward-scrambled phrase must be posited as the beginning of another chain. For the examples employed, this point in the input is the verb, which is encountered immediately after the sentence-initial adjective. If the parser expects a noun to immediately follow the adjective, to complete the DP, it will be surprised to encounter a verb instead, and will have to initiate reanalysis. This surprise and/or the work of reanalysis should be reflected in slower reading of the verb. An increase in verb reading time would thus constitute an initial evidence for a preference for XP-Scrambling constructions over Split Scrambling constructions.

The set of experimental sentences was further expanded to provide a contrast with respect to the category of the sentence-initial phrase, i.e., the scrambled direct object DP or verb complement PP. While the sentence-initial phrases in (1) and (2), *šumnuju* 'loud-ACC' and *sobaku* 'dog-ACC', are unambiguously an adjective and a noun respectively, the corresponding sentence-initial phrases in (11)-(12), *borziju* 'borzoi-ACC' and *znakomj* 'acquaintance-PREP', are categorically ambiguous. They can be interpreted as a noun, as in (12) and (14), or as an adjective, as in (11) and (13):

- |      |                                                                                              |                      |                                       |                                   |                  |
|------|----------------------------------------------------------------------------------------------|----------------------|---------------------------------------|-----------------------------------|------------------|
| (11) | <u>Borziju</u><br>borzoi-ACC<br>'Our neighbors bought the borzoi dog.'                       | kupili<br>bought     | naši sosedi<br>our neighbors-NOM      | <u>sobaku.</u><br>dog-ACC         | SPLIT SCRAMBLING |
| (12) | <i>Borziju</i><br>borzoi-ACC<br>'Our neighbors bought the borzoi cheaply.'                   | kupili<br>bought     | naši sosedi<br>our neighbors-NOM      | <i>deševo.</i><br>cheaply         | XP- SCRAMBLING   |
| (13) | <u>O znakomj</u><br>of acquaintance-PREP<br>'My cousin thought of the student acquaintance.' | vspominal<br>thought | moj dvojurodnyj brat<br>my cousin-NOM | <u>studentke.</u><br>student-PREP | SPLIT SCRAMBLING |

- (14) *O znakomoj vspominal moj dvojurodnyj brat postojanno.* XP-SCRAMBLING  
 of acquaintance-PREP thought my cousin-NOM constantly  
 'My cousin thought of the acquaintance constantly.'

With a noun interpretation, these phrases constitute well-formed DPs, as in (12) and (14). However, since they can also be used as adjectives, they can optionally be combined with a suitable noun, either immediately following, or delayed in a split scrambling construction, as in (11) and (13).

Morphologically, these categorically ambiguous words are adjectives, that is, they are marked with declension markers characteristic of adjectives; masculine endings are *-ij/-yj/-oj*, feminine *-jaja/-aja*, while the plural gender neutral markers are *-ie/-ye*.<sup>7</sup> The morphology of such words does not distinguish them from regular adjectives which always require a noun to complete the DP.<sup>8</sup> Nouns are derived from these adjectives by a derivational process called *nominalization* (in traditional Russian grammar this is known as *substantivacija* 'substantivization', and the nouns are called *substantivised* or *nominalized adjectives*). This phenomenon is not unique to Russian; categorical ambiguity of this type can be found in English, e.g., *The poor people received government assistance vs. The poor received government assistance*.<sup>9</sup>

Native intuitions show variability with respect to how naturally different adjectives can be nominalized. One group of adjectives allows nominalization so well that a noun interpretation is absolutely preferred; indeed, some of these have already shifted so much into the noun group that they can no longer be used to modify a noun, e.g., *vožatyj* 'camp counselor', *masterovoj*

<sup>7</sup> The morphological alternations within the set for a particular gender and number depend on the nature of the last stem consonant (palatalized vs. non-palatalized), and on the location of the stress.

<sup>8</sup> Some categorically ambiguous words are not adjectives but participles which are regarded as a separate part of speech in traditional Russian grammar. These are marked with participial suffixes which precede the declension marker, e.g., *-ann/-enn*: *soslannyj* 'in exile-PART'; *-ušč/-jušč*: *golodajuščie* 'starving-PART'. However, participles and adjectives in the sentences under consideration behave alike syntactically.

<sup>9</sup> It has sometimes been proposed that these adjectives (in English, and by extension also in Russian) are indeed in modifier position and are followed by a phonologically empty noun. However, the adjective/noun alternation is lexically restricted in both languages, which makes a lexical derivation of the noun more plausible than the null noun analysis.

'artisan'. Other examples are equally acceptable as nouns and adjectives, and preferences vacillate, e.g., *dežurnyj* 'on duty', *bezrobotnyj* 'unemployed'. Finally, some adjectives are such that although they allow nominalization, their preferred use is as adjectives, e.g., *torpednyj* 'related to torpedo', *živoj* 'alive'. The categorically ambiguous words that were included in Experiments 3 and 4 were from the second and third group only.

A clear prediction falling out of the assumption that, all being equal, the parser prefers less costly structures (Minimal Everything) is that subjects will avoid postulating discontinuous constituents whenever possible (specifically, Minimal Chains). Examples with categorically ambiguous words like those in (11)-(14) test this prediction since these can be interpreted as involving either complete or incomplete constituents. Note that, categorical ambiguity aside, these examples are entirely parallel to the unambiguous examples of (1)-(4).

Within the Garden-Path model, the processing of sentences with categorical ambiguity involves resolving this ambiguity right at the point where it arises or very soon thereafter (see Frazier and Rayner, 1987). Note that ambiguity in (11)-(14) is temporary and is resolved sentence-finally; in (11) and (13) a noun which has no other possible role in the sentence than as the head of the object NP forces an adjective interpretation of the ambiguous word; in (12) and (14) the absence of any such noun forces a noun interpretation. In this respect, sentences (11)-(14) differ from the sentences with XP-Scrambling used in Experiment 2. The latter were globally ambiguous, that is, they allowed two different syntactic interpretations (whether equally preferred, or one more preferred than the other) throughout the processing of the entire sentence.

Temporarily ambiguous sentences of the type (11)-(14) create a garden path if they continue in a way contrary to the preferred analysis of the ambiguous word. If the sentence-initial phrase were analyzed on-line as a complete constituent, i.e., as a DP, the categorically ambiguous word would be given a noun interpretation. The parser could posit XP-Scrambling only, rather than Split Scrambling, until an adjective interpretation is forced by the sentence-final noun of (11) and (13), cf. (12) and (14). This is in contrast to the obligatory adjective interpretation

of the unambiguous sentence-initial word in examples (1) and (3) in which, at the verb, the parser is struck with an unavoidable Split Scrambling analysis. In sentences with Split Scrambling like (11) and (13) there should be a processing cost early on, as the parser recognizes that Scrambling has occurred, but this is expected to be less severe than for examples (1) and (3), since only XP-Scrambling, not Split Scrambling, need be posited on-line for (11) and (13). The site where we would expect to see measurable garden path effects is at the sentence-final noun. If the sentence-initial ambiguous phrase is temporarily interpreted as an XP-scrambled noun, but the sentence-final element is also a noun with no other plausible role in the sentence, reanalysis is required. The lexical category of the first word, and its position within the DP, must be revised, and the indexed chain for the Split Scrambling analysis must be inserted. The prediction is then that there should be a detectable cost sentence-finally in (11) and (13) in comparison with sentences (12) and (14) which have an adverb completion that does not force reanalysis.

Note that the prediction of sentence-final reanalysis is contingent on the prediction of an initial misanalysis of the split-scrambling construction as an XP-scrambling construction. This has been assumed, in the discussion so far, to be the parser's preference, since it allows the simplest structure for the DP. However, to the extent that lexical selection precedes syntactic tree-building and is not influenced by it, it could be the case that the adjective meaning of the ambiguous word is preferred in some cases, despite the fact that it would entail a more complex tree structure once the verb has been encountered. Thus minimal tree-building is counterposed here to lexical preference.

In summary, in an experimental paradigm using the chunk-by-chunk self-paced reading technique which roughly imitates serial, incremental processing, we would expect to find evidence of a processing cost of split-scrambling constructions relative to XP-scrambling, at particular points in the sentence, namely, at the verb frame for categorically unambiguous cases (1) and (3), and at the sentence-final frame for categorically ambiguous cases (11) and (13). In the

next section I report the procedure and results of Experiment 3, a chunk-by-chunk self-paced reading study which put these predictions to the test.

### 7.3 Experiment 3: Chunk-by-Chunk Self-Paced Reading

Experiment 3 gathered reading time and probe decision data for Russian XP-Scrambling and Split Scrambling sentences presented on-line using a chunk-by-chunk self-paced reading technique.

#### Method

*Subjects.* Seventy-six volunteer subjects participated successfully in this experiment, 19 in each of the four versions of the experiment. All were undergraduate students at the Philological Department of Moscow State University and native speakers of Russian. Subjects were naive with the respect to the purpose of the experiment. Typically, subjects took 20-25 minutes to complete the experiment.

*Materials and Design.* Experimental sentences for the self-paced reading task were constructed in quadruples. Each such quadruple was generated around a basic sentence involving Split Scrambling of a direct object DP, as in (15), or Split Scrambling of a PP complement to the verb, as in (16). These basic sentences involved no categorical ambiguity:

- (15) Šumnuju kupili naši sosedi sobaku.  
 loud-ACC bought our neighbors-NOM dog-ACC  
 'Our neighbors bought the loud dog.'
- (16) O krasivoj vspominal moj dvojurodnjy brat studentke.  
 of beautiful-PREP<sup>10</sup> thought my cousin-NOM student-PREP  
 'My cousin thought of the beautiful student.'

As per the preceding discussion (see also Chapters 5 and 6), the landing sites for the subparts of the discontinuous constituents were peripheral in the sentence. The adjective, for discontinuous

---

<sup>10</sup> Prepositions in Russian vary in the case they assign to their noun complements. The prepositions used in the experimental sentences of the PP type were not controlled in terms of which case they assigned.

DPs, or the preposition-plus-adjective, for discontinuous PPs, was sentence-initial and followed by the verb, while the noun was sentence-final. The verb and the sentence-final noun were separated by a post-verbal subject or, for sentences with *pro* subject, by an adjunct PP. In the construction of all such sentences, care was taken to select modifying adjectives (e.g., *šumnuju* 'loud-ACC', *krasivoj* 'beautiful-PREP') which were lexically unambiguous. In normal usage, these could only be read adjectivally.

Such basic sentences, exhibiting Split Scrambling and no ambiguity in the category of the left split-scrambled adjective, provided the basis for the construction of quadruples in a design factorially combining Scrambling Type with Categorical Ambiguity. XP-scrambled counterparts of the original sentences placed their complete object DPs or PPs sentence-initially, omitting the modifying adjective, and had an added adverb, matched in length to the split-scrambled noun in (15) and (16), in place of that noun in sentence-final position, e.g., *deševo* 'cheaply', *postojanno* 'constantly'.<sup>11</sup> Counterparts of the resulting Split Scrambling/XP-Scrambling sentence pair, now incorporating categorical ambiguity, were constructed via the selection of lexical items having both adjectival and nominal meanings, e.g., *borzuju* 'borzoi-ACC', *o znakomoj* 'of acquaintance-PREP', as the first word in the sentence. In virtue of their ambiguity, such items could substitute both for the adjective of a split-scrambled sentence and for the noun of an XP-scrambled sentence.

Examples of the quadruples resulting from this construction process are illustrated in (17), for sentences of the DP type (repeated from (1)-(4)), and in (18) for sentences of the PP type (repeated from (11)-(14) above):

---

<sup>11</sup> Adverbs were not matched in frequency to the nouns they replaced, due to the lack of a reliable frequency dictionary for Russian.

|         | FRAME 1                                                                                                                            | FRAME 2              | FRAME 3                               | FRAME 4                               |                                                  |
|---------|------------------------------------------------------------------------------------------------------------------------------------|----------------------|---------------------------------------|---------------------------------------|--------------------------------------------------|
| (17) a. | <u>Šumnuju</u><br>loud-ACC<br>'Our neighbors bought the loud dog.'                                                                 | kupili<br>bought     | naši sosedi.<br>our neighbors-NOM     | <u>sobaku.</u><br>dog-ACC             | SPLIT SCRAMBLING,<br>NO CATEGORICAL<br>AMBIGUITY |
| b.      | <u>Sobaku</u><br>dog-ACC<br>'Our neighbors bought the dog cheaply.'                                                                | kupili<br>bought     | naši sosedi<br>our neighbors-NOM      | <u>deševo.</u><br>cheaply             | XP-SCRAMBLING,<br>NO CATEGORICAL<br>AMBIGUITY    |
| c.      | <u>Borzuju</u><br>borzoi-ACC<br>'Our neighbors bought the borzoi dog.'                                                             | kupili<br>bought     | naši sosedi<br>our neighbors-NOM      | <u>sobaku.</u><br>dog-ACC             | SPLIT SCRAMBLING,<br>CATEGORICAL<br>AMBIGUITY    |
| d.      | <u>Borzuju</u><br>borzoi-ACC<br>'Our neighbors bought the borzoi cheaply.'                                                         | kupili<br>bought     | naši sosedi<br>our neighbors-NOM      | <u>deševo.</u><br>cheaply             | XP-SCRAMBLING,<br>CATEGORICAL<br>AMBIGUITY       |
| (18) a. | <u>O krasivoj</u><br>of beautiful-PREP<br>'My cousin thought of the beautiful student.'                                            | vspominal<br>thought | moj dvojurodnyj brat<br>my cousin-NOM | <u>studentke.</u><br>student-<br>PREP | SPLIT SCRAMBLING,<br>NO CATEGORICAL<br>AMBIGUITY |
| b.      | <u>O studentke</u><br>of student-PREP<br>'My cousin thought of the student constantly.'                                            | vspominal<br>thought | moj dvojurodnyj brat<br>my cousin-NOM | <u>postojanno.</u><br>constantly      | XP-SCRAMBLING,<br>NO CATEGORICAL<br>AMBIGUITY    |
| c.      | <u>O znakomoj</u><br>of acquaintance-PREP<br>'My cousin thought of the student acquaintance.'<br>(Lit. 'the acquaintance student') | vspominal<br>thought | moj dvojurodnyj brat<br>my cousin-NOM | <u>studentke.</u><br>student-<br>PREP | SPLIT SCRAMBLING,<br>CATEGORICAL<br>AMBIGUITY    |
| d.      | <u>O znakomoj</u><br>of acquaintance-PREP<br>'My cousin thought of the acquaintance constantly.'                                   | vspominal<br>thought | moj dvojurodnyj brat<br>my cousin-NOM | <u>postojanno.</u><br>constantly      | XP-SCRAMBLING,<br>CATEGORICAL<br>AMBIGUITY       |

In total, 32 quadruples of the DP type were constructed, and 32 of the PP type, for a materials list of 256 experimental sentences in all. These sentences varied in length from five to seven words. Appendix 3 lists the experimental materials in full, along with their translations.

For presentation in the self-paced reading task, experimental sentences were divided into four frames. Frame 1 was just the split-scrambled remnant or XP-scrambled phrase, Frame 2 was the immediately following verb, Frame 3 was the post-verbal subject (or adjunct PP, for sentences

with *pro* subjects), and Frame 4 was the sentence-final word, i.e., the noun in the case of split scrambled sentences, or its length-matched adverb in the case of XP-scrambled sentences.

A probe word was selected for each experimental quadruple, to be displayed in a fifth frame immediately following the offset of a sentence. A "positive" probe was a word that had appeared in the sentence, and was displayed in exactly the form of its sentential usage, i.e., with the same morphological features such as case and number. A "negative" probe had not appeared in the sentence, but was selected to be a synonym or a close associate of some element in the sentence; again, the probe was appropriately morphologically marked. Since the same probe (either positive or negative) was to be used for all sentences within a quadruple, only the contents of Frames 2 and 3 which were constant across the quadruple were available for selection. Thus, for quadruple (17), a negative probe *DRUZ'JA* 'friends-NOM' was selected (cf. *sosedī* 'neighbors-NOM'), and for (18), a positive probe *DVOJURODNYJ* 'cousin-NOM'. The probes were nouns, adjectives, and verbs. They were equally balanced, in that half were negative and half positive, for experimental sentences of each of the DP and PP types.

In addition to the experimental sentences described above, 48 fillers were constructed. These included both unscrambled and XP-scrambled sentences, but no split-scrambled sentences. All fillers began with either a DP or a PP which consisted of a modifying adjective and a noun or a preposition plus a modifying adjective and a noun. This DP or PP was scrambled into sentence-initial position when it was an object or an adjunct; or it was the pre-verbal subject. The verb was always a single word, just as in the experimental sentences, and never a verb complex. The subjects were either lexical or *pro* subjects. Half of the fillers ended in an adverb, the remainder in a DP or PP. No words with categorical ambiguity were used in the fillers. In general, the fillers ranged in length between 5 and 8 words, on a par with experimental sentences.

The division of filler sentences into four frames for self-paced reading was designed to break up the necessarily rigid patterns of division in the experimental sentences. Frame 1 of a filler sentence always consisted of an adjective or preposition plus adjective. The contents of

Frames 2 and 3 varied, but in all cases Frame 2 began with the noun modified by the immediately preceding Frame 1 adjective; that is, while adjective and noun occurred in different frames these were immediately adjacent in the sentence. As noted, there were no discontinuous DPs or PPs in the fillers. The verb always began Frame 3 which also included other phrases, and Frame 4 completed the sentence, as shown in examples (19)-(21).

|      | FRAME 1                                                        | FRAME 2             | FRAME 3                                    | FRAME 4                     |               |
|------|----------------------------------------------------------------|---------------------|--------------------------------------------|-----------------------------|---------------|
| (19) | Otličnye<br>wonderful-ACC                                      | semena<br>seeds-ACC | zavezli na fermu<br>brought to farm        | so sklada<br>from warehouse | XP-SCRAMBLING |
|      | 'They brought wonderful seeds to the farm from the warehouse.' |                     |                                            |                             |               |
| (20) | O semejnoj<br>of family-PREP                                   | žizni<br>life-PREP  | vspominal on<br>thought he-NOM             | často.<br>often             | XP-SCRAMBLING |
|      | 'He often thought about his family life.'                      |                     |                                            |                             |               |
| (21) | Trenirovannye<br>athletic-NOM                                  | rebjata<br>guys-NOM | oxranjali dorogoj<br>guarded expensive-ACC | magazin.<br>store-ACC       | NO SCRAMBLING |
|      | 'Athletic guys were guarding an expensive store.'              |                     |                                            |                             |               |

As for the experimental sentences, post-sentential probes were constructed for each filler to be displayed in a fifth frame immediately following the offset of the sentence. Half the probes were positive, e.g., *VSPOMINAL* 'thought' in (20), *REBJATA* 'guys-NOM' in (21), and half were negative, e.g., *DOSTAVILI* 'delivered' (cf. *zavezli* 'brought') in (19).

Experimental and filler item lists (an item constituting a sentence plus an associated probe) were assembled to form an experiment in four versions. For the 256 experimental items (constructed in quadruples), materials were distributed over the four versions in a fully counterbalanced design, so that the 64 experimental items within any version made up 8 instances of each of 8 conditions (factorially combining Scrambling Type and Categorical Ambiguity, for each of the DP and PP sentence types), with no repetition of sentence content. Filler items were identical across versions. Thus, any one version of the experiment presented 112 sentence-plus-probe pairs in total, 64 experimental and 48 filler pairs. Seven additional practice items preceded the experiment proper.

*Procedure.* Subjects were tested individually, in a quiet location, with an experimental procedure which involved two tasks: Sentences were to be read in a self-paced fashion, and a decision was to be made about the probe word following each. Materials were presented on the liquid-crystal screen of a Sharp 486DX2-66 notebook computer, in a specially constructed Cyrillic font<sup>12</sup>, as white letters on a gray background. Each display frame was centered on the screen, immediately replacing the one preceding, under the control of DMASTR software (Forster and Forster, 1990).

Subjects initiated each item's presentation by pressing a footswitch. Sentences were displayed one frame at a time, the duration of each frame duration being response-contingent, i.e., the current frame was erased and immediately replaced by the next only when a response key was pressed. For the two-choice probe decision task which followed sentence reading, subjects indicated their decision by pressing one of two response keys labeled *ДА* ('Yes') and *НЕТ* ('No'). For the probe decision task (but not for self-paced reading), feedback was given to indicate whether the subject's response was correct or incorrect: *Правильно* ('Correct') and *Неправильно* ('Incorrect'). For correct responses, reaction time latencies were also provided, in milliseconds. When there was no response (in both self-paced reading and probe decision tasks), timeout occurred at 9 seconds.

At the beginning of the experimental session, subjects were instructed verbally about the tasks they were to perform. They would be reading sentences from Colloquial Russian which would appear on the screen in a chunk-by-chunk fashion, and after each frame was read (without sacrificing comprehension), they should press the 'Yes' button as fast as possible. When the probe appeared on the screen following the sentence, they should press the 'Yes' button if the probe had occurred in the sentence, and the 'No' button if it had not. Again, they were requested

---

<sup>12</sup> The display font differed from that used in Experiment 2 (Chapter 4), and was generally judged to be more easily readable. It was built by editing a stroked font originally designed for English (Triplex font, Borland software), adapting or adding characters as necessary for the orthography of Russian. This font has 'bookface' appearance and is proportionally spaced. In Experiment 4's displays, small letters were about a quarter of an inch high while the capital letters were about 3/8 of an inch. My special gratitude goes to Dianne Bradley for designing and adjusting this font.

to make probe decisions as quickly and as accurately as possible. These instructions were reinforced on the screen before the experiment itself began. Because of the feedback that appeared on the screen after each probe indicating whether the response had been correct, subjects believed that the probe decision task was the goal of the experiment. However, the probe decision task was included not as a source of data but only as a way to ensure that the sentences were being read at an appropriate level of comprehension. Both reading time and probe decision data were collected for experimental sentences.

*Data Treatment.* Ninety-two subjects in all participated in the experiment; of these, 16 were rejected because of poor performance characteristics. Eight subjects were rejected whose error rate in probe decision was 12.5% or higher, i.e., 8 out of 64 probes for the experimental sentences. One additional subject was rejected for unusually slow sentence reading times, i.e., mean reading time greater than 1250 msec. This was taken to indicate that the subject may have routinely stopped to think about the sentence, jeopardizing the on-line nature of the experiment. Finally, seven subjects whose mean reading time was unusually fast, i.e., less than 250 msec, were also rejected. Such subjects were taken to be performing purely rhythmically, so that their data were not likely to be sensitive to the content of what was being read.

The analysis that follows is based on the remaining 76 subjects. Subject-based analyses (collapsing over items) and item-based analyses (collapsing over subjects) were conducted on the self-paced reading time data, for sentences of the DP and PP types, separately. Within these two sentence types, data were analyzed separately for Frame 2 and Frame 4.

## **Results and Discussion**

Experiment 3 collected reading time data at two points, for experimental sentences: At Frame 2 in which the verb was displayed following a Case-marked DP or PP subpart (in split-scrambling constructions) or a Case-marked object (in XP-scrambling constructions); and at

Frame 4 in which a sentence-final object noun or adverb was presented (in split-scrambling and XP-scrambling constructions, respectively).

At Frame 2, the sentence types with categorically ambiguous contents in Frame 1 did not as yet differ from each other in content. The data analyses at Frame 2 therefore focused on the contrast of Scrambling Type only in sentences with unambiguous Frame 1 (see (17a,b) and (18a,b) above). In split-scrambling constructions, Frame 2's verb (*kupili* 'bought', *vspominal* 'thought') followed a lexical item selected to have only an adjectival meaning with or without a preceding preposition (*šumnuju* 'loud-ACC', *o krasivoj* 'of beautiful-PREP'), while in XP-scrambling constructions, these same verbs followed a noun or a preposition-plus-noun (*sobaku* 'dog-ACC', *o studentke* 'of student-PREP'). Table 19 below summarizes Frame 2 data, for each of the DP and PP sentence types.

**Table 19. Frame 2 Data: Mean Verb Reading Time (in msec) as a Function of Scrambling Type, for DP and PP Sentences with Categorically Unambiguous Frame 1**

| SCRAMBLING TYPE  | SENTENCE TYPE |              |
|------------------|---------------|--------------|
|                  | DP Sentences  | PP Sentences |
| Split Scrambling | 525           | 550          |
| XP-Scrambling    | 505           | 513          |
| Difference       | 20            | 37           |

It is evident from the data pattern in 19's data pattern that where the appearance of a verb signals a split-scrambling construction, reading times are longer than when the verb confirms the presumably preferred XP-scrambling construction. Data analysis showed the lengthening of reading times to be reliable; for DP sentences,  $F_1(1,72) = 6.36$ ,  $p < .025$ ,  $F_2(1,28) = 4.95$ ,  $p < .05$ ; and for PP sentences,  $F_1(1,72) = 22.51$ ,  $p < .001$ ,  $F_2(1,28) = 13.49$ ,  $p < .001$ . Note the difference in reading times is somewhat more robust for PP sentences (37 msec) than for DP sentences (20 msec). This might be interpreted as signalling greater difficulty of processing discontinuous PPs

than discontinuous DPs. However, this difference was not significant, an analysis across sentence types showing no reliable interaction,  $F_1(1,72) = 2.57, p > .10$ ,  $F_2(1,56) = 1.38, p > .10$ .

It was predicted (see Section 7.2) that sentences with Split Scrambling would take longer to process than sentences with XP-Scrambling, because the former are more complex (two scrambling chains) and require a reanalysis as soon as the verb is encountered (immediately after a sentence-initial adjective). And indeed, longer reading times were found at the verb frame for split-scrambling constructions. Apparently, the parser expected to complete the noun phrase, given an initial adjective or preposition-plus-adjective and was surprised to encounter a verb. This surprise and/or reanalysis, reflected in an inflated reading time on the verb, can be taken as evidence for a preference for structures without Split Scrambling. Thus, Split Scrambling is even harder than XP-Scrambling (which, in its turn, is harder than unscrambled sentences; see Chapter 4 for discussion).

At Frame 4, unlike Frame 2, the four sentence types (factorially combining Scrambling Type with Categorical Ambiguity) differ lexically from each other (see (17)-(18) above). It was necessarily the case, therefore, that Frame 4 comparisons could not be made over identical materials (as was the case at Frame 2). Instead, split-scrambling sentences have a noun at Frame 4 (*sobaku* 'dog-ACC', *studentke* 'student-PREP'), while XP-scrambling sentences have an adverb (*deševo* 'cheaply', *postojanno* 'constantly', respectively).

The data analyses at Frame 4 compare reading times for split-scrambled and XP-scrambled sentences, as a function of Frame 1's status with respect to categorical ambiguity. Recall that sentences beginning with an ambiguous phrase (*borzuju* 'borzoj-ACC', *znakomoj* 'acquaintance-PREP' in (17c,d) and (18c,d), respectively), whether split-scrambled or XP-scrambled, have exactly the same content throughout Frames 1, 2 and 3, and differ only at Frame 4. By hypothesis (and by the evidence presented above) the sentence-initial ambiguous phrase in such sentences will have been interpreted as an XP-scrambled noun, so that when the sentence-final element is also a noun, reanalysis is required. For sentences with a categorically ambiguous

element in Frame 1, it is the unexpected appearance of a noun, *sobaku* 'dog-ACC' or *studentke* 'student-PREP', that forces abandonment of the original XP-Scrambling analysis and adoption of a Split Scrambling analysis; the appearance of an adverb in the XP-Scrambling examples merely confirms the analysis already in hand. On the other hand, for sentences without categorical ambiguity in Frame 1, Split Scrambling and XP-Scrambling analyses are both already established and merely confirmed by Frame 4. Thus the crucial evidence for a special cost in processing split-scrambling sentences arises in the magnitude of the noun/adverb difference at Frame 4; that difference in reading times is expected to be greater in categorically ambiguous sentences (garden path) than in categorically unambiguous sentences (no garden path). The prediction is thus that there will be an *interaction* between Scrambling Type and Categorical Ambiguity, and in this interaction design, any influence of lexical differences is controlled out. Strictly speaking, the hypothesis that Split Scrambling takes longer to process than XP-Scrambling cannot be evaluated in the *direct* comparison of reading times for nouns and reading times for adverbs. For any number of reasons, the processing costs associated with nouns and adverbs in Russian might differ, intrinsically. In materials construction, the selection of length-matched noun/adverb pairs in common usage (though not frequency-matched) ensures only that lexical differences are likely to be minimal.

**Table 20. Frame 4 Data: Mean Noun/Adverb Reading Time (in msec) as a Function of Scrambling Type and Categorical Ambiguity, for DP Sentences (left panel) and PP Sentences (right panel)**

|                               | DP SENTENCES |             | PP SENTENCES |             |
|-------------------------------|--------------|-------------|--------------|-------------|
|                               | Ambiguous    | Unambiguous | Ambiguous    | Unambiguous |
| <b>SCRAMBLING TYPE</b>        |              |             |              |             |
| Split Scrambling <sup>a</sup> | 645          | 642         | 680          | 662         |
| XP-Scrambling <sup>b</sup>    | 631          | 629         | 639          | 639         |
| Difference                    | 14           | 13          | 41           | 23          |

<sup>a</sup> Frame 4 = Noun

<sup>b</sup> Frame 4 = Adverb

Although inspection of Table 20 suggests, for DP, that the sentence-final nouns in split-scrambling sentences might take longer to read than the adverbs in XP-scrambled sentences, there is no suggestion that the difference in reading time is greater when Frame 4 is the first signal of scrambling type (Categorically Ambiguous sentences) versus when it merely confirms what was established early in the sentence (Categorically Unambiguous sentences). The 14 msec difference for the former is statistically indistinguishable from the 13 msec difference for the latter. Overall, the difference in reading time was found to be not significant, that is, there was no main effect of Scrambling Type,  $F_1(1,72) = 3.44$ ,  $.05 < p < .10$ ,  $F_2(1,56) = 2.08$ ,  $p > .10$ . The crucial interaction of Scrambling Type and Categorical Ambiguity was not significant,  $F < 1$  for both subject- and item-based analysis. Apparently, there is no evidence of a garden path cost here.

For PP, inspection of Table 20 suggests that the situation might be different. The reading time differences for sentence-final nouns (split-scrambling sentences) versus sentence-final adverbs (XP-scrambling sentences) appear more substantial, roughly double the magnitude of the differences for DP. (Recall that the PP cases showed large magnitude effects at Frame 2, as well; see Table 19.) And there is at least a suggestion of the pattern predicted by the garden-path hypothesis: The noun/adverb difference is at least numerically larger for Ambiguous (41 msec) than for Unambiguous sentences (23 msec). The analyses showed that, overall, the noun/adverb difference was highly reliable,  $F_1(1,72) = 17.41$ ,  $p < .001$ ,  $F_2(1,56) = 10.44$ ,  $p < .01$ . But the interaction term of the analysis did not confirm the impression of greater lengthening in Ambiguous than Unambiguous sentences,  $F_1(1,72) = 1.40$ ,  $p > .10$ ,  $F_2 < 1$ . However, independent analyses comparing Split Scrambling and XP-Scrambling within each of the Ambiguous and Unambiguous types, separately, were suggestive. For Ambiguous cases, the 41 msec noun/adverb difference was reliable,  $F_1(1,72) = 12.57$ ,  $p < .001$ ,  $F_2(1,56) = 6.33$ ,  $p < .025$ , while for Unambiguous cases, the difference of 23 msec was reliable only in the subject-based analysis  $F_1(1,72) = 5.67$ ,  $p < .025$  but failed in the item-based analysis  $F_2(1,56) = 3.15$ ,  $.05 < p < .10$ . So, although the strongest evidence for a difference in patterning between Ambiguous and

Unambiguous cases was not found, there were some possible grounds for claiming support for a garden-path effect in the former.

### General Discussion

Overall, Experiment 3 produced mixed outcomes. There was evidence at Frame 2 for the Scrambling Complexity Hypothesis, in that it took subjects longer to read a verb after the sentence-initial unambiguous adjective. Effects were very strong for PPs and somewhat weaker for DPs. This lengthening of reading times suggests that reanalysis occurs after subjects initially hypothesized an XP-scrambled DP or PP, anticipating a noun to immediately follow the adjective. The necessity of reanalyzing this DP or PP as discontinuous, and of constructing a split-scrambling sentence instead, would impose an additional burden on the processor. However, the evidence for this at Frame 4 (in the contrast of sentences with categorically ambiguous/unambiguous adjectives) is at best equivocal. There is perhaps a suggestion of garden path effects for PPs, but no such effects were found for DPs. This situation parallels that at Frame 2, where the DP cases produce somewhat smaller effects than do the PP cases.

There are two questions that need to be asked with respect to the outcome of Experiment 3. First, why are the data clearer for the PP sentence types than for the DP? Second, why are garden-path effects weak at best, at Frame 4? Of course this might be because the linguistic analysis of Split Scrambling adopted here is incorrect, or because the Garden-Path model is false for Russian. But though these possibilities cannot be definitely ruled out without further research, it seems more likely that some methodological factors affected these results.

In terms of the lack of garden-path effects, it is possible that the self-paced reading technique as implemented in Experiment 3 was not sufficiently sensitive. Mitchell (1984) showed that, for English, the sensitivity of self-paced reading depends on the size of the fragment presented for reading: Chunk-by-chunk presentation was more sensitive than word-by-word. In Experiment 3, the crucial frames at which the reading times were recorded (Frames 2 and 4)

usually included just one word (sometimes they also included a particle), although Frame 3 always had two to three words. However, it should be borne in mind that Russian is unlike English in the sense that a typical Russian word is eight to ten characters and three to four syllables long. This makes it cumbersome to include many words in one frame, and it may also mitigate the disadvantage of one-word chunks noted by Mitchell. Another potential problem could be the “quality control” task. A probe decision task was used in Experiment 3 to ensure that subjects read sentences carefully, and certainly subjects believed that good performance in the experiment was achieved in accurate probe recognition. It is just possible that the probe task was too successful in directing subjects’ attention to the lexical forms used, with the consequence that higher-level sentential interpretations suffered. This problem could be avoided by the use of post-sentence comprehension questions instead.

Finally, there is one very important factor that needs to be taken into consideration in investigating the processing of Russian sentences, in general. Such processing may be highly dependent on morphological cues, since Russian is a morphologically rich language. For Split Scrambling, in particular, each subpart of a discontinuous constituent carries explicit morphological markers which possibly speed up the integration of phrases into the phrase marker. Thus, morphological cues may make garden-path effects so small that they become undetectable, unless very sensitive measures of processing load are employed.

In order to investigate possible sources of the differences between discontinuous PPs and DPs, Experiment 4 was designed. Its goal was to test in an off-line sentence completion study the DP sentences from Experiment 3 for which evidence about the costs of Split Scrambling was notably weaker than that for PPs.

## 7.4 Experiment 4: Sentence Completion

Experiment 4 gathered sentence completion data for sentence-initial fragments of three different lengths using exactly the same DP sentence types as in Experiment 3, the on-line self-paced reading study. The experimental fragments were short and medium length for Questionnaire A and long for Questionnaire B. The short sentence fragments in Questionnaire A established a baseline for the underlying lexical bias in the interpretation of the critical categorically ambiguous or unambiguous sentence-initial element. The medium sentence fragments in Questionnaire A included the verb that signalled a scrambling completion, and thus made it possible to assess how subjects responded to the syntactic pressure of a split-scrambling construction, and what ways they chose to avoid that construction when possible. The long sentence fragments in Questionnaire B included the initial scrambled item and the verb, as for the medium sentence fragments, but also the next constituent (i.e., Frame 3 in Experiment 3). This was designed to facilitate Split Scrambling by providing a context sufficiently long to clearly satisfy the Periphery Constraint (see Chapter 6).

### Method

*Subjects.* Two groups of subjects participated voluntarily in the experiment: 16 completed Questionnaire A, which presented Short and Medium fragments; a further 16 completed Questionnaire B, which presented Long fragments. All were students of Moscow Commerce University, and native speakers of Russian; none had participated in any of the other experiments reported here. Typically, subjects took 30 minutes to complete a questionnaire.

*Materials and Design.* Materials for the questionnaires were based on stimulus items used in Experiment 3, in particular, sentences of the DP type which made up the Split Scrambling conditions (ambiguous and unambiguous) of that experiment. It was important to test the DP cases because the outcome of Experiment 3 was inconclusive for them. PP fragments were also

included in the questionnaire, in exactly the same format and design; however, data for PP fragments have not yet been analyzed. The priority was set on those types for which the on-line data of Experiment 3 were weaker.

There were 32 pairs of such sentences, and sentences within a pair differed only in an initial critical element, either an unambiguous adjective (Adj), or a word ambiguous between noun and adjective meanings (N/Adj), always in the ACC case. Examples used to illustrate Experiment 3 (see (1) and (11) above, Section 7.2) are repeated here for convenience, // indicating the division into “frames” for Experiment’s 3 self-paced reading presentation:

- (1) Šumnuju // kupili // naši sosedi // sobaku.  
 loud-ACC bought our neighbors dog-ACC  
 ‘Our neighbors bought the loud dog.’
- (11) Borzuju // kupili // naši sosedi // sobaku.  
 borzoi-ACC bought our neighbors dog-ACC  
 ‘Our neighbors bought the borzoi dog.’

For the paper-and-pencil sentence completion study, Short fragment stimuli presented only the critical element of Frame 1; Medium fragment stimuli presented the contents of Frames 1 and 2; and Long fragment stimuli presented Frames 1, 2, and 3. Fragments were typed in standard Russian script (with no indications of frame divisions) followed by a dotted line. For example, from the full sentence shown in (11), fragments of three lengths were generated, and displayed in the questionnaire as follows:

- (22) a. Borzuju .....
- b. Borzuju kupili .....
- c. Borzuju kupili naši sosedi .....

Short fragments (22a) were intended to establish a baseline for the underlying lexical bias of N/Adj (in the case of ambiguous critical element, e.g., *borzuju* ‘borzoi-ACC’). In the case of an unambiguously adjectival critical element (e.g., *šumnuju* ‘loud-ACC’) the straightforward expectation will be that all interpretations would be adjectival. For ambiguous elements,

responses should reveal bias towards one category or the other when no syntactic pressure is being applied. Note that with Short fragments, subjects are not obliged to produce a split-scrambling construction in completing the sentence. With Medium fragments (22b), lexical bias may be overridden because an adjectival interpretation of the N/Adj ambiguity necessitates the construction of a sentence with a discontinuous constituent just as an unambiguous Adj does. Thus syntactic pressure is imposed on the lexical ambiguity. In designing Experiment 3, it was assumed that the syntactic pressure would win, but this is not self-evident and needs to be checked. It is important to test here whether there is a shift the pattern of lexical bias established with Short fragments, and also to see exactly how discontinuous constituents are handled when the adjective interpretation is taken. A noun must be supplied in the sentence completion. Is the noun always final? Or is the Periphery Constraint violated in order to fill the gap as soon as possible under the pressure from the MCP? Long fragments (22c) set up the same circumstances as do Medium, but offer a more extended context; however, the instructions given to subjects in the long fragment question (see below) meant that the Periphery Constraint was vacuously satisfied.

Questionnaire A presented subjects with both Short and Medium fragments. So that fully identical materials would not be presented twice to any subject, the questionnaire was constructed in two versions, the experimental materials being divided into two subsets for a counterbalanced design. Each version of the questionnaire presented half the materials as Short fragments (32 fragments, constructed as 16 ambiguous/unambiguous pairs), and the remaining half as Medium fragments, for a total of 64 experimental fragments for completion, in all. Fragment presentation was blocked by length, Short fragments being presented before Medium. Within either length condition, an Ambiguous fragment (e.g., *Borzuju*..... 'borzoi-ACC') always immediately preceded its Unambiguous counterpart (e.g., *Šumnuju*..... 'loud-ACC'). Subjects were instructed to complete each fragment in turn; however, the neighboring fragments were visible on the page as they worked. Subjects were also instructed that the fragments

belonged to spoken Colloquial Russian, and were asked to construct an appropriate mental context. The task was to complete the fragments so as to produce full grammatical sentences. No further restriction was placed on the content of sentence completions.

Questionnaire B presented only Long fragments, but (unlike Questionnaire A) used task instructions to restrict the content of subjects' completions in two different ways. For half the materials, subjects were instructed to complete the fragments with one word only (32 fragments, constructed as pairs); for the remaining half, the completion was to be achieved using one noun only.<sup>13</sup> Under either restriction, subjects were advised about the source of fragments (Colloquial Russian), about the usefulness of constructing an appropriate mental context, and about the general requirement that completed sentences be fully grammatical, as in Questionnaire A. In all other respects, the design of Questionnaire B followed that of Questionnaire A, with Task Instruction (in B) replacing Fragment Length (in A) as the basis for a counterbalancing over two versions. The questionnaire was blocked by Task Instruction, One Word instructions preceding One Noun instructions.

In sum, both questionnaires factorially combined Fragment Ambiguity (Ambiguous/Unambiguous initial critical element) with a second contrast, Fragment Length (Short/Medium) in the case of Questionnaire A and Task Instruction (One Word/One Noun) in the case of Questionnaire B. Appendix 4 presents both questionnaires in full.

*Data Treatment.* Subjects' sentence completion responses were first screened for grammaticality; responses which did not produce grammatical sentences were treated as missing data, as were outright failures to respond. Together, these occurred only rarely, constituting only 1.8% and 0.7% of responses to Questionnaires A and B, respectively. Crucially, violations of the Periphery Constraint were not counted as ungrammatical (see Table 21 below).

---

<sup>13</sup> One Noun instructions do not oblige the subject to construct a split-scrambling construction (though this might be more likely) because the noun supplied need not be a completion of the sentence-initial phrase, but could serve some other function such as subject (in sentences without lexical subject), locative or temporal modifier. Unlike all the other conditions in the experiment, however, Questionnaire B does effectively exclude completions that violate the One-Split-per-Clause Constraint.

The remaining responses were then categorized as either Adjective or Noun, reflecting the interpretation which the subject had evidently placed on the initial critical element of the fragment. Adjective interpretation was scored where a subject's response included a noun suitably case-marked to agree with the initial element; where no such noun was included, Noun interpretation was scored. The examples below illustrate typical Adjective-interpretation and Noun-interpretation responses, for Short, Medium, and Long fragments, respectively (*italics here and below represent subjects' actual completions*):

- (23) a. *Šumnuju kompaniju sobrali my na Novyj God.* ADJECTIVE INTERPRETATION  
 loud-ACC company-ACC gathered we-NOM at New Year  
 'We gathered a loud company at the New Year's party.'
- b. *Borzuju on kupil na vystavke sobak.* NOUN INTERPRETATION  
 borzoi-ACC he-NOM bought at show dogs-GEN  
 'He bought a borzoi dog at the dogs' show.'
- (24) a. *Šumnuju kupili my igrušku malyšu.* ADJECTIVE INTERPRETATION  
 loud-ACC bought we-NOM toy-ACC toddler-DAT  
 'We bought a loud toy for the toddler.'
- b. *Borzuju kupili oni dlja letnej oxoty.* NOUN INTERPRETATION  
 borzoi-ACC bought they-NOM for summer hunt  
 'They bought a borzoi for hunting in the summer.'
- (25) a. *Šumnuju kupili naši sosedi kofemolku.* ADJECTIVE INTERPRETATION  
 loud-ACC bought our neighbors-NOM coffee grinder-ACC  
 'Our neighbors bought a loud coffee grinder.'
- b. *Borzuju kupili naši sosedi včera.* NOUN INTERPRETATION  
 borzoi-ACC bought our neighbors-NOM yesterday  
 'Our neighbors bought a borzoi yesterday.'

For Medium and Long fragments, Adjective interpretations (ADJ) mean that the full sentence can be a split-scrambling construction, as shown in (24a) and (25a), and Noun interpretation (NOUN) mean that the full sentence is not a split-scrambled, but a standard XP-Scrambling construction, as in (24b) and (25b). Response categorizations were tallied over subjects for each item (in each condition of each version of each questionnaire), and the resulting frequencies,  $f$  (ADJ) and  $f$  (NOUN), used to calculate an item score:

$$\text{SCORE} = \frac{100 \times f(\text{ADJ})}{f(\text{ADJ}) + f(\text{NOUN})}$$

The score shows the percentage of sentence completion responses indicating adjective interpretation of the fragment's initial critical element.

These item-based scores were examined using analysis of variance. For Questionnaire A, the factors of interest were Fragment Length and Fragment Ambiguity; for Questionnaire B, they were Task Instruction and Fragment Ambiguity. For both questionnaires, both factors were treated as repeated measures.

Additionally, adjective interpretation responses to unambiguous fragments of Medium length were examined to determine the placements of the noun which was Case-marked to agree with the fragment's critical initial element. These responses were additionally coded as Periphery, Non-Periphery, or Periphery-By-Default. "Periphery" means that the Case-marked noun agreeing with the initial adjective was placed on the right periphery of the fragment, thus abiding by the Periphery Constraint, as shown in (26a). "Non-Periphery" means that the noun was placed elsewhere in the fragment (typically, immediately following the verb), as in (26b). "Periphery-By-Default" means that the fragment was completed with just one noun and nothing else, as in (26c). Although such responses do comply with the Periphery Constraint, it is not clear a priori whether these should count as positive evidence for that constraint in the way that responses like (26a) do:

- (26) a. Važnogo      priglasili *my* *včera*      gostja.      PERIPHERY  
 important-ACC invited we yesterday guest-ACC
- b. Važnogo      priglasili gostja      *my* *včera*.      NON-PERIPHERY  
 important-ACC invited guest-ACC we yesterday  
 'We invited an important guest yesterday.'
- c. Važnogo      priglasili gostja.      PERIPHERY-BY-DEFAULT  
 important-ACC invited guest-ACC  
 'pro invited an important guest.'

## Results and Discussion

For Questionnaire A, presenting Short and Medium length fragments for sentence completion, summary data are presented in Table 21 below:

**Table 21. Mean Percentage Adjective Interpretation, as a Function of Fragment Length and Ambiguity**

| FRAGMENT LENGTH | FRAGMENT AMBIGUITY |           |
|-----------------|--------------------|-----------|
|                 | Unambiguous        | Ambiguous |
| Short           | 87.5               | 32.0      |
| Medium          | 71.1               | 6.4       |

Medium: Adj Interpretation = Split Scrambling

Short: Adj Interpretation = XP-Scrambling or Split Scrambling

These data show, not surprisingly, that the rate of Adjective interpretations differs substantially when fragments began with a lexically ambiguous element and when they began with an element lexically specified as an adjective. More interestingly, the rate of Adjective interpretations drops, when it was a medium length fragment which was to be completed; in that case, an Adjective interpretation would commit a subject to constructing a sentence containing a discontinuous constituent. The most striking aspect of the data in Table 21 is that ambiguity and length act *additively*. That is, the syntactic pressure which the Medium length fragment brings to bear applies with equal force to ambiguous and (supposedly) unambiguous fragments. The analysis of variance supports these observations, and showed only main effects of Ambiguity,  $F_2(1,30) = 173.05$ ,  $p < .0001$ , and Length,  $F_2(1,30) = 49.68$ ,  $p < .0001$ ; there was no reliable interaction of these factors,  $F_2(1,30) = 2.22$ ,  $p > .10$ .

Short fragments serve as a baseline for Medium, because all the subjects saw in the former was the critical element itself. Although its ACC Case signaled a scrambled word order, subjects otherwise could complete these sentence fragments in any way they liked. Thus, any purely lexical biases would be revealed. Both Noun and Adjective interpretation options are still in principle available in the same lexically biased proportions for the ambiguous N/Adj critical

elements in Medium fragments, but the rate of Adjective interpretation rate nevertheless dropped markedly from that seen in Short fragments completions. Consider (27), for example:

- (27) a. Borziju 'borzoi-ACC' (37.5% Adj preference) SHORT  
 Borziju *sobaku on polučil v podarok ot otca.*  
 borzoi-ACC dog-ACC he-NOM received as gift from father  
 'He received a borzoi dog from his father as a gift.'
- b. Borziju 'borzoi-ACC' (0% Adj preference) MEDIUM  
 Borziju *kupili oni dlja letnej oxoty.*  
 borzoi-ACC bought they-NOM for summer hunting  
 'They bought a borzoi for hunting in the summer.'

The pattern illustrated in (27a, b) is typical of the overall (presented item by item in Table D, Appendix 4). The decline in the rate of Adjective interpretations It presumably arises under pressure of avoiding Split Scrambling. Taken as Noun, the critical element is merely XP-scrambled; taken as Adjective, the production of a discontinuous DP is forced for Medium fragments (but not for Short fragments). And it is easy to avoid Split Scrambling in examples like (27b) because the Noun interpretation can be chosen, even for lexical forms for which it is otherwise dispreferred.

For the supposedly unambiguous Adjective critical elements in Short fragments, we find that 13 fragments out of the total of 32 received a (lexically) unexpected Noun interpretation at least once<sup>14</sup>. Thus these items were not quite as unambiguous as they were intended to be. Here too, in medium fragment completions, the Adjective interpretation rate also dropped:

- (28) a. Tancujuščego 'dancing-N/Adj-ACC' (87.5% Adj preference) SHORT  
 Tancujuščego *pingvina ty videl kogda-nibud'?*  
 dancing-ACC penguin-ACC you-NOM saw ever  
 'Have you even seen a dancing penguin?'
- b. Tancujuščego 'dancing-N/Adj-ACC' (28.6% Adj preference) MEDIUM  
 Tancujuščego *razgljadyvala publika udivlenno.*  
 dancing-ACC was staring audience-NOM in surprise  
 'The audience was staring at the dancing [man] in surprise.'

<sup>14</sup> Two items tended to be dispreferred in adjectival usage even in completions of Short fragments; their Adjective interpretation rate fell below 50% (*lezačego* 'bed-ridden', and *usedšego* 'gone').

Exactly as with the ambiguous cases above, we can attribute the lower rate of Adjective interpretation to an attempt to avoid Split Scrambling. However, Noun interpretation is not easily available here, and often requires novel nominalizations resulting in doubtful sentence acceptability, as the contrast in (29) illustrates. In fact, (29b) sounds as bad as the English translation:

- (29) a. Novyx 'new-Adj-ACC' (100% Adj preference) SHORT  
 Novyx *russskix* *legko uznat'* *po dorogoj odežde.*  
 new-ACC Russians-ACC easy to recognize because of expensive clothes  
 'New Russians are easy to recognize because of their expensive clothes.'
- b. Novyx 'new-Adj-ACC' (37.5% Adj preference) MEDIUM  
 ?Novyx *otpravili na dal'nij učastok.*  
 new-ACC sent to remote site  
 \*'pro sent new to a remote site.'

It seems reasonable to suppose that Split Scrambling carries an additional load for the processor, so that when a choice is to be made between a discontinuous constituent and a novel nominalization, subjects choose the latter as an option which though perhaps grammatically dubious, requires less processing effort.

In order to test the hypothesis that subjects would obey the Periphery Constraint when there is flexibility in how to complete a Split Scrambling fragment, an additional analysis was conducted for the Medium fragment data from Questionnaire A. Out of 256 data responses to Medium fragments with unambiguous critical elements (16 subjects x 16 items per subject), 182 were completed with Split Scrambling (71.1%, see Table 20). For these 182 responses, the location of the noun completing the discontinuous constituent was established, as described above. Summary data are presented in Table 22:

**Table 22. Percentage Noun Location in the Medium Unambiguous Fragments**

| NOUN LOCATION        |      |
|----------------------|------|
| Periphery            | 19.8 |
| Non-Periphery        | 65.9 |
| Periphery-By-Default | 14.3 |

These data show that the subjects did not always, or even usually, obey the Periphery Constraint in constructing their fragment completions, and instead chose to “fill the gap” as soon as possible.<sup>15</sup> Thus, it appears that the sentence processing evidence not only fails to support the proposed Periphery Constraint, but positively speaks against it.

However, this is of interest because it makes fairly clear that the Periphery Constraint does not exist in order to make processing easier. To the extent that it holds, this constraint must have its origin in syntactic or Focus/discourse principles. At the same time, the outcome of Experiment 4 does not disconfirm the validity of the Periphery Constraint, though at first it may seem so. Rather, the likely involvement of the MCP in processing these constructions leaves open the possibility that the Periphery Constraint is sound, but is outweighed on-line by the MCP. (The MCP, of course, is assumed to be a processing constraint, though a very similar grammatical constraint has been proposed by Chomsky, 1993.)

For Questionnaire B, presenting Long fragments with two kinds of Task Instruction (One Noun vs. One Word) for sentence completion, summary data are presented in Table 23 below:

**Table 23. Mean Percentage Adjective Interpretation, as a Function of Task Instruction and Ambiguity**

|                     | FRAGMENT AMBIGUITY |           |
|---------------------|--------------------|-----------|
|                     | Unambiguous        | Ambiguous |
| TASK<br>INSTRUCTION |                    |           |
| One Noun            | 88.0               | 27.7      |
| One Word            | 73.9               | 12.9      |

Adj Interpretation = Split Scrambling

<sup>15</sup> Note that even if all the responses conservatively classified as Periphery-By-Default (i.e., single word completions) are grouped together with Periphery responses, the occasions on which the Periphery Constraint is obeyed are outweighed 2 : 1 by violations of the constraint.

The data pattern for Long fragment completion is in very many ways like that seen in Table 21 earlier, for Short and Medium fragment completions in Questionnaire A. As before, the rate of Adjective interpretations differed substantially when fragments began with a lexically ambiguous element and when they began with an element lexically specified as Adjective; for the main effect of Ambiguity,  $F_2(1, 30) = 262.66$ ,  $p < .0001$ . The rate of Adjective interpretation dropped for the main effect of Task Instruction,  $F_2(1, 30) = 50.06$ ,  $p < .001$ . When subjects were instructed to add a noun, they produced a noun which was Case-marked to agree with the fragment's initial element more often than when instructions were less specific. In the latter case, even when the fragment was unambiguously adjectival, discontinuous constituents were avoided 26% of the time. Note also that the most striking aspect of the data for Short and Medium fragments was reproduced in this very different situation: Ambiguity and task instruction acted additively, so that the decline in Adjective interpretations was the same, whether Noun interpretation is lexically licensed (Ambiguous fragments) or not (Unambiguous fragments). The analysis of variance showed no interaction of Ambiguity and Task Instruction,  $F_2 < 1$ .

In Questionnaire B, subjects were restricted in their options for completing the fragments grammatically, both by the task instructions and by the nature of the fragments. Unlike the Short fragments in Questionnaire A (but like the Medium fragments), grammatical completions could not be satisfied by the easy means of creating a continuous N Adj noun phrase; nonetheless, the processing pressure to avoid discontinuous constituents remains. It is not surprising, then, that Adjective interpretations were much fewer when the critical element was categorically ambiguous, but it is evident that One Noun instructions made this device for avoiding Split Scrambling less available. The completion responses shown in (30) are illustrative:

- (30) a. *Arestovannogo* 'arrested-N/Adj-ACC' (62.5% Adj preference) ONE NOUN  
*Arestovannogo* *privezli* *v* *Butyrskuju* *tjur'* *mu* *ministra*.  
 arrested-ACC brought to Butyrskaja jail minister-ACC  
 'They brought the arrested minister to Butyrskaja jail.'

- b. **Arestovannogo** 'arrested-N/Adj-ACC' (12.5% Adj preference) ONE WORD  
**Arestovannogo** privezli v Butyrskuju tjur'mu *nemedlenno*.  
 arrested-ACC brought to Butyrskaja jail immediately  
 'They immediately brought the convict to Butyrskaja jail.'

The impact of task instructions was also evident when the critical element was unambiguous. With One Noun instructions, the Adjective preference was very high but this dropped with One Word instructions. Since, in these unambiguous cases, a Noun interpretation of the critical element is (generally) ungrammatical, subjects again resorted to novel nominalizations. The examples in (31) are illustrative, where (31b) is as bad as its English equivalent:

- (31) a. **Izvestnogo** 'well-known-Adj-ACC' (100% Adj preference) ONE NOUN  
Izvestnogo privezli v Butyrskuju tjur'mu *politika*.  
 well-known-ACC brought to Butyrskaja jail politician.  
 'They brought the well-known politician to Butyrskaja jail.'
- b. **Izvestnogo** 'well-known-Adj-ACC' (87.5% Adj preference) ONE WORD  
 ?Izvestnogo privezli v Butyrskuju tjur'mu pod konvoem.  
 well-known-ACC brought to Butyrskaja jail under escort  
 \*'They brought the well-known to Butyrskaja jail under escort.'

Figure 1 below presents the data obtained in the two questionnaires, all together, to support a comparison of the patterns of outcome for Questionnaire A (Short and Medium fragments) with those for Questionnaire B (Long fragments, One Noun and One Word instructions). The figure makes it clear that these are striking parallel in these outcomes.

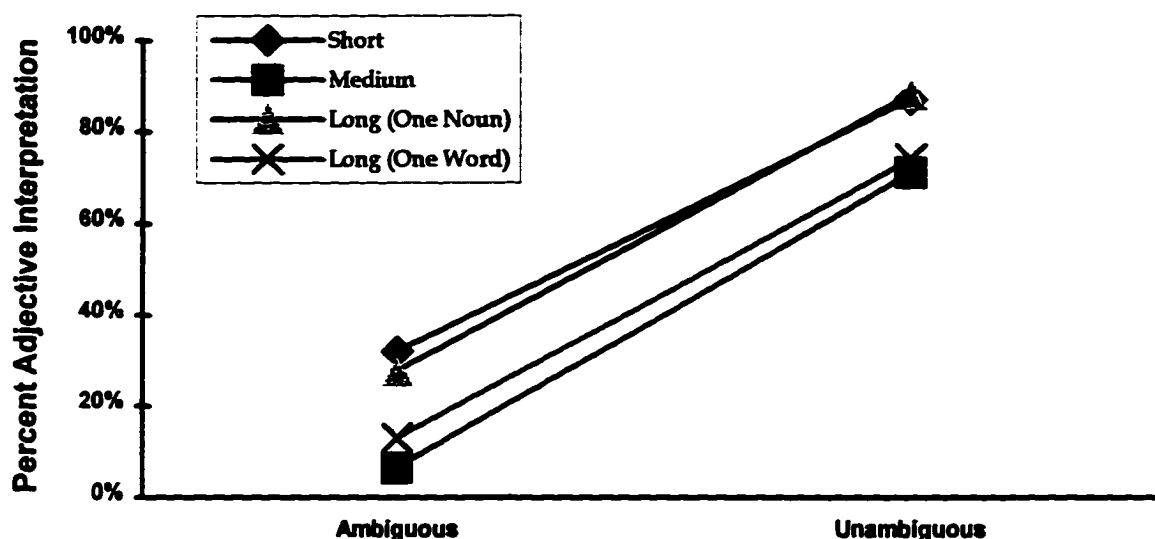

Figure 1. Comparison of data from Questionnaires A and B

As discussed earlier, the demands imposed on the parser differ (by hypothesis) with different interpretations of the critical element in Medium and Long fragments, but not in Short fragments. For Medium and Long fragments, a Split Scrambling construction is the inevitable consequence of an Adjective interpretation (cf. XP-Scrambling, with Noun interpretation), only an XP-Scrambling construction is necessitated with either interpretation. Thus the data from Short fragments provide baseline information about the lexical bias associated with the materials employed in the experiment. The data for Medium fragments and for Long fragments completed with One Word instructions provide direct evidence that Split Scrambling imposes a processing load greater than that imposed by XP-Scrambling: Whether the critical element is ambiguous (so that its interpretation as a noun is lexically licensed) or unambiguous (so that a novel nominalization must be invoked) the rate of Adjective interpretation drops.<sup>16</sup> It is not clear what account should be given for the fact that the drop in Adjective interpretation is uniform across ambiguous and unambiguous fragments. In the end, something as uninteresting as a floor effect

<sup>16</sup> An analysis of variance across questionnaires showed that there was a slightly lower rate of Adjective interpretation with Medium fragments than with Long fragments completed under One Word instructions,  $F_2(1, 30) = 6.24, p < .025$ . That is, most Split Scrambling constructions were produced when the Periphery Constraint was vacuously satisfied. However, it must be noted that this item-based analysis does not guarantee generalization over subject populations.

may have limited the extent of that drop for ambiguous fragments (recall that intrinsic lexical preferences in this materials set give only 32% Adjective interpretation, as estimated from the data for fragment completions), while the marginal grammaticality of the novel nominalizations through which Split Scrambling was avoided in unambiguous fragments undoubtedly acted as a natural brake. It may be entirely coincidental that these two very limiting mechanisms were equivalent in their impact; however, the very fact that Split Scrambling was avoided at all in completions of unambiguous fragments speaks to the additional burden which it imposes relative to XP-Scrambling.

Figure 1 also reveals that the rates of Adjective interpretation did not differ between Short fragments and Long fragments with One Noun task instructions. An analysis of variance across questionnaires showed no Questionnaire main effect, nor a Questionnaire X Ambiguity interaction,  $F < 1$  for both terms. Thus Split Scrambling constructions were produced for these Long fragments in exactly the proportions predicted by lexical preferences, the latter estimated in circumstances in which only XP-Scrambling is inevitable. Note that One noun instructions do not oblige subjects to construct a split scrambling construction, i.e., that noun need not be a completion of the ambiguous sentence-initial phrase. The noun produced in the sentence completion can serve other function: It can be a locative, or a temporal expression, since Russian allows such noun usage. The conclusion must be that the normal pressure applied by the extra processing costs of Split Scrambling, relative to XP-Scrambling (see above) can be nullified by task instructions.

Summarizing, the comparison of questionnaires shows that Split Scrambling can be imposed on subjects (as was the case with Long fragments, One Noun instructions), and that they can use this type of construction consistently to produce grammatical completions. However, when it is not required by task, they prefer to avoid Split Scrambling, as predicted by the Scrambling Complexity Hypothesis.

## General Discussion

Overall, the findings of Experiment 4 show that, in an off-line study, discontinuous DPs produce results consistent with the Scrambling Complexity Hypothesis. Subjects can, when necessary, create Split Scrambling constructions. However, whenever possible, subjects prefer to avoid using constructions with split DPs. They can do so easily when the critical element is ambiguous, simply by choosing a Noun interpretation. But the pressure to avoid creating discontinuous constituents is apparently strong enough that even in the case of the supposedly unambiguous Adj critical elements, subjects often find other ways to complete such sentence fragments, like resorting to novel nominalizations. The natural conclusion is that Split Scrambling imposes an unwanted, though not quite intolerable, burden on the human sentence processor.

Experiment 4 was also designed to check the validity of the Periphery Constraint, and to seek signs that it might result from a preference on the part of the processor. However, the results obtained for the Unambiguous Medium Length fragments indicate that the subjects strongly prefer to put in the missing noun as soon as possible, i.e., immediately after the verb, in violation of the Periphery Constraint. It seems very likely that this preference is due to the Minimal Chain Principle, which favors short chains, a tendency which may even be exaggerated in the context of a difficult construction such as Split Scrambling. The MCP and the Periphery Constraint are opposed here, and clearly the Periphery Constraint loses most of the time.

### 7.5. Informants' Comments

A note is due on subjects' reaction to the questionnaires in Experiment 4. After each questionnaire some space was provided to accommodate those who felt like commenting on the Split Scrambling structures which were the focus of Experiment 4. Among the 32 subjects who

participated in the two questionnaires of Experiment 4, 13 used the opportunity to provide the experimenter with their feedback. Typical comments were as follows:

- (4) (a) "Some of the examples are not very natural" (this comment, like most of those to follow, seemed to refer specifically to the unambiguous adjective cases which required Split Scrambling in order to make them grammatical);
- (b) "It is hard for me to complete these sentences because in my opinion they do not sound like proper Russian" or even "they do not sound like proper Colloquial Russian";
- (c) "Some of the sentences cannot be used in the language because they have illegal word order"; "Some examples are not characteristic of the Russian language";
- (d) "I do not consider some of these sentence fragments to be 'acceptable' sentence fragments";
- (e) "I can complete these sentence fragments only if I modify them" (the subject accepts standard word order as the only acceptable way of completing such fragments, and since Split Scrambling does not produce standard word order, its use means modification and not completion);
- (f) "Some of the sentences require only noun interpretation, i.e., the adjectives are nominalized";
- (g) "Some of the sentences can be finished in two opposite ways: the word can be interpreted as a noun or as an adjective. I could have completed all such sentences in either way depending on the context. Possibly, the verb has something to do with it";
- (h) "I find the sentences of the type AdjVSO only marginally acceptable because they require the noun at the end of the sentence, this makes them cumbersome and therefore hardly frequent in speech. I would say they characterize the genre of TV shows"; "Some sentences are possible only when the adjective is contrastively stressed".

This suggests, somewhat disturbingly, that for these native speakers Split Scrambling is not acceptable at all. However, there is good reason to doubt this. While in Moscow I listened carefully for natural occurrences of sentences with Split Scrambling. As I discovered, they are rather frequent in the speech of many people. However, when confronted and asked to repeat what they had just said, speakers would often repeat the sentence in its unscrambled variant, and deny having said it with a discontinuous phrase. The problem is certainly not a new one. It has been noticed before that there are striking discrepancies between subjects' acceptability judgments and their speech production. In the case of the Russian subjects who participated in Experiment 3 and 4, we are dealing with young people recently out of high school who have been

exposed to orthodox teaching for 11 years of their lives. This is exactly the case about which Siewierska wrote with respect to her Polish speakers:

“The predominantly prescriptive attitude to language ingrained by the Polish educational system induces speakers to provide judgments reflecting traditional teaching rather than actual usage.”  
(Siewierska, 1984: p.61)

This is exactly the situation with Russian subjects. Therefore, their comments should be taken with a grain of salt. Meanwhile we must keep looking for appropriate experimental tasks which would control for the possible distorting factors that may influence subjects' judgments, on the one hand, and subjects' performance, on the other.

## 7.6 Summary of Chapter 7

This chapter investigated the processing characteristics of Split Scrambling in Russian. Two experiments have been conducted to explore the Scrambling Complexity Hypothesis and the Periphery Constraint.

Experiment 3, an on-line chunk-by-chunk self-paced reading study, tested sentences with discontinuous DPs and PPs with unambiguous Adj and ambiguous N/Adj critical elements. Sentences involved either XP-Scrambling or Split Scrambling. The results of Experiment 3 showed that for both split DPs and PPs there was a lengthening of reading times on the verb, indicating a cost associated with reanalysis from an XP-Scrambling analysis to a split scrambling analysis. This was crucially important since the necessity for reanalysis was signalled early (at the verb) only if XP-Scrambling is assumed to be the preferred structure. However, the predicted garden path effect on the sentence-final noun, which was intended to force a late reanalysis (again, from an initial XP-Scrambling analysis to Split Scrambling) was evident only for discontinuous PPs – and even then, the data were less compelling than had been predicted. In general, Experiment 3 detected processing costs which could be taken as further evidence for the

**Scrambling Complexity Hypothesis: XP-Scrambling is harder to process than no Scrambling, and Split Scrambling in turn is harder to process than XP-Scrambling.**

Experiment 4, an off-line sentence completion study, was designed to investigate further the properties of the discontinuous DPs for which the results of Experiment 3 were mixed, and to look for psycholinguistic evidence for the Periphery Constraint. The experiment found a clear preference to avoid discontinuous DPs, even by using such dubious grammatical means as novel nominalizations. This is further support for the Scrambling Complexity Hypothesis.

While Experiment 4 clearly supported the Scrambling Complexity Hypothesis, it failed to confirm the Periphery Constraint. Presented with a context where they could either in order to obey the Periphery Constraint (and hold the gap unfilled) or where they could fill a gap as soon as ( but violate the constraint), subjects chose the latter solution. In fact, the experimental outcome not only fails to support the Periphery Constraint but even explicitly supports its overriding under processing pressure. While it is possible that a subtler experimental technique would produce more encouraging findings, further research is necessary to investigate the relationship between grammar and processor and its implications for the Periphery Constraint.

## APPENDICES

## APPENDIX 1: Experimental Materials for Experiment 1 (Chapter 4)

## THE NOM/ACC AMBIGUITY

1. a) Лирика увлекла *физика*.  
 b) Лирика *физика* увлекла.  
 c) *Физика* лирика увлекла.

READING 1: 'The lyrics attracted the physicist.'

READING 2: 'The physics attracted the romanticist.'

2. a) День сменяет *ночь*.  
 b) День *ночь* сменяет.  
 c) *Ночь* день сменяет.

READING 1: 'The day replaces the night.'

READING 2: 'The night replaces the day.'

3. a) Звук выстрела заглушил *рёв*.  
 b) Звук выстрела *рёв* заглушил.  
 c) *Рёв* звук выстрела заглушил.

READING 1: 'The sound of a shot muffled the roar.'

READING 2: 'The roar muffled the sound of a shot.'

4. a) Платье задело *весло*.  
 b) Платье *весло* задело.  
 c) *Весло* платье задело.

READING 1: 'The dress brushed against the oar.'

READING 2: 'The oar brushed against the dress.'

5. a) Мать любит *дочь*.  
 b) Мать *дочь* любит.  
 c) *Дочь* мать любит.

READING 1: 'The mother loves her daughter.'

READING 2: 'The daughter loves her mother.'

6. a) Троллейбус обогнал *автобус*.  
 b) Троллейбус *автобус* обогнал.  
 c) *Автобус* троллейбус обогнал.

READING 1: 'The trolleybus passed the bus.'

READING 2: 'The bus passed the trolleybus.'

Table A. Rated Accessibility of Meanings for NOM/ ACC in Experiment 1

|                                      | BELOW THE VERB |         | ABOVE THE VERB |         | SENTENCE-INITIAL |         |
|--------------------------------------|----------------|---------|----------------|---------|------------------|---------|
|                                      | MEAN. 1        | MEAN. 2 | MEAN. 1        | MEAN. 2 | MEAN. 1          | MEAN. 2 |
| (1) Лирика увлекла <i>физика</i> .   | 2.59           | 0.82    | 2.53           | 1.94    | 1.47             | 2.47    |
| (2) День сменяет <i>ночь</i> .       | 2.24           | 1.64    | 2.13           | 2.06    | no data          | no data |
| (6) Троллей обогнал <i>автобус</i> . | 2.82           | 1.47    | 2.53           | 1.59    | 2.53             | 1.29    |
| (4) Платье задело <i>весло</i> ,     | no data        | no data | 1.88           | 2.06    | 2.94             | 1.06    |
| (5) Мать любит <i>дочь</i> .         | 2.88           | 1.00    | 2.59           | 1.41    | 2.76             | 0.70    |
| (3) Звук . . . заглушил <i>рев</i> . | 2.41           | 1.47    | 2.53           | 1.18    | 2.88             | 0.82    |

## THE INSTR AMBIGUITY

7. a) Смирнов был послан на завод *директором*.  
 b) Смирнов *директором* был послан на завод.  
 c) *Директором* Смирнов был послан на завод.

READING 1: 'Smirnov was sent to the factory as a director.'

READING 2: 'Smirnov was sent to the factory by the director.'

8. a) Выпускник училища был отправлен в отряд *комиссаром*.  
 b) Выпускник училища *комиссаром* был отправлен в отряд.  
 c) *Комиссаром* выпускник училища был отправлен в отряд.

READING 1: 'The graduate of a military school was sent to the detachment as a commissar.'

READING 2: 'The graduate of a military school was sent to the detachment by the commissar.'

9. a) Этот опытный преподаватель был рекомендован в РОНО *инспектором*.  
 b) Этот опытный преподаватель *инспектором* был рекомендован в РОНО.  
 c) *Инспектором* этот опытный преподаватель был рекомендован в РОНО.

READING 1: 'This experienced teacher was recommended to RONO as an inspector.'

READING 2: 'This experienced teacher was recommended to RONO by the inspector.'

10. a) Один из научных сотрудников был назначен в лабораторию *руководителем* *хоздоговора*.  
 b) Один из научных сотрудников *руководителем хоздоговора* был назначен в лабораторию.  
 c) *Руководителем хоздоговора* один из научных сотрудников был назначен в лабораторию.

READING 1: 'One of the research colleagues was appointed to the lab as a leader of the paid project.'

READING 2: 'One of the research colleagues was appointed to the lab by the leader of the paid project.'

11. a) Александр Иванович был направлен в отдел технического контроля *заведующим*.  
 б) Александр Иванович *заведующим* был направлен в отдел технического контроля.  
 с) *Заведующим* Александр Иванович был направлен в отдел технического контроля.

READING 1: 'Alexandr Ivanovich was transferred to the department of technical control as a chairman.'

READING 2: 'Alexandr Ivanovich was transferred to the department of technical control by chairman.'

12. a) Московский журналист Крылов был командирован в областную газету *редактором*.  
 б) Московский журналист Крылов *редактором* был командирован в областную газету.  
 с) *Редактором* московский журналист Крылов был командирован в областную газету.

READING 1: 'Moscow journalist Krylov was delegated to the regional newspaper as an editor.'

READING 2: 'Moscow journalist Krylov was delegated to the regional newspaper by the editor.'

Table B. Rated Accessibility of Meanings for INSTR in Experiment 1

|                                                       | BELOW THE VERB |         | ABOVE THE VERB |         | SENTENCE-INITIAL |         |
|-------------------------------------------------------|----------------|---------|----------------|---------|------------------|---------|
|                                                       | MEAN. 1        | MEAN. 2 | MEAN. 1        | MEAN. 2 | MEAN. 1          | MEAN. 2 |
| (7) Смирнов был послан на завод <i>директором</i> .   | 2.29           | 1.65    | 1.35           | 2.94    | 1.41             | 2.41    |
| (8) Выпускник училища был отправлен в отряд . . .     | 2.29           | 1.59    | 2.06           | 2.06    | 1.59             | 2.41    |
| (11) Александр Иванович был направлен в отдел . . .   | 2.76           | 1.65    | 1.76           | 2.00    | 2.18             | 1.88    |
| (12) Московский журналист Крылов был командирован . . | 2.29           | 2.06    | 1.65           | 2.00    | 1.29             | 2.65    |
| (9) Этот опытный преподаватель был . . .              | 2.53           | 1.65    | 2.31           | 1.81    | 1.12             | 2.82    |
| (10) Один из научных сотрудников был назначен . .     | 2.71           | 1.06    | 2.29           | 1.53    | 1.55             | 2.51    |

## THE DAT AMBIGUITY

13. a) На сей раз пришлось сделать замечание *председателю кооператива*.  
 b) На сей раз пришлось *председателю кооператива* сделать замечание.  
 c) *Председателю кооператива* на сей раз пришлось сделать замечание.

READING 1: 'This time they had to reprimand the director of the coop.'

READING 2: 'This time the director of the coop had to reprimand.'

14. a) Приходилось многое объяснять *ассистенту*.  
 b) Приходилось *ассистенту* многое объяснять.  
 c) *Ассистенту* приходилось многое объяснять.

READING 1: 'They had to explain many things to the assistant.'

READING 2: 'The assistant had to explain many things.'

15. a) Из штаба приказали доставить *им* топливо.  
 b) Из штаба приказали *им* доставить топливо.  
 c) *Им* из штаба приказали доставить топливо.

READING 1: 'From the headquarters they ordered to deliver fuel to them.'

READING 2: 'From the headquarters they ordered them to deliver fuel.'

16. a) Нужно посоветовать прочесть *лектору* материал на более актуальную тему.  
 b) Нужно *лектору* посоветовать прочесть материал на более актуальную тему.  
 c) *Лектору* нужно посоветовать прочесть материал на более актуальную тему.

READING 1: 'It is needed to advise the lecturer to read material on a more current topic.'

READING 2: 'The lecturer needs to advise to read material on a more current topic.'

17. a) Необходимо направить запрос на всё требуемое оборудование *главному инженеру завода*.  
 b) Необходимо *главному инженеру завода* направить запрос на всё требуемое оборудование.  
 c) *Главному инженеру завода* необходимо направить запрос на всё требуемое оборудование.

READING 1: 'It is necessary to send a request for all the required equipment to the chief engineer of the plant.'

READING 2: 'It is necessary for the chief engineer of the plant to send a request for all the required equipment.'

18. a) Приходится объяснять принципы организации торговли *преподавателям*.  
 b) Приходится *преподавателям* объяснять принципы организации торговли.  
 c) *Преподавателям* приходится объяснять принципы организации торговли.

READING 1: 'They have to explain principles of commerce organization to the instructors.'

READING 2: 'The instructors have to explain principles of commerce organization.'

Table C. Rated Accessibility of Meanings for DAT in Experiment 1

|                                                         | BELOW THE VERB |         | ABOVE THE VERB |         | SENTENCE-INITIAL |         |
|---------------------------------------------------------|----------------|---------|----------------|---------|------------------|---------|
|                                                         | MEAN. 1        | MEAN. 2 | MEAN. 1        | MEAN. 2 | MEAN. 1          | MEAN. 2 |
| (13) На сей раз пришлось сделать замечание . . .        | 2.70           | 0.94    | 2.35           | 2.18    | 2.29             | 1.76    |
| (14) Приходилось многое объяснять <i>ассистенту</i> .   | 2.47           | 1.18    | 2.71           | 1.47    | 1.76             | 2.29    |
| (17) Необходимо направить запрос на всё требуемое . . . | 3.00           | 0.94    | 1.18           | 2.47    | 1.06             | 2.53    |
| (18) Приходится объяснять принципы организации . . .    | 2.59           | 1.41    | 1.59           | 2.18    | 1.82             | 1.94    |
| (15) Из штаба приказали доставить <i>им</i> топливо.    | 2.53           | 1.29    | 1.47           | 2.35    | 1.06             | 2.71    |
| (16) Нужно посоветовать прочитать <i>лектору</i> . . .  | 2.71           | 0.59    | 2.76           | 0.76    | 2.53             | 1.71    |

## APPENDIX 2. Experimental Materials for Experiment 2 (Chapter 4)

1.     a) Лирика увлекла *физика*.  
       b) Лирика *физика* увлекла.  
QUESTION: Увлекательна ли физика?  
          ‘Is physics attractive?’
2.     a) День сменяет *ночь*.  
       b) День *ночь* сменяет.  
QUESTION: День наступает?  
          ‘Is the day approaching?’
3.     a) Звук выстрела заглушил *рёв*.  
       b) Звук выстрела *рёв* заглушил.  
QUESTION: Звук выстрела громче рёва?  
          ‘Is the sound of the shot louder than the roar?’
4.     a) Платье задело *весло* .  
       b) Патье *весло* задело.  
QUESTION: Весло коснулось платья?  
          ‘Has the oar touched the dress?’
5.     a) Мать любит *дочь*.  
       b) Мать *дочь* любит.  
QUESTION: Дочь испытывает к матери любовь?  
          ‘Does the daughter feel love towards her mother?’

6. а) Троллейбус обогнал *автобус*.  
 б) Троллейбус *автобус* обогнал.

QUESTION: Автобус быстрее троллейбуса?

'Is the bus faster than the trolleybus?'

7. а) Солнце заслонило *облако*.  
 б) Солнце *облако* заслонило.

QUESTION: За солнцем не видно облака?

'Can't one see the cloud behind the sun?'

8. а) Общество организовало *предприятие*.  
 б) Общество *предприятие* организовало.

QUESTION: Общество организовано предприятием?

'Was the company organized by the plant?'

9. а) Сад окружает *огород*.  
 б) Сад *огород* окружает.

QUESTION: Сад расположен вокруг огорода?

'Is the orchid surrounded by the garden?'

10. а) Радость сменит *горе*.  
 б) Радость *горе* сменит.

QUESTION: Горе придёт на смену радости?

'Will grief replace joy?'

11. а) Банки стимулируют *фонды*.  
 б) Банки *фонды* стимулируют.

QUESTION: Банки стимулируются фондами?

'Are the banks stimulated by the funds?'

12. а) Постройки закрывают *деревья*.  
 б) Постройки *деревья* закрывают.

QUESTION: Постройки выше деревьев?

'Are the buildings higher than the trees?'

#### THE INSTR AMBIGUITY

13. а) Смирнов был послан на завод *директором*.  
 б) *Директором* Смирнов был послан на завод.

QUESTION: Смирнова послали на завод директором?

'Did they send Smirnov to the plant as the director?'

14. а) Выпускник училища был отправлен в отряд *комиссаром*.  
 б) *Комиссаром* выпускник училища был отправлен в отряд.

QUESTION: Выпускник училища был в отряде комиссаром?

'Was the graduate of the college commisar in the detachment?'

15. а) Этот опытный преподаватель был рекомендован в РОНО *инспектором*.  
 б) *Инспектором* этот опытный преподаватель был рекомендован в РОНО.  
 QUESTION: Этого преподавателя рекомендовали в РОНО инспектором?  
 'Was this instructor recommended to the Board of Education as an inspector?'
16. а) Один из научных сотрудников был назначен в лабораторию // *руководителем хоздоговора*.  
 б) *Руководителем хоздоговора* один из научных сотрудников // был назначен в лабораторию.  
 QUESTION: Руководитель хоздоговора назначил сотрудника в лабораторию?  
 'Did the leader of the project appoint the employee to the lab?'
17. а) Александр Иванович был направлен в отдел техконтроля *заведующим*.  
 б) *Заведующим* Александр Иванович был направлен в отдел техконтроля.  
 QUESTION: Заведующий направил Александра Ивановича в отдел техконтроля?  
 'Did the chairman send Alexander Ivanovich to the department of technical control?'
18. а) Московский журналист Крылов был командирован // в областную газету *редактором*.  
 б) *Редактором* московский журналист Крылов был командирован // в областную газету.  
 QUESTION: Редактор командировал Крылова в областную газету?  
 'Did the editor send Krylov to the local newspaper?'
19. а) Представитель Минфина был прислан в коммерческий банк *ревизором*.  
 б) *Ревизором* представитель Минфина был прислан в коммерческий банк.  
 QUESTION: Представителя Минфина прислали в коммерческий банк ревизором?  
 'Was the representative of the Ministry of Finance sent to the commercial bank as an auditor?'
20. а) Известный правозащитник был приглашён на международный // ежегодный семинар *ведущим лектором*.  
 б) *Ведущим лектором* известный правозащитник был приглашён // на международный ежегодный семинар.  
 QUESTION: Ведущий лектор пригласил на семинар известного правозащитника?  
 'Did the leading lecturer invite a well-known advocate for human rights to the seminar?'
21. а) Заслуженный мастер спорта был приглашён // в команду первой лиги *тренером*.  
 б) *Тренером* заслуженный мастер спорта был приглашён // в команду первой лиги.  
 QUESTION: Заслуженного мастера спорта пригласили в команду тренером?  
 'Did they invite the experienced athlete to the team as a coach?'
22. а) Директор НИИ был переведён в министерство *начальником главка*.  
 б) *Начальником главка* директор НИИ был переведён в министерство.  
 QUESTION: Директора НИИ перевели в министерство начальником главка?  
 'Was the director of the research institute transferred to the ministry as a chief of a department?'

23. а) Она рекомендована в сектор уголовного права // *главным научным сотрудником.*  
 б) *Главным научным сотрудником* она рекомендована // в сектор уголовного права.  
 QUESTION: Главный научный сотрудник рекомендовал ее в сектор права?  
 'Did the senior research colleague recommend her to the Law program?'

24. а) Американский специалист был рекомендован // в совет по реформам *экспертом.*  
 б) *Экспертом* американский специалист был рекомендован // в совет по реформам.  
 QUESTION: Эксперт рекомендовал американского специалиста в совет?  
 'Did the expert recommend the American specialist to the council?'

#### THE DAT AMBIGUITY

25. а) На сей раз пришлось сделать замечание *председателю кооператива.*  
 б) *Председателю кооператива* на сей раз пришлось сделать замечание.  
 QUESTION: Председатель кооператива сделал замечание?  
 'Did the director of the cooperative make a reprimand?'

26. а) Приходилось объяснять многое *ассистенту.*  
 б) *Ассистенту* приходилось многое объяснять.  
 QUESTION: Ассистент должен был многое объяснять?  
 'Did the assistant have to explain many things?'

27. а) Из штаба приказали доставить *им* топливо.  
 б) *Им* из штаба приказали доставить топливо.  
 QUESTION: Они получили приказ доставить топливо?  
 'Did they receive the order to deliver the fuel?'

28. а) Нужно посоветовать *лектору* прочитать материал // на более актуальную тему.  
 б) *Лектору* нужно посоветовать прочитать материал // на более актуальную тему.  
 QUESTION: Лектору посоветуют прочитать более актуальный материал?  
 'Was the lecturer advised to give a talk on a more current topic?'

29. а) Необходимо направить *главному инженеру* // запрос на всё требуемое оборудование.  
 б) *Главному инженеру* необходимо направить запрос // на всё требуемое оборудование.  
 QUESTION: Главному инженеру будет направлен запрос на оборудование?  
 'Will they send a request for equipment to the chief engineer?'

30. а) Приходится объяснять принципы торговли *преподавателям.*  
 б) *Преподавателям* приходится объяснять принципы торговли.  
 QUESTION: Преподавателям объясняют принципы торговли?  
 'Do they explain the principles of commerce to the instructors?'

31. а) Приходится показывать *мастерам*, как добиться // точности присверления.

б) *Мастерам* приходится показывать, как добиться // точности присверления.

QUESTION: Мастера показывают, как добиться точности?

'Do the experts show how to achieve precision?'

32. а) Следовало ещё вчера вручить *представителю оргкомитета* // долгожданную награду.

б) *Представителю оргкомитета* следовало ещё вчера // вручить долгожданную награду.

QUESTION: Представитель оргкомитета должен был получить награду?

'Did the representative of the organizing committee have to receive the award?'

33. а) Легко подчиняться *этому человеку*.

б) *Этому человеку* легко подчиняться.

QUESTION: Этот человек легко себе подчиняет?

'Is this man easy to obey?'

34. а) Давно пора вернуть *Маше* эту книгу.

б) *Маше* давно пора вернуть эту книгу.

QUESTION: Маше должны вернуть книгу?

'Did they have to return the book to Masha?'

35. а) Необходимо доказать экономическую целесообразность // этого изобретения *техническому отделу*.

б) *Техническому отделу* необходимо доказать // экономическую целесообразность этого изобретения.

QUESTION: Техотдел должен доказать экономическую целесообразность?

'Did the department of technical control have to show the economical efficiency?'

36. а) Следует предоставить *адвокату* все сведения // о результатах расследования.

б) *Адвокату* следует предоставить все сведения // о результатах расследования.

QUESTION: Адвокату должны быть предоставлены все сведения?

'Did they have to provide the attorney with the complete information?'

## APPENDIX 3: Experimental Materials for Experiment 3 (Chapter 7)

## SPLIT DPs

1. *Гостиная* придиричивому гостю понравилась *сразу же*.  
*Комната* придиричивому гостю понравилась *сразу же*.  
*Гостиная* придиричивому гостю понравилась *комната*.  
*Солнечная* придиричивому гостю понравилась *комната*.  
 'Living/room the picky guest liked *sunny/immediately*.'
2. *Дежурного* вызвали по местному радио *громко*.  
*Майора* вызвали по местному радио *громко*.  
*Дежурного* вызвали по местному радио *майора*.  
*Тюремного* вызвали по местному радио *майора*.  
 'On duty/major they called *jail/loudly* on the radio.'
3. *Больного* навещала соседская девочка *регулярно*.  
*Школьника* соседская девочка навещала *регулярно*.  
*Больного* навещала соседская девочка *школьника*.  
*Лежачего* навещала соседская девочка *школьника*.  
 'The sick/schoolboy a neighbor's girl visited *bed-ridden/regularly*.'
4. *Зубного* боится маленький ребёнок *очень*.  
*Врача* боится маленький ребёнок *очень*.  
*Зубного* боится маленький ребёнок *врача*.  
*Старого* боится маленький ребёнок *врача*.  
 'The dentist/doctor the small child is afraid of *old/very much*.'
5. *Рядового* прислал командир батальона *быстро*.  
*Солдата* прислал командир батальона *быстро*.  
*Рядового* прислал командир батальона *солдата*.  
*Опытного* прислал командир батальона *солдата*.  
 'The private/soldier the battalion commander sent *experienced/fast*.'
6. *Безработного* арестовали сотрудники КГБ *случайно*.  
*Инженера* арестовали сотрудники КГБ *случайно*.  
*Безработного* арестовали сотрудники КГБ *инженера*.  
*Иностранного* арестовали сотрудники КГБ *инженера*.  
 'The unemployed/engineer the KGB agents arrested *foreign/by mistake*.'
7. *Прохожего* испугал водитель скорой помощи *сиреной*.  
*Старика* испугал водитель скорой помощи *сиреной*.  
*Храпящего* испугал водитель скорой помощи *старика*.  
*Прохожего* испугал водитель скорой помощи *старика*.  
 'The passer-by/old man the ambulance driver scared *snoring/with the siren*.'
8. *Неизвестного* увидели играющие дети *внезапно*.  
*Человека* увидели играющие дети *внезапно*.  
*Неизвестного* увидели играющие дети *человека*.  
*Измощдённого* увидели играющие дети *человека*.  
 'An unknown/man the playing kids saw *emaciated /suddenly*.'

9. *Пленного* привели на очередной допрос *засветло*.  
*Капитана* привели на очередной допрос *засветло*.  
*Пленного* привели на очередной допрос *капитана*.  
*Финского* привели на очередной допрос *капитана*.  
 'The prisoner/captain they brought for next interrogation Finnish/at dawn.'
10. *Безпризорного* гоняли торговцы с рынка *постоянно*.  
*Мальчишку* гоняли торговцы с рынка *постоянно*.  
*Безпризорного* гоняли торговцы с рынка *мальчишку*.  
*Рассерженного* гоняли торговцы с рынка *мальчишку*.  
 'The homeless/boy the merchants were chasing away from the market angry/constantly.'
11. *Нищей* подавали местные прихожане *нечасто*.  
*Женщине* подавали местные прихожане *нечасто*.  
*Нищей* подавали местные прихожане *женщине*.  
*Новой* подавали местные прихожане *женщине*.  
 'The begger/woman they local parishioners gave money new/rarely.'
12. *Знакомого* расспрашивали наши друзья *полчаса*.  
*Доктора* расспрашивали наши друзья *полчаса*.  
*Знакомого* расспрашивали наши друзья *доктора*.  
*Сельского* расспрашивали наши друзья *доктора*.  
 'The acquaintance/doctor our friends kept asking questions country/for half hour.'
13. *Арестованного* привезли в Бутырскую тюрьму *днем*.  
*Вора* привезли в Бутырскую тюрьму *днем*.  
*Арестованного* привезли в Бутырскую тюрьму *вора*.  
*Известного* привезли в Бутырскую тюрьму *вора*.  
 'The arrested/thief they brought to the Butyrskaja jail well-known/in the afternoon.'
14. *Осуждённого* вывели из зала суда *в наручниках*.  
*Преступника* вывели из зала суда *в наручниках*.  
*Осуждённого* вывели из зала суда *преступника*.  
*Измученного* вывели из зала суда *преступника*.  
 'Indicted/criminal they led from the court room exhausted/cuffed.'
15. *Постового* выслушал приехавший следователь *внимательно*.  
*Милиционера* выслушал приехавший следователь *внимательно*.  
*Постового* выслушал приехавший следователь *милиционера*.  
*Дежурившего* выслушал приехавший следователь *милиционера*.  
 'The traffic/cop the detective listened to on duty/carefully.'
16. *Пострадавшего* доставили в ближайшую больницу *поспешно*.  
*Водителя* доставили в ближайшую больницу *поспешно*.  
*Пострадавшего* доставили в ближайшую больницу *водителя*.  
*Усталого* доставили в ближайшую больницу *водителя*.  
 'The injured/driver they took to the nearest hospital tired/hurridely.'

17. *Ваштенного* вызвал командир корабля *немедленно*.  
*Начальника* вызвал командир корабля *немедленно*.  
*Ваштенного* вызвал командир корабля *начальника*.  
*Торпедного* вызвал командир корабля *начальника*.  
 'The officer of the watch/officer the commander of the ship called *torpedo/immediately*.'
18. *Уполномоченного* назначали в разные комиссии *осмотрительно*.  
*Представителя* назначали в разные комиссии *осмотрительно*.  
*Уполномоченного* назначали в разные комиссии *представителя*.  
*Старательного* назначали в разные комиссии *представителя*.  
 'The authorized/representative they appointed to different commissions *assiduous/carefully*.'
19. *Учёного* пригласил районный прокурор *напрасно*.  
*Эксперта* пригласил районный прокурор *напрасно*.  
*Учёного* пригласил районный прокурор *эксперта*.  
*Важного* пригласил районный прокурор *эксперта*.  
 'The scholar/expert the district D.A. invited *important/for nothing*.'
20. *Смелого* боится любая пуля *всегда*.  
*Казака* боится любая пуля *всегда*.  
*Смелого* боится любая пуля *казака*.  
*Живого* боится любая пуля *казака*.  
 'The courageous/cossak any bullet shies away from *live/always*.'
21. *Военнопленных* направили на лесозаготовки *вчера*.  
*Чехов* направили на лесозаготовки *вчера*.  
*Военнопленных* направили на лесозаготовки *чехов*.  
*Новых* направили на лесозаготовки *чехов*.  
 'The POWs/czeck they sent to timber cutting *new/yesterday*.'
22. *Борзую* купили наши соседи *дешево*.  
*Собаку* купили наши соседи *дешево*.  
*Борзую* купили наши соседи *собаку*.  
*Шумную* купили наши соседи *собаку*.  
 'The borzoi/dog our neighbors bought *loud/cheap*.'
23. *Беспартийного* выбрали в общий президиум *единогласно*.  
*Композитора* выбрали в общий президиум *единогласно*.  
*Беспартийного* выбрали в общий президиум *композитора*.  
*Знаменитого* выбрали в общий президиум *композитора*.  
 'The non-party member/composer they elected into the presidium *famous/unanimously*.'
24. *Пьяного* отправили одного домой *напрасно*.  
*Приятеля* отправили одного домой *напрасно*.  
*Пьяного* отправили одного домой *приятеля*.  
*Вредного* отправили одного домой *приятеля*.  
 'The drunk/friend they sent home *nasty/unfair*.'

25. *Ведущего* заменял генеральный директор *временно*.  
*Инженера* заменял генеральный директор *временно*.  
*Ведущего* заменял генеральный директор *инженера*.  
*Ушедшего* заменял генеральный директор *инженера*.  
 'The chief/engineer the senior director replaced gone/temporarily.'
26. *Приезжего* поселили в лучшей гостинице *специально*.  
*Начальника* поселили в лучшей гостинице *специально*.  
*Приезжего* поселили в лучшей гостинице *начальника*.  
*Областного* поселили в лучшей гостинице *начальника*.  
 'The visitor/executive they put up at the best hotel regional/purposely.'
27. *Отдыхающего* разглядывала маленькая девочка *пристально*.  
*Пенсионера* разглядывала маленькая девочка *пристально*.  
*Отдыхающего* разглядывала маленькая девочка *пенсионера*.  
*Танцующего* разглядывала маленькая девочка *пенсионера*.  
 'The relaxing/retired man the little girl was staring at dancing/intently.'
28. *Сосланного* разыскивал уголовный розыск *повсюду*.  
*Бандита* разыскивал уголовный розыск *повсюду*.  
*Сосланного* разыскивал уголовный розыск *бандита*.  
*Беглого* разыскивал уголовный розыск *бандита*.  
 'In exile/gangster the criminal investigation department was looking for escaped/everwhere.'
29. *Голодающих* эвакуировали в южную губернию *медленно*.  
*Крестьян* эвакуировали в южную губернию *медленно*.  
*Голодающих* эвакуировали в южную губернию *крестьян*.  
*Волжских* эвакуировали в южную губернию *крестьян*.  
 'The starving/peasants they evacuated into the southern region the Volga/slowly.'
30. *Нападающего* удалил главный судья *решительно*.  
*Футболиста* удалил главный судья *решительно*.  
*Нападающего* удалил главный судья *футболиста*.  
*Небрежного* удалил главный судья *футболиста*.  
 'The forward/soccer player the referee removed from the field sloppy/resolutely.'
31. *Нарочного* захватили лесные партизаны *недавно*.  
*Курьера* захватили лесные партизаны *недавно*.  
*Нарочного* захватили лесные партизаны *курьера*.  
*Тайного* захватили лесные партизаны *курьера*.  
 'The messenger/courier the guerrillas captured secret/recently.'
32. *Часового* сменили с ночного поста *внезапно*.  
*Курсанта* сменили с ночного поста *внезапно*.  
*Часового* сменили с ночного поста *курсанта*.  
*Старшего* сменили с ночного поста *курсанта*.  
 'The sentry/cadet they changed from the night shift senior/unexpectedly.'

## SPLIT PPs

1. *В ванную* вернулся сосед по квартире *обратно*.  
*В комнату* вернулся сосед по квартире *обратно*.  
*В ванную* вернулся сосед по квартире комнату.  
*В большую* вернулся сосед по квартире комнату.  
 'Into the bath/room the neighbor in the apartment returned big/again.'
2. *О знакомой* вспоминал мой двоюродный брат *постоянно*.  
*О студентке* вспоминал мой двоюродный брат *постоянно*.  
*О знакомой* вспоминал мой двоюродный брат студентке.  
*О красивой* вспоминал мой двоюродный брат студентке.  
 'About the acquaintance/student my cousin through beautiful/constantly.'
3. *К посевной* подготовилось передовое хозяйство *блестяще*.  
*К компании* подготовилось передовое хозяйство *блестяще*.  
*К посевной* подготовилось передовое хозяйство компании.  
*К выборной* подготовилось передовое хозяйство компании.  
 'For sowing/campaign the foremost collective farm prepared election/impaccably.'
4. *С горничной* разговаривал новый постоялец *спокойно*.  
*С девушкой* разговаривал новый постоялец *спокойно*.  
*С горничной* разговаривал новый постоялец девушкой.  
*С незнакомой* разговаривал новый постоялец девушкой.  
 'With the maid/girl the new visitor talked unknown/quietly.'
5. *К присяжным* обратится опытный адвокат *обязательно*.  
*К заседателям* обратится опытный адвокат *обязательно*.  
*К присяжным* обратится опытный адвокат заседателям.  
*К народным* обратится опытный адвокат заседателям.  
 'To the jurors/ the experienced attorney will speak people's/definitely.'
6. *У рулевого* отобрал капитан штурвал *сегодня*.  
*У матроса* отобрал капитан штурвал *сегодня*.  
*У рулевого* отобрал капитан штурвал матроса.  
*У неопытного* отобрал капитан штурвал матроса.  
 'From the helmsman/sailor the captain took away the steering control inexperienced/today.'
7. *На слепого* набросились дворовые собаки *неожиданно*.  
*На попрошайку* набросились дворовые собаки *неожиданно*.  
*На слепого* набросились дворовые собаки попрошайку.  
*На нахального* набросились дворовые собаки попрошайку.  
 'After the blind/begger the dogs from the yard came insolent/unexpectedly.'
8. *От прокажённого* отворачивались деревенские жители *поспешно*.  
*От бродяги* отворачивались деревенские жители *поспешно*.  
*От прокажённого* отворачивались деревенские жители бродяги.  
*От страшного* отворачивались деревенские жители бродяги.  
 'From the leper/tramp the village people turned away ugly/hurriedly.'

9. *Над мёртвым* склонилась плачущая женщина *низко*.  
*Над телом* склонилась плачущая женщина *низко*.  
*Над мёртвым* склонилась плачущая женщина *телом*.  
*Над холодным* склонилась плачущая женщина *телом*.  
 'Over the dead/body the crying woman was leaning cold/low.'
10. *У бедных* забрали последние деньги *вчера*.  
*У людей* забрали последние деньги *вчера*.  
*У бедных* забрали последние деньги *людей*.  
*У сельских* забрали последние деньги *людей*.  
 'From the country/people they took their last money poor/yesterday.'
11. *На хромого* набросилась разъярённая толпа *быстро*.  
*На калеку* набросилась разъярённая толпа *быстро*.  
*На хромого* набросилась разъярённая толпа *калеку*.  
*На мрачного* набросилась разъярённая толпа *калеку*.  
 'On the limping/cripple the enraged crowd pounce goomy/fast.'
12. *На рабочего* возлагали большие надежды *напрасно*.  
*На паренька* возлагали большие надежды *напрасно*.  
*На рабочего* возлагали большие надежды *паренька*.  
*На решительного* возлагали большие надежды *паренька*.  
 'On the working/young man they put many hopes determined/in vain.'
13. *С полицейским* приключались разные истории *ежедневно*.  
*С сержантом* приключались разные истории *ежедневно*.  
*С полицейским* приключались разные истории *сержантом*.  
*С отставным* приключались разные истории *сержантом*.  
 'To the policeman/sergeant all kinds of situations happened retired/every day.'
14. *С дворовыми* общались хуторские крестьяне *охотно*.  
*С людьми* общались хуторские крестьяне *охотно*.  
*С дворовыми* общались хуторские крестьяне *людьми*.  
*С редкими* общались хуторские крестьяне *людьми*.  
 'With the home/servants the farm peasants communicated few/happily.'
15. *Перед батальонным* выстроились молодые новобранцы *постепенно*.  
*Перед командиром* выстроились молодые новобранцы *постепенно*.  
*Перед батальонным* выстроились молодые новобранцы *командиром*.  
*Перед недовольным* выстроились молодые новобранцы *командиром*.  
 'In front of the batallion/commander the young recruits lined up dissatisfied/gradually.'
16. *С неуспевающим* занимался лучший студент *достаточно*.  
*Со школьником* занимался лучший студент *достаточно*.  
*С неуспевающим* занимался лучший студент *школьником*.  
*С талантливым* занимался лучший студент *школьником*.  
 'With the backward/schoolboy the best student studied gifted/long enough.'
17. *С беременной* гулял молодой человек *долго*.  
*С женой* гулял молодой человек *долго*.  
*С беременной* гулял молодой человек *женой*.  
*С юной* гулял молодой человек *женой*.

18. *В докладной* перечислены были все участники *поимённо*.  
*В записке* перечислены были все участники *поимённо*.  
*В докладной* перечислены были все участники *записке*.  
*В секретной* перечислены были все участники *записке*.
19. *Из-за крёстной* волновался молодой человек *обычно*.  
*Из-за матери* волновался молодой человек *обычно*.  
*Из-за крёстной* волновался молодой человек *матери*.  
*Из-за старой* волновался молодой человек *матери*.
20. *За сумасшедшим* приехали из ближайшей больницы *мгновенно*.  
*За пациентом* приехали из ближайшей больницы *мгновенно*.  
*За сумасшедшим* приехали из ближайшей больницы *пациентом*.  
*За беспокойным* приехали из ближайшей больницы *пациентом*.
21. *За связным* послал партизанский командир *неохотно*.  
*За радистом* послал партизанский командир *неохотно*.  
*За связным* послал партизанский командир *радистом*.  
*За боевым* послал партизанский командир *радистом*.
22. *Над умиряющим* читал священник молитвы *печально*.  
*Над стариком* читал священник молитвы *печально*.  
*Над умиряющим* читал священник молитвы *стариком*.  
*Над страдающим* читал священник молитвы *стариком*.
23. *У придворного* собирались тайные заговорщики *ежедневно*.  
*У художника* собирались тайные заговорщики *ежедневно*.  
*У придворного* собирались тайные заговорщики *художника*.  
*У известного* собирались тайные заговорщики *художника*.
24. *Про святого* рассказывали чудесные легенды *давно*.  
*Про князя* рассказывали чудесные легенды *давно*.  
*Про святого* рассказывали чудесные легенды *князя*.  
*Про киевского* рассказывали чудесные легенды *князя*.
25. *У несчастного* погибла вся семья *сразу*.  
*У юноши* погибла вся семья *сразу*.  
*У несчастного* погибла вся семья *юноши*.  
*У этого* погибла вся семья *юноши*.
26. *От звеньёвого* вернулся колхозный механик *заполночь*.  
*От бригадира* вернулся колхозный механик *заполночь*.  
*От звеньёвого* вернулся колхозный механик *бригадира*.  
*От полевого* вернулся колхозный механик *бригадира*.
27. *К участковому* отправились сердитые соседи *необдуманно*.  
*К милиционеру* отправились сердитые соседи *необдуманно*.  
*К участковому* отправились сердитые соседи *милиционеру*.  
*К старшему* отправились сердитые соседи *милиционеру*.

28. *О безумном* рассказывали фантастические истории *искренне*.  
*О писателе* рассказывали фантастические истории *искренне*.  
*О безумном* рассказывали фантастические истории *писателе*.  
*О детском* рассказывали фантастические истории *писателе*.
29. *С подшефным* занимался назначенный старшеклассник *серьёзно*.  
*С пионером* занимался назначенный старшеклассник *серьёзно*.  
*С подшефным* занимался назначенный старшеклассник *пионером*.  
*С ленивым* занимался назначенный старшеклассник *пионером*.
30. *О подопечном* думал стареющий дядюшка *изредка*.  
*О ребёнке* думал стареющий дядюшка *изредка*.  
*О подопечном* думал стареющий дядюшка *ребёнке*.  
*О растущем* думал стареющий дядюшка *ребёнке*.
31. *К ссыльному* отправили партийного курьера *машиной*.  
*К секретарю* отправили партийного курьера *машиной*.  
*К ссыльному* отправили партийного курьера *секретарю*.  
*К районному* отправили партийного курьера *секретарю*.
32. *Для неграмотных* открыли новую школу *летом*.  
*Для детей* открыли новую школу *летом*.  
*Для неграмотных* открыли новую школу *детей*.  
*Для заводских* открыли новую школу *детей*.

## APPENDIX 4: Experimental Materials for Experiment 4 (Chapter 7)

## QUESTIONNAIRE A

## SHORT FRAGMENTS

## VERSION 1

- |                  |       |
|------------------|-------|
| 1. Гостиная      | _____ |
| 2. Солнечная     | _____ |
| 3. Дежурного     | _____ |
| 4. Тюремного     | _____ |
| 5. Больного      | _____ |
| 6. Лежачего      | _____ |
| 7. Зубного       | _____ |
| 8. Старого       | _____ |
| 9. Рядового      | _____ |
| 10. Опытного     | _____ |
| 11. Безработного | _____ |
| 12. Иностранного | _____ |
| 13. Прохожего    | _____ |
| 14. Храпящего    | _____ |
| 15. Неизвестного | _____ |
| 16. Измождённого | _____ |
| 17. Пленного     | _____ |

18. Финского \_\_\_\_\_
19. Беспризорного \_\_\_\_\_
20. Рассерженного \_\_\_\_\_
21. Нищей \_\_\_\_\_
22. Новой \_\_\_\_\_
23. Знакомого \_\_\_\_\_
24. Сельского \_\_\_\_\_
25. Арестованного \_\_\_\_\_
26. Известного \_\_\_\_\_
27. Осуждённого \_\_\_\_\_
28. Измученного \_\_\_\_\_
29. Постового \_\_\_\_\_
30. Дежурившего \_\_\_\_\_
31. Пострадавшего \_\_\_\_\_
32. Усталого \_\_\_\_\_

#### MEDIUM FRAGMENTS

1. Вахтенного вызвал \_\_\_\_\_
2. Торпедного вызвал \_\_\_\_\_
3. Уполномоченного назначали \_\_\_\_\_
4. Старательного назначали \_\_\_\_\_
5. Учёного пригласил \_\_\_\_\_
6. Важного пригласил \_\_\_\_\_
7. Смелого боится \_\_\_\_\_
8. Живого боится \_\_\_\_\_
9. Военнопленных направили \_\_\_\_\_
10. Новых направили \_\_\_\_\_
11. Борзую купили \_\_\_\_\_
12. Шумную купили \_\_\_\_\_
13. Беспартийного выбрали \_\_\_\_\_
14. Знаменитого выбрали \_\_\_\_\_
15. Пьяного отправили \_\_\_\_\_
16. Вредного отправили \_\_\_\_\_
17. Ведущего заменял \_\_\_\_\_
18. Ушедшего заменял \_\_\_\_\_
19. Приезжего поселили \_\_\_\_\_
20. Областного поселили \_\_\_\_\_
21. Отдыхающего разглядывала \_\_\_\_\_
22. Танцующего разглядывала \_\_\_\_\_
23. Сосланного разыскивал \_\_\_\_\_
24. Беглого разыскивал \_\_\_\_\_
25. Голодающих эвакуировали \_\_\_\_\_
26. Волжских эвакуировали \_\_\_\_\_
27. Нападающего удалил \_\_\_\_\_
28. Небрежного удалил \_\_\_\_\_
29. Нарочного захватили \_\_\_\_\_
30. Тайного захватили \_\_\_\_\_
31. Часового сменили \_\_\_\_\_
32. Старшего сменили \_\_\_\_\_

## VERSION 2

1. Вахтенного \_\_\_\_\_
2. Торпедного \_\_\_\_\_
3. Уполномоченного \_\_\_\_\_
4. Старательного \_\_\_\_\_
5. Учёного \_\_\_\_\_
6. Важного \_\_\_\_\_
7. Смелого \_\_\_\_\_
8. Живого \_\_\_\_\_
9. Военнопленных \_\_\_\_\_
10. Новых \_\_\_\_\_
11. Борзую \_\_\_\_\_
12. Шумную \_\_\_\_\_
13. Беспартийного \_\_\_\_\_
14. Знаменитого \_\_\_\_\_
15. Пьяного \_\_\_\_\_
16. Вредного \_\_\_\_\_
17. Ведущего \_\_\_\_\_
18. Ушедшего \_\_\_\_\_
19. Приезжего \_\_\_\_\_
20. Областного \_\_\_\_\_
21. Отдыхающего \_\_\_\_\_
22. Танцующего \_\_\_\_\_
23. Сосланного \_\_\_\_\_
24. Беглого \_\_\_\_\_
25. Голодающих \_\_\_\_\_
26. Волжских \_\_\_\_\_
27. Нападающего \_\_\_\_\_
28. Небрежного \_\_\_\_\_
29. Нарочного \_\_\_\_\_
30. Тайного \_\_\_\_\_
31. Часового \_\_\_\_\_
32. Старшего \_\_\_\_\_

## MEDIUM FRAGMENT

1. Гостиная понравилась \_\_\_\_\_
2. Солнечная понравилась \_\_\_\_\_
3. Дежурного вызвали \_\_\_\_\_
4. Тюремного вызвали \_\_\_\_\_
5. Больного навещала \_\_\_\_\_
6. Лежачего навещала \_\_\_\_\_
7. Зубного боится \_\_\_\_\_
8. Старого боится \_\_\_\_\_
9. Рядового прислал \_\_\_\_\_
10. Опытного прислал \_\_\_\_\_
11. Безработного арестовали \_\_\_\_\_
12. Иностранного арестовали \_\_\_\_\_
13. Прохожего испугал \_\_\_\_\_
14. Храпящего испугал \_\_\_\_\_
15. Неизвестного увидели \_\_\_\_\_

- |                             |       |
|-----------------------------|-------|
| 16. Измождённого увидели    | _____ |
| 17. Пленного привели        | _____ |
| 18. Финского привели        | _____ |
| 19. Беспризорного гоняли    | _____ |
| 20. Рассерженного гоняли    | _____ |
| 21. Нищей подавали          | _____ |
| 22. Новой подавали          | _____ |
| 23. Знакомого расспрашивали | _____ |
| 24. Сельского расспрашивали | _____ |
| 25. Арестованного привезли  | _____ |
| 26. Известного привезли     | _____ |
| 27. Осуждённого вывели      | _____ |
| 28. Измученного вывели      | _____ |
| 29. Постового выслушал      | _____ |
| 30. Дежурившего выслушал    | _____ |
| 31. Пострадавшего доставили | _____ |
| 32. Усталого доставили      | _____ |

## QUESTIONNAIRE B

## VERSION 1

## ONE WORD INSTRUCTIONS

- |                                                |       |
|------------------------------------------------|-------|
| 1. Вахтенного вызвал корабельный командир      | _____ |
| 2. Торпедного вызвал корабельный командир      | _____ |
| 3. Уполномоченного назначали в разные комиссии | _____ |
| 4. Старательного назначали в разные комиссии   | _____ |
| 5. Учёного пригласил районный прокурор         | _____ |
| 6. Важного пригласил районный прокурор         | _____ |
| 7. Смелого боится любая пуля                   | _____ |
| 8. Живого боится любая пуля                    | _____ |
| 9. Военнопленных направили на лесозаготовки    | _____ |
| 10. Новых направили направили на лесозаготовки | _____ |
| 11. Борзую купили наши соседи                  | _____ |
| 12. Шумную купили наши соседи                  | _____ |
| 13. Беспартийного выбрали в общий президиум    | _____ |
| 14. Знаменитого выбрали в общий президиум      | _____ |
| 15. Пьяного отправили одного домой             | _____ |
| 16. Вредного отправили одного домой            | _____ |
| 17. Ведущего заменял генеральный директор      | _____ |
| 18. Ушедшего заменял генеральный директор      | _____ |
| 19. Приезжего поселили в лучшей гостинице      | _____ |
| 20. Областного поселили в лучшей гостинице     | _____ |
| 21. Отдыхающего разглядывала маленькая девочка | _____ |
| 22. Танцующего разглядывала маленькая девочка  | _____ |
| 23. Сосланного разыскивал уголовный розыск     | _____ |
| 24. Беглого разыскивал уголовный розыск        | _____ |
| 25. Голодающих эвакуировали в южную губернию   | _____ |
| 26. Волжских эвакуировали в южную губернию     | _____ |
| 27. Нападающего удалил главный судья           | _____ |





22. Танцующего разглядывала маленькая девочка
23. Сосланного разыскивал уголовный розыск
24. Беглого разыскивал уголовный розыск
25. Голодающих эвакуировали в южную губернию
26. Волжских эвакуировали в южную губернию
27. Нападающего удалил главный судья
28. Небрежного удалил главный судья
29. Нарочного захватили лесные партизаны
30. Тайного захватили лесные партизаны
31. Часового сменили с ночного поста
32. Старшего сменили с ночного поста

---

---

---

---

---

---

---

---

---

---

---

---

Table D . %Adj Interpretations of Ambiguous N/ Adj Critical Element in Experiment 4

|                                      | SHORT | MEDIUM | LONG: 1<br>WORD | LONG: 1<br>NOUN |
|--------------------------------------|-------|--------|-----------------|-----------------|
| <i>arestovannogo</i> 'arrested`      | 0     | 0      | 12.5            | 62.5            |
| <i>bespartijnogo</i> 'not member`    | 25    | 0      | 25              | 0               |
| <i>besprizornogo</i> 'homeless`      | 37.5  | 25     | 25              | 37.5            |
| <i>bezrabotnogo</i> unemployed       | 50    | 0      | 12.5            | 37.5            |
| <i>bol'nogo</i> 'sick`               | 25    | 12.5   | 25              | 37.5            |
| <i>borzuju</i> 'borzoj`              | 37.5  | 0      | 37.5            | 37.5            |
| <i>časovogo</i> 'sentry`             | 12.5  | 0      | 0               | 0               |
| <i>dežurnogo</i> 'on duty`           | 37.5  | 25     | 0               | 37.5            |
| <i>golodajuščix</i> 'starving`       | 37.5  | 0      | 0               | 12.5            |
| <i>gostinaja</i> 'living-room`       | 0     | 0      | 0               | 0               |
| <i>napadjuščego</i> 'forward`        | 12.5  | 0      | 0               | 0               |
| <i>naročnogo</i> 'courier`           | 0     | 0      | 0               | 0               |
| <i>neizvestnogo</i> 'unknown`        | 75    | 37.5   | 75              | 75              |
| <i>niščej</i> 'beggar woman`         | 25    | 0      | 12.5            | 12.5            |
| <i>osuždennogo</i> 'convicted`       | 12.5  | 0      | 0               | 50              |
| <i>otdyxajuščego</i> 'vacationer`    | 62.5  | 0      | 0               | 25              |
| <i>plennogo</i> 'prisoner`           | 37.5  | 0      | 37.5            | 50              |
| <i>postovogo</i> 'traffic cop`       | 50    | 25     | 0               | 37.5            |
| <i>postradavšego</i> 'injured`       | 0     | 12.5   | 0               | 25              |
| <i>priežžego</i> 'visitor`           | 37.5  | 0      | 12.5            | 0               |
| <i>proxožego</i> 'passer-by`         | 12.5  | 0      | 0               | 12.5            |
| <i>p'janogo</i> 'drunk`              | 50    | 0      | 12.5            | 25              |
| <i>rjadovogo</i> 'private`           | 12.5  | 12.5   | 12.5            | 50              |
| <i>smelogo</i> 'courageous`          | 87.5  | 28.6   | 37.5            | 37.5            |
| <i>soslannogo</i> 'in exile`         | 71.4  | 0      | 0               | 12.5            |
| <i>učenogo</i> 'scholar`             | 12.5  | 0      | 0               | 0               |
| <i>upolnomočenn.</i> 'authorized`    | 0     | 0      | 12.5            | 12.5            |
| <i>vaxtennogo</i> 'officer of watch` | 37.5  | 0      | 0               | 25              |
| <i>veduščego</i> 'chief`             | 37.5  | 0      | 0               | 25              |
| <i>voennoplennyx</i> 'POWs`          | 0     | 0      | 0               | 12.5            |
| <i>znakomogo</i> 'acquaintance`      | 28.6  | 25     | 12.5            | 37.5            |
| <i>zubnogo</i> 'dentist`             | 100   | 0      | 50              | 100             |

Table E. %Adj Interpretations of Unambiguous Adj Critical Element in Experiment 4

|                                   | SHORT | MEDIUM | LONG:<br>1 WORD | LONG:<br>1 NOUN |
|-----------------------------------|-------|--------|-----------------|-----------------|
| <i>beglogo</i> 'runaway`          | 75    | 37.5   | 50              | 75              |
| <i>dežurnošego</i> 'duty`         | 50    | 75     | 62.5            | 75              |
| <i>finskogo</i> 'Finnish`         | 100   | 100    | 75              | 100             |
| <i>inostrannogo</i> 'foreign`     | 100   | 100    | 100             | 100             |
| <i>izmoždennogo</i> 'exhaust`     | 100   | 87.5   | 100             | 100             |
| <i>izmučenogogo</i> 'tortured`    | 75    | 87.5   | 100             | 87.5            |
| <i>izvestnogogo</i> 'well-known`  | 100   | 100    | 87.5            | 100             |
| <i>ležačegogo</i> 'bed-ridden`    | 37.5  | 50     | 62.5            | 87.5            |
| <i>nebrežnogogo</i> 'sloppy`      | 75    | 75     | 87.5            | 87.5            |
| <i>novoj</i> 'new`                | 100   | 87.5   | 62.5            | 85.7            |
| <i>novyx</i> 'new`                | 100   | 37.5   | 62.5            | 87.5            |
| <i>oblastnogogo</i> 'regional`    | 100   | 85.7   | 75              | 87.5            |
| <i>opytnogogo</i> 'experienced`   | 100   | 100    | 87.5            | 100             |
| <i>rasseržennogogo</i> 'angry`    | 100   | 100    | 87.5            | 100             |
| <i>sel'skogogo</i> 'country`      | 100   | 100    | 87.5            | 100             |
| <i>solnečnaja</i> 'sunny`         | 100   | 75     | 87.5            | 100             |
| <i>staratel'nogogo</i> 'diligent` | 87.5  | 12.5   | 57.1            | 87.5            |
| <i>starogogo</i> 'old`            | 100   | 100    | 87.5            | 100             |
| <i>staršegogo</i> 'senior`        | 75    | 57.1   | 75              | 50              |
| <i>šumnuju</i> 'noisy`            | 100   | 100    | 100             | 100             |
| <i>tajnogogo</i> 'secret`         | 100   | 87.5   | 100             | 100             |
| <i>tancujuščegogo</i> 'dancing`   | 87.5  | 28.6   | 50              | 75              |
| <i>tjuremnogogo</i> 'jail`        | 100   | 75     | 75              | 100             |
| <i>torpednogogo</i> 'torpedo`     | 100   | 12.5   | 28.6            | 57.1            |
| <i>ušedšegogo</i> 'gone`          | 25    | 0      | 0               | 50              |
| <i>ustalogogo</i> 'tired`         | 100   | 85.7   | 75              | 100             |
| <i>važnogogo</i> 'important`      | 100   | 100    | 100             | 100             |
| <i>volžskix</i> 'Volga`           | 87.5  | 37.5   | 50              | 75              |
| <i>vrednogogo</i> 'malicious`     | 62.5  | 57.1   | 71.4            | 87.5            |
| <i>xrapjaščegogo</i> 'snoring`    | 75    | 42.9   | 75              | 75              |
| <i>živogogo</i> 'live`            | 100   | 83.3   | 71.4            | 87.5            |
| <i>znamenitogogo</i> 'famous`     | 87.5  | 100    | 75              | 100             |

## REFERENCES

- Abney, S. (1987) *The English Noun Phrase in its Sentential Aspect*. Doctoral Dissertation, M.I.T., Cambridge, Mass.
- Androutsopoulou, A. (1997) *Split DP's, Focus, and Scrambling in Modern Greek*. Talk presented at the WCCFL 16, University of Washington, Seattle.
- Austin, P. & Bresnan, J. (1996) Non-Configurationality in Australian Aboriginal Languages. *Natural Languages and Linguistic Theory* 14, 215-268.
- Avrutin, S. (1994) The Structural Position of Bound Variables in Russian. *Linguistic Inquiry* 25, 709-727.
- Bader, M. (1994) Syntactic-Function Ambiguities. *Folia Linguistica* XXVIII, 1-2, 5-66.
- Bader, M. And Meng, M. (1996) *Case and Agreement in Processing Subject-Object Ambiguities*. Talk presented at the AMLAP 1996.
- Baker, M. (1991) On Some Subject/Object Non-Asymmetries in Mohawk. *Natural Languages and Linguistic Theory* 9, 537-576.
- Bailyn, J. (1995) *A Configurational Approach to Russian "Free" Word Order*. Doctoral Dissertation, Cornell University, Ithaca, NY.
- Bayer, J. & Kornfilt, J. (1994) Against Scrambling as an Instance of Move-Alpha. In Corver, N. and van Riemsdijk, H. (Eds.) *Studies on Scrambling: Movement and Non-Movement Approaches to Free-Word Order Phenomena*. Mouton de Gruyter, Berlin.
- Besten, H. den & Webelhuth, G. (1990) Stranding. In G. Grewendorf and W. Sternefeld (Eds.) *Scrambling and Barriers*. John Benjamins Publishing Company, Amsterdam, 77-92.
- Berwick, R. & Fong, S. (1995) Madama Butterfly Redux: Parsing English and Japanese with a Principles and Parameters Approach. In Mazuka, R. and Nagai, N. (Eds.) *Japanese Sentence Processing*. Lawrence Erlbaum, Hillside, NJ.
- Bivon, R. (1971) *Element Order*. Studies in the Modern Russian Language vol. 7, Cambridge University Press, Cambridge, England.
- Bošković, Ž. (1996) Fronting Wh-Phrases in Serbo-Croatian. In Lindseth, M. and Franks, S. (Eds.) *The Fifth Annual Workshop on Formal Approaches to Slavic Linguistics, the Indiana Meeting*, Michigan Slavic Publications, Ann Arbor, 86-107.
- Bošković, Ž. and Takahashi, D. (1995) *Scrambling and Last Resort*. Ms., University of Connecticut and Graduate School and University Center, the City University of New York.
- Bresnan, J. (Ed.) (1982) *The Mental Representation of Grammatical Relations*. The M.I.T. Press, Cambridge, Mass.
- Cinque, G. (1993) A Null Theory of Phrase and Compound Stress. *Linguistic Inquiry* 24, 239-298.
- Chomsky, N. (1986) *Barriers*. The M.I.T. Press, Cambridge, Mass.

- Chomsky, N. (1991) Some Notes on Economy of Derivations and Representations. In R. Freidin (Ed.), *Principles and Parameters in Comparative Grammar*, M.I.T. Press, Cambridge, Mass.
- Chomsky, N. (1993) A Minimalist Program for Linguistic Theory. In S. Kayser & M. Halle (Eds.), *The View from Building 20*, The M.I.T. Press, Cambridge, Mass.
- Chomsky, N. (1995) *The Minimalist Program*. The M.I.T. Press, Cambridge, Mass.
- Cuetos, F. and Mitchell, D. (1988) Crosslinguistic Differences in Parsing: Restrictions on the Use of the Late Closure Strategy in Spanish. *Cognition* 30, 73-105.
- Cuetos, F., Mitchell, D. And Corley, M. (1996) Exposure-Based Models of Human Parsing: Evidence for the Use of Coarse-Grained (Nonlexical) Statistical Records. *Journal of Psycholinguistic Research* 24, 469-488.
- De Vincenzi, M. (1991) *Syntactic Parsing Strategies in Italian. The Minimal Chain Principle*. Kluwer Academic, Dordrecht.
- Engdahl, E. (1980) Wh Constructions in Swedish and the Relevance of Subjacency. *Cahiers Linguistique d'Ottawa* 9, 89-108.
- Erteschik-Shir, N. (1993) *The Dynamics of Focus Structure*. Ms., Ben Gurion University of the Negev.
- Fanselow, G. (1990) Scrambling as NP-Movement. In Grewendorf, G. and Sternefeld, W. (Eds.) *Scrambling and Barriers*. John Benjamins Publishing Company, Amsterdam.
- Ferreira, F. And Fodor, J. D. (In press) *Reanalysis and Sentence Processing*. Kluwer Academic Press, Dordrecht.
- Fodor, J. D. (1978) Parsing Strategies and Constraints on Transformations. *Linguistic Inquiry* 9, 427-473.
- Fodor, J. D. (1996)
- Fodor, J. D. and Inoue, A. (1995) The Diagnosis and Cure of Garden Path. *Journal of Psycholinguistic Research* 23, 407-434.
- Fodor, J. A., Bever, T. G. and Garrett, M. F. (1974) *The Psychology of Language: AN Introduction to Psycholinguistics and Generative Grammar*. McGraw-Hill, New York.
- Forster, K. and Forster, J. (1990) *User's Guide to the DMASTR Display System. Laboratory Software for Mental Chronometry*. Unpublished ms., University of Arizona, Tucson, AZ.
- Fowler, G. (1987) The Grammatical Relevance of Theme/Rheme Partition. *Chicago Linguistics Society 23: Papers from the 23rd Annual Regional Meeting of the Chicago Linguistics Society*. Part I: The General Session. Chicago, Chicago Linguistics Society, 93-104.
- Frank, R., Lee, Y.-S. & Rambow, O. (1992) Scrambling as Non-Operator Movement and the Special Status of Subjects. In *Proceedings of LCJL* 3, 135-154.
- Franks, S. (1993) *On Scrambling in Colloquial Russian*. Ms., Indiana University.

- Franks, S. and House, R. (1982) Genitive Theme in Russian. *Chicago Linguistics Society 18: Papers from the 18th Annual Regional Meeting of the Chicago Linguistics Society. Part I: The General Session.* Chicago, Chicago Linguistics Society, .
- Franks, S. and Progovac, L.. (1994) On the Placement of Serbo-Croatian Clitics. *Indiana Slavic Studies*, 7, 69-78.
- Frazier, L. (1978) *On Comprehending Sentences: Syntactic Parsing Strategies.* Doctoral Dissertation. University of Connecticut, Storrs. Bloomington: The Indiana University Linguistics Club.
- Frazier, L. (1987) Sentence Processing: A Tutorial Review. In Colheart. M. (Ed.) *Attention and Performance XII: The Psychology of Reading.* Hillsdale, NJ: Erlbaum.
- Frazier, L. (1993) Processing Dutch Sentence Structures. *Journal of Psycholinguistic Research* 22, 85-108.
- Frazier, L. and Clifton, C. (1996) *Construal.* The M.I.T. Press, Cambridge, Mass.
- Frazier, L. and Fodor, J. D. (1978) The Sausage Machine: A New Two-Stage Parsing Model. *Cognition* 6, 291-325.
- Frazier, L. and Rayner, K. (1987) Resolution of Syntactic category Ambiguities: Eye Movements in Parsing Lexically Ambiguous Sentences. *Journal of Memory and Language* 26, 505-526.
- Friederici, A. (In press) Diagnosis and Reanalysis: Two Processing aspects the brain may differentiate. In Ferreira, F. And Fodor, J. D. (Eds.) *Reanalysis and Sentence Processing.* Kluwer Academic Press, Dordrecht.
- Gazdar, G., Klein, E., Pullum, G. and Sag, I. (1985) *Generalized Phrase-Structure Grammar.* Harvard University Press, Cambridge, Mass.
- Gibson, E. A. F. (1991) *A Computational Theory of Human Sentence processing: Memory Limitations and Processing Breakdown.* Doctoral Dissertation. Pittsburgh, Carnegie-Mellon University.
- Gibson, E., Pearlmutter, N., Canseco-González, E., and Hickok, G. (1996) Recency Preferences in the Human Sentence Processing Mechanism. *Cognition* 59, 23-59.
- Gilboy, E. and Sopena, J. (1996) Segmentational Effects in the Processing of Complex Noun Pronouns with Relative Clauses. In Carreiras, M., García-Albea, J., Sebastián-Gallés, N. (Eds.) *Languages processing in Spanish.* Lawrence Erlbaum Associates, New Jersey.
- Gol'cova, N. G. and Jankelevič, T. E. (1974) *Russkij jazyk s elementami praktičeskoj stilistiki i osnovami redaktirovanija* ('The Russian Language with Practical Stylistics and Proof-Reading'). Publishing House 'Nauka', Moscow.
- Gorrell, P. (1989) Establishing the Loci of Serial and Parallel Effects in Syntactic Processing. *Journal of Psycholinguistic Research* 18, 61-73.
- Gorrell, P. (1993) *Syntax and Parsing.* Cambridge, England: Cambridge University Press.
- Gorrell, P. (1996) Parsing Theory and Phrase-Order Variation in German V2 Clauses. *Journal of Psycholinguistic Research* 25, 135-156.

- Greenberg, G. (1987) Genitive of Negation and Infinitives as Subjects in Russian. *Chicago Linguistics Society 23: Papers from the 23rd Annual Regional Meeting of the Chicago Linguistics Society. Part I: The General Session.* Chicago, Chicago Linguistics Society.
- Haider, H. (1994) *Scrambling – What's the State of the Art?* Talk given at University of Stuttgart.
- Hale, K. (1983) Warlpiri and the Grammar of Non-Configurational Languages. *Natural Languages and Linguistic Theory* 1, 5-74.
- Hall, R. M. R. (1995) *Some Aspects of Poetic Meaning in a Non-Configurational Language.* Talk presented at the CUNY Colloquium Series. CUNY Graduate Center, December, 1995.
- Holden, K. & Krupp, M. (1987) Word Order in Russian Transitive Sentences. *Folia Slavica* 8 (2/3), 254-271.
- Huck, G. and Ojeda, A. (Eds.) (1987) *Discontinuous Constituency.* Syntax and Semantics, Vol. 20. Academic Press, Orlando.
- Inoue, A. (1991) *A Comparative Study of Parsing in English and Japanese.* Doctoral Dissertation. University of Connecticut, Storrs.
- Inoue, A. and Fodor, J. D. (1995) Information-Paced Parsing of Japanese. In Mazuka, R. and Nagai, N. (Eds.) *Japanese Sentence Processing.* Lawrence Erlbaum, Hillside, NJ.
- Janin, V. L. and Zaliznjak, A. A. (1986) *Novgorodskie gramoty na bereste. Iz raskopok 1977 - 1983 godov ('The Novgorod Birchbark Notes. Excavations from 1977 - 1983').* Publishing House 'Nauka', Moscow.
- Johnson, K. (1991) Object Positions. *Natural Language and Linguistic Theory* 9, 577-636.
- Junghanns, U. and Zybatow, G. (1995) Syntax and Information Structure of Russian Clauses. In Browne, W. et al. (Ed.) *The Fourth Annual Workshop on Formal Approaches to Slavic Linguistics, the Cornell Meeting.* Michigan Slavic Publications, Ann Arbor, 289-319.
- Kayne, R. (1994) *The Antisymmetry of Syntax.* M.I.T. Press, Cambridge, Mass.
- Kimball, J. (1973) Seven Principles of Surface Structure Parsing in Natural Languages. *Cognition* 2, 15-47.
- King, T. H. (1993) *Configuring Topic and Focus in Russian.* Doctoral Dissertation. Stanford University.
- King, T. H. (1995) *Configuring Topic and Focus in Russian.* CSLI Publications. Stanford University.
- Kondrashova, N. Yu. (1993) Agreement and Dative Subjects in Russian. In Avrutin, S., Franks, S. and Progovac, L. (Eds.) *The Second Annual Workshop on Formal Approaches to Slavic Linguistics, the MIT Meeting,* Michigan Slavic Publications, Ann Arbor, 255-285.
- Kondrashova, N. Yu. (1996) *The Syntax of Existential Quantification.* Doctoral Dissertation. University of Wisconsin-Madison.
- Konieczny, L., Scheepers, C. & Hemforth, B. (1994) Reanalyses vs. Internal Repairs: Non-Monotonic Processes in Sentence Perception. In Hemforth, B., Konieczny, L., Scheepers, C. & Strube, G. (Eds.) *First Analysis, Reanalysis, and Repair.* IIG-Berichte 8, 1-22.

- Lapteva, O. A. (1976) *Russkij razgovornyj sintaksis ('Russian Colloquial Syntax')*. Publishing House 'Nauka', Moscow.
- Lee, Y.-S. (1993) *Scrambling as Case-Driven Obligatory Movement*. Doctoral Dissertation. University of Pennsylvania, Philadelphia.
- Lee, Y.-S. & Santorini, B. (1994) Towards Resolving Webelhuth's Paradox: Evidence from German and Korean. In Corver, N. and van Riemsdijk, H. (Eds.) *Studies on Scrambling: Movement and Non-Movement Approaches to Free-Word Order Phenomena*. Mouton de Gruyter, Berlin.
- Mahajan, A. (1990) *The A/A-bar Distinction and Movement Theory*. Doctoral Dissertation, M.I.T., Cambridge, Mass.
- Mahajan, A. (1994) Toward A Unified Theory of Scrambling. In Corver, N. and van Riemsdijk, H. (Eds.) *Studies on Scrambling: Movement and Non-Movement Approaches to Free-Word Order Phenomena*. Mouton de Gruyter, Berlin.
- Mandelbaum, D. (1994) *Syntactic Conditions on Saturation*. Doctoral Dissertation, Graduate School and University Center, City University of New York.
- Marcus, M. (1987) Deterministic parsing and Description Theory. In Whitelock, P. et al. (Eds.) *Linguistic Theory and Computer Applications*, Academic Press, New York.
- Mitchell, D. C. (1984) An Evaluation of Subject-Paced Reading Tasks and Other Methods for Investigating Immediate Processes in Reading. D. Kieras & M.A. Just (Eds.) *New Methods in Reading Comprehension Research*, Hillsdale, NJ: Earlbaum.
- Mitchell, D. C. and Cuetos, F. (1991) *Restrictions on Late Closure: The Computational Underpinnings of Parsing Strategies in Spanish and English*. Unpublished manuscript.
- Mithun, M. And Miller, C. (1996) Grammatical Sketch: The Mohawk Language. In Maurais, J. (Ed.) *Quebec's Aboriginal Languages: History, Planning and Development*. Clevedon, England: Multilingual Matters Ltd., 159-173.
- Miyagawa, S. (1997) Against Optional Scrambling. *Linguistic Inquiry* 28, 1-26.
- Müller, G. and Sternefeld, W. (1993) Improper Movement and Unambiguous Binding. *Linguistic Inquiry* 24, 461-509.
- Neeleman, A. (1994) *Complex Predicates*. Doctoral Dissertation. University of Utrecht, the Netherlands.
- Ordoñez, F. (1994) *Postverbal Subjects in Spanish*. Ms., Graduate School and University Center, The City University of New York.
- Ostafin, D. M. (1986) *Studies in Latin Word Order: A transformational Approach*. Doctoral Dissertation, University of Connecticut, Storrs.
- Perelevssky, V. (1879) *The Slavic Grammar*. Moscow.
- Pesetsky, D. (1982) *Paths and Categories*. Doctoral Dissertation, M.I.T., Cambridge, Mass.
- Pollock, J.-Y. (1989) Verb Movement, UG and the Structure of IP. *Linguistic Inquiry* 20, 365-424.

- Praktičeskaja stilistika ruskogo literaturnogo jazyka (Practical Stylistics of the Russian Language)* (1970). Publishing House 'Nauka, Moscow.
- Pritchett, B. (1991) Head Positions and Parsing Ambiguity. *Journal of Psycholinguistic Research* 20, 251-270.
- Pritchett, B. (1992) *Grammatical Competence and Parsing Performance*. Chicago, University of Chicago Press.
- Rappoport, G. (1986) On Anaphor Binding in Russian. *Natural Language and Linguistic Theory* 4, 97-120.
- Reinhart, T. (1995) *Interface Strategies*. OTS Working Papers, Research Institute for Language and Speech, Utrecht University.
- Rizzi, L. (1986) Null Objects in Italian and the Theory of *pro*. *Linguistic Inquiry* 17, 501-557.
- Ross, J. (1967) *Constraints on Variables in Syntax*. Doctoral Dissertation, M.I.T., Cambridge, Mass.
- Rubin, E. (1994) *Modification: A Syntactic Analysis and its Consequences*. Doctoral Dissertation, Cornell University, Ithaca, NY.
- Rudin, C. (1988) On Multiple Questions and Multiple Wh-Fronting. *Natural Language and Linguistic Theory* 6, 455-501.
- Saito, M. (1985) *Some Asymmetries in Japanese and Their Theoretical Implications*. Doctoral Dissertation. M.I.T., Cambridge, Mass.
- Saito, M. (1992) Long-Distance Scrambling in Japanese. *Journal of East Asian Linguistics* 1, 69-118.
- Selkirk, E. (1995) Sentence Prosody: Intonation, Stress, and Phrasing. In J. Goldsmith (Ed.) *The Handbook of Phonological Theory*. Basil Blackwell, 550-569.
- Siewierska, A. (1984) *Phrasal Discontinuity in Polish*. *Australian Journal of Linguistics*, 4, 57-71.
- Sirotinina, O. B. (1965) *Porjadok slov v russkom jazyke ('Word Order in Russian')*. Saratov University Publishing House, Saratov.
- Stojanovic, D. (1997) *Theta-Role Assignment in On-Line Processing of a Free Word Order Language*. Poster presented at the the Sixth Annual Workshop on Formal Approaches to Slavic Linguistics, the University of Connecticut Meeting, Storrs.
- Tada, H. (1993) *A/A-bar Partition in Derivation*. Doctoral Dissertation. M.I.T. Cambridge, Mass.
- Truckenbrodt, H. (1995) *Phonological Phrases: Their Relation to Syntax, Focus, and Prominence*. Doctoral Dissertation. M.I.T., Cambridge, Mass.
- Uehara, K. (1997) *External Possessors in Japanese from Psycholinguistic Point of View: Some Sentence Completion Data*. Paper presented at the Conference on external possession and noun incorporation. University of Oregon, Eugene.
- Webelhuth, G. (1989) *Syntactic Saturation Phenomena and the Modern Germanic Languages*. Doctoral Dissertation, University of Massachusetts, Amherst.

- Weinberg, A. (1993) Parameters in the Theory of Sentence Processing: Minimal Commitment Theory Goes East. *Journal of Psycholinguistic Research* 22, 339-364.
- Vikner, S. (1994) Scandinavian Object Shift and West Germanic Scrambling. In Corver, N. and van Riemsdijk, H. (Eds.) *Studies on Scrambling: Movement and Non-Movement Approaches to Free-Word Order Phenomena*. Mouton de Gruyter, Berlin.
- Xie, J.-E. (1997) *Processing NP-Trace and Reflexives in Chinese*. Doctoral Dissertation, Graduate School and University Center, City University of New York.
- Yadroff, M. (1992) *Scrambling and Relativized Minimality*. Ms., Indiana University.
- Yamashita, H. (1996a) *Processing of Scrambling Sentences in Japanese and Types of Preverbal Information*. Talk given at the Ninth CUNY Conference on Human Sentence Processing, CUNY, New York.
- Yamashita, H. (1996b) *Scrambled Sentences and the Types of Preverbal Information Utilized in Processing of Japanese*. Ms., University of Illinois at Urbana-Champaign.
- Yearley, J. (1993) *Discontinuity in the Russian Noun Phrase*. Ms., University of Massachusetts, Amherst.
- Yokoyama, O. (1982) Russian Word Order and Empathy. *Chicago Linguistics Society 18: Papers from the 18th Annual Regional Meeting of the Chicago Linguistics Society. Part I: The General Session*. Chicago, Chicago Linguistics Society.
- Yokoyama, O. (1986) *Discourse and Word Order*. John Benjamins, Philadelphia.